

8x12 SunShed Greenhouse Building Assembly Manual Cedar Roof - T&G Model



Reversible Roof Lines



Thank you for purchasing an 8x12 SunShed Greenhouse Building from Outdoor Living Today. Please take the time to identify all the parts prior to assembly.

Safety Points and Other Considerations

Our products are built for use based on proper installation and normal residential use, on level ground. Please follow the instruction manual when building your shed and retain the manual for future maintenance purposes.

Some of the safety and usage measures you may wish to consider include:

- snow load ratings vary by geographical location. If heavy or wet snowfall occurs, it is advisable to sweep the snow off the roof(s).
- if the product is elevated, any structural and building code requirements are solely the customer's responsibility, and should be abided by.
- in high or gusty wind conditions it is advisable to keep the structure securely grounded.
- have a regular maintenance plan to ensure screws, doors, windows and parts are tight.

Customer agrees to hold Outdoor Living Today Partnership and any Authorized Dealers free of any liability for improper installation, maintenance and repair.

In the event of a missing or broken piece, simply call the Outdoor Living Today Customer Support Line @ 1-888-658-1658 within 30 days of the delivery of your purchase. It is our commitment to you to courier replacement parts, free of charge, within 10 business days of this notification. Replacement parts will not be provided free of charge after the 30 day grace period.

What to do before my Shed arrives?



- Become familiar with this assembly manual and determine if you can complete the project yourself or will require a professional contractor.



- One helper is recommended to assist in constructing your shed. It generally takes two people over two days to assemble a shed. If you're hiring a contractor, their rate should be in line with that duration of work.



- Clear the construction area and ensure a clear pathway for delivery when the freight company arrives. Remove all debris: roots, grass, rocks, etc.



- Excavate the site. Contact your local utilities company to ensure there are no gas or electric lines buried in the area before digging.



- Decide on the type of foundation you will be using:
 - Concrete slab, or
 - 4-6 inches of crushed gravel with paver stones or 4x4 stringers.

You can find the footprint for your shed on Page 3 of your Assembly Manual.

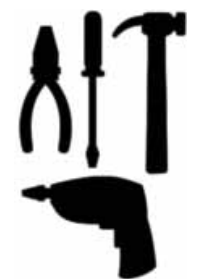

- If doing the assembly yourself, have all the necessary tools ready to go and in working condition. A list of required tools can be found after the parts list.

Foundation Types for 8x12 Garden Shed

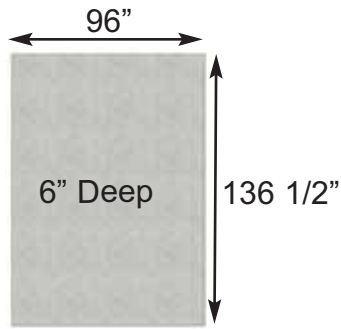

Concrete Foundation

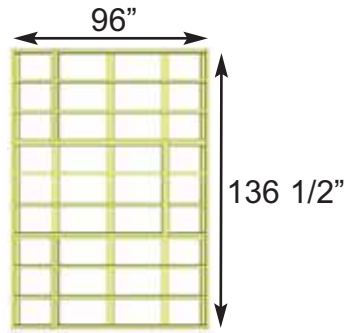

Floor Frame



Completed Foundation

Concrete Slab Foundation:

- Slab must be at least the same size as assembled floor frame (136 1/2" x 96") or larger.
- 6" Deep foundation.
- 1.7 Cubic Yards of concrete required.
- A concrete slab will have the longest durability out of your foundation options.

Once level, a concrete slab is the easiest surface to build on.

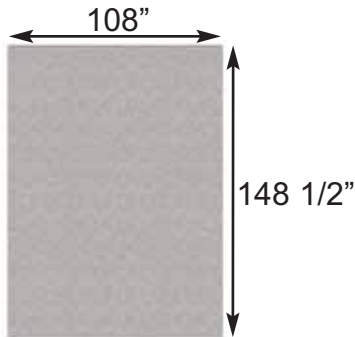

Gravel Foundation

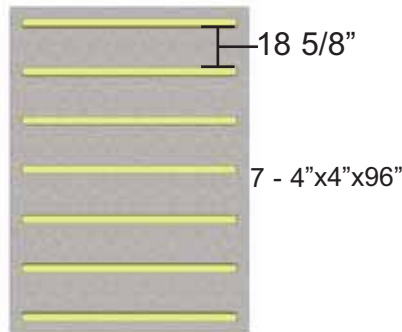

Gravel Foundation with treated stringers



Completed Foundation

Gravel with 4x4 Pressure Treated Stringers:

- Excavate at least 6" deep, and 6" wider than floor frame on each side.
- 2.1 Cubic Yards of gravel required, approximately 19 wheelbarrows.
- 7 - 4x4 Pressure Treated Stringers 8' long required.
- Evenly spaced, with one at each end of floor frame.

Saves money on materials, easy to level and work with.

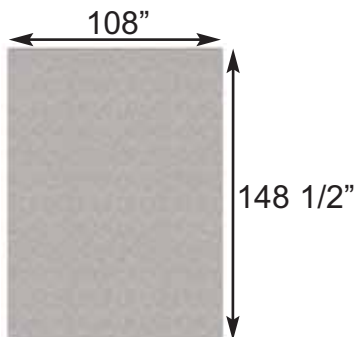

Gravel Foundation

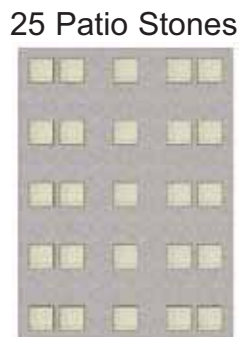

Gravel Foundation with Patio Pavers

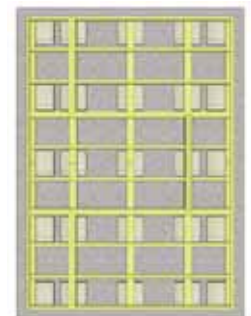

Completed Foundation

Gravel with Patio Paver Stones:

- Excavate at least 6" deep, and 6" wider than floor frame on each side.
- 2.1 Cubic Yards of gravel required, approximately 19 wheelbarrows.
- 25 patio pavers (8" x 8" or larger).
- Center patio paver stones underneath floor runners and underneath seams in floor joists.

Patio paver stones are widely available from most landscape stores.

Thank you for purchasing our 8x12 SunShed Greenhouse Building.
Please take the time to identify all the parts prior to assembly.

A. Floor Section

- 3 - 45 1/2" x 75" - Floor Joist Frames (Interior Joist Unattached)
- 3 - 45 1/2" x 21" - Floor Joist Frames (Interior Joists Attached)
- 6 - 1 1/2" x 3 1/2" x 71 3/4" - Floor Joists
- 3 - 45 3/8" x 74 7/8" - Floor Plywood
- 3 - 45 3/8" x 20 7/8" - Floor Plywood
- 10- 1 1/2" x 3 1/2" x 68 3/16" - Floor Runners

B. Wall Section

Main Wall Panels

- 4 - 34 1/8" x 84" - Solid Wall Panels
- 4 - 1 1/2" x 2 1/2" x 34 1/8" - Wall Plates
- 1 - 45 1/2" x 84" - Solid Wall Panels
- 1 - 1 1/2" x 2 1/2" x 45 1/2" - Wall Plates
- 2 - 45 1/2" x 84" - Window Wall Panels
- 3 - 45 1/2" x 75" - Double Window Walls
- 1 - 12" x 73" - Narrow Wall Panel
- 1 - 31 1/2" x 72" - Dutch Door - 2pcs (42" and 30" high)
- 1 - 45 1/2" x 9" - Wall Extender
- 2 - 3/4" x 3 1/2" x 60" - Horizontal Wall Extender Brace (front/back)
- 2 - 3/4" x 3 1/2" x 30" - Horizontal Wall Extender Brace (front/back)
- 2 - 3/4" x 3 1/2" x 48 1/2" - Horizontal Wall Extender Brace (side)
- 2 - 3/4" x 3 1/2" x 82 3/4" - Horizontal Wall Extender Brace (side)

Door Jamb, Header & Door Stops

- 1 - 1 1/2" x 3 1/8" x 73" - Vertical Door Jamb
- 1 - 2" x 3 1/8" x 45 1/2" - Door Header
- 2 - 1/2" x 2 1/2" x 72" - Interior Vertical Door Stops

Gable Walls

- 2 - Front and Rear Gable Walls - Triangular shaped
(33 3/4 degrees on 1 side / 22 1/2 degrees on other)

Top Wall Plates

- 2 - 3/4" x 2 1/2" x 65 3/4" - Short Side - 22 1/2 degree cut on edge
- 2 - 1 1/2" x 2 1/2" x 65 3/4" - Tall Side - 33 3/4 degree cut on edge
- 2 - 3/4" x 2 1/2" x 73 3/4" - Front & Rear
(33 3/4 degrees on 1 end / 22 1/2 degrees on other)

C. Rafter Section

- 9 - 1 1/2" x 3 1/2" x 77 3/4" - Long Roof Side Rafters (22 1/2 degrees)
- 9 - 1 1/2" x 3 1/2" x 37 3/4" - Short Roof Side Rafters (33 3/4 degrees)

- 1 - 3/4" x 4 5/8" x 52 1/2" - Ridge Boards (long roof side)
- 1 - 3/4" x 4 5/8" x 84" - Ridge Boards (long roof side)
- 1 - 3/4" x 5 1/8" x 52 1/2" - Ridge Boards (short roof side)
- 1 - 3/4" x 5 1/8" x 84" - Ridge Boards (short roof side)
- 3 - 3/4" x 3 1/2" x 72" - Gussets (angle cut on both ends)

Soffits

- 2 - 1/2" x 3 1/2" x 68 1/4" - Short Roof Side
- 2 - 1/2" x 4 1/2" x 68 1/4" - Long Roof Side

D. Roof Section

- 2 - Right Side Roof Panels (51" x 40 1/2")
- 2 - Center Roof Panels (45 1/2" x 40 1/2")
- 2 - Left Side Roof Panels (51" x 40 1/2")
- 4 - 3/4" x 1 1/2" x 34" - F&R Facia Nailing Strips
- 12 - 3/4" x 3/4" x 44 1/2" - Polygal Support Cleats
- 3 - 1/2" x 2 1/2" x 41 1/2" - Caps for Polygal
- 2 - 1/2" x 5 1/2" x 41 1/2" - Outside Caps for Polygal (w nailing strip)
- 2 - 1/2" x 4 1/2" x 41 1/2" - Caps for Polygal
- 6 - 20 1/4" w x 44" - Polygal Panels

E. Miscellaneous Section

Bottom Skirting

- 7 - 1/2" x 4 1/2" x 45 1/4" - Bottom Skirting Long
- 4 - 1/2" x 4 1/2" x 34 1/8" - Bottom Skirting Short

Corner & Wall Trim

- 2 - 5/8" x 2 1/2" x 75" - Filler Trim Short Wall Side
- 2 - 5/8" x 2 1/2" x 84" - Filler Trim Tall Wall Side
- 2 - 1/2" x 4 1/2" x 82" - Corner Trim Short Wall Side
- 2 - 1/2" x 4 1/2" x 87" - Corner Trim Tall Wall Side
- 3 - 1/2" x 2 1/2" x 87" - Front Door Trim & Rear Wall Seam Trim
- 5 - 1/2" x 2 1/2" x 88" - Tall Wall Vertical Trim
- 4 - 1/2" x 2 1/2" x 79" - Short Wall Vertical Trim
- 1 - 1/2" x 2 1/2" x 32" - Horizontal Door Trim (above Door)
- 1 - 1/2" x 2 1/2" x 8 3/4" - Horizontal Narrow Wall Trim (above Wall)
- 2 - 1/2" x 4 1/2" x 85 1/2" - Hor.Gable Trim (F & R) Angle cut 1 end

Facia Trim

- 2 - 3/4" x 3 1/2" x 78 3/4" - Angle Cut Front/Rear Facia Trim
- 2 - 3/4" x 3 1/2" x 38 1/4" - Angle Cut Front/Rear Facia Trim
- 4 - 3/4" x 3 1/2" x 71 1/2" - Side Facia
- 2 - Facia Detail Plates (Sides)
- 2 - Pentagon Detail Plates (Front and Back Facia)
- 2 - Triangular Corner Gable Trim Pieces (L/R) Found in Gable - see step 76

Filler Shingles (5 1/2" wide)

- 8 - Long Shingles
- 4 - Short Shingles

Roof Ridge Caps (V-shaped)

- 21 long Main & 1 -10" Center Ridge Caps

Flower Boxes

- 5 - Flower Box Kits

Potting Shelves

- 3 - 45" - Long Potting Shelves
- 1 - 41" - Short Potting Shelf
- 4 - 1 1/2" x 2 1/2" x 38" - Potting Shelf Legs

Window Inserts

- 2 Reg. Window Inserts
- 6 Small Window Inserts
- 2 Reg. Window Trim Pkgs: 1 x 24 1/16" Top, 3 x 23" Side & Bottom
- 6 Narrow Window Trim Pkgs: 1 x 19 7/8" Top, 2 x 21 7/16" Sides, 1 x 18 3/4" Bottom

****Miscellaneous Pieces**

- 1 pc - Spare Wall Siding
- 2 pcs - Spare Shingles- use to shim door, etc

Note: All Trim, Facia and Bottom Skirting pieces will be positioned rough face out when installed.

8x12 SUNSHED HARDWARE SHEET

Hardware Kit (Provided)

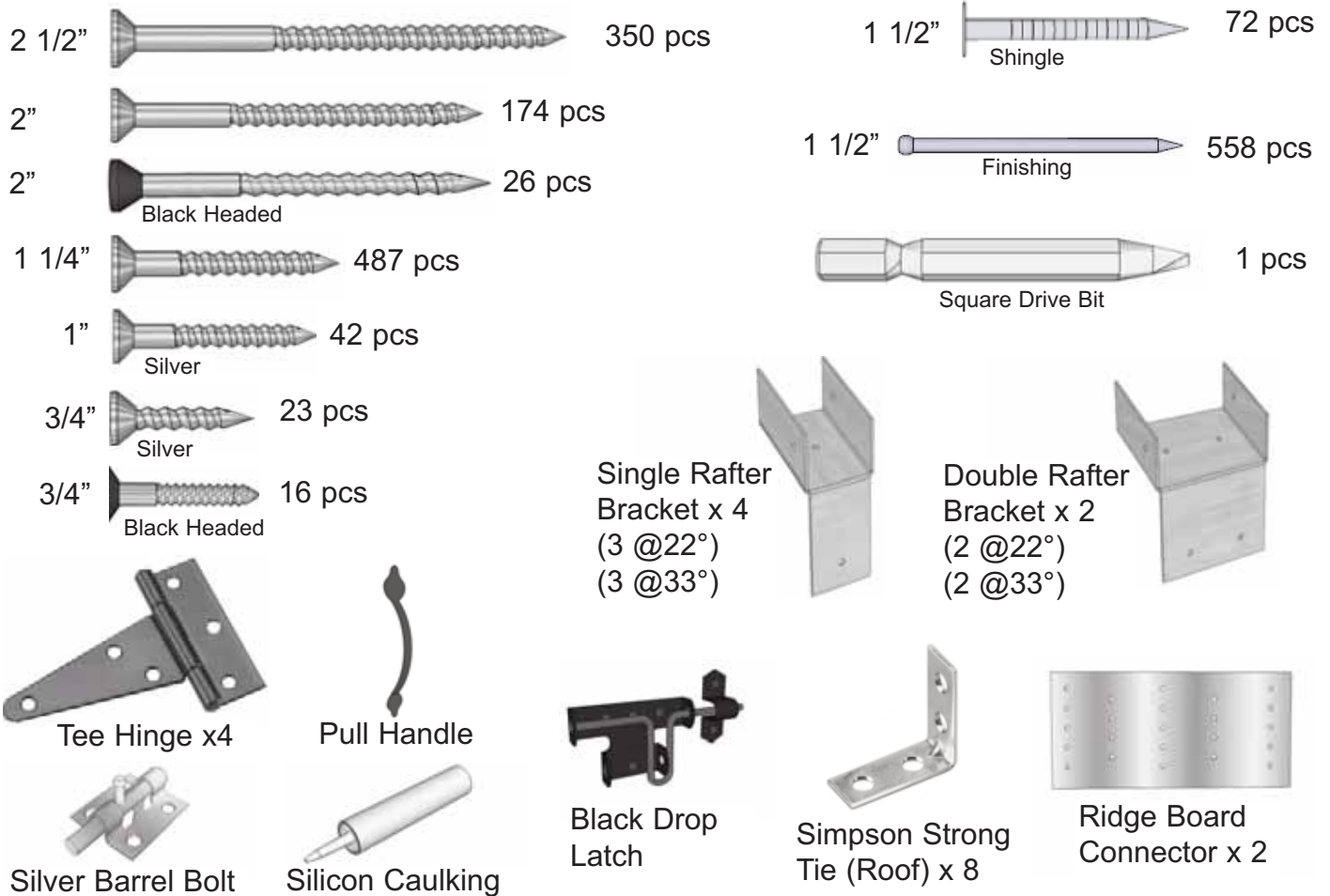

Tools Required (Not Provided)



Safety Equipment Required (Not Provided)



Before/During Assembly:

- 1.) Paint each face and edge of your plywood floor with a latex exterior paint.
- 2.) Caulk wall seams if gaps appear.
- 3.) Caulk around window framing.
- 4.) Caulk perimeter between floor plywood and bottom wall plate.
- 5.) Caulk channels in lap siding at the top of your door above the trim, just a drop in each channel.
- 6.) Caulk edge of door threshold (if applicable).
- 7.) Optional: Install a Sill Gasket between floor runners and foundation.
- 8.) Optional: Install an 8" strip of roofing paper below Cedar Ridge Caps for Cedar Roof Sheds.

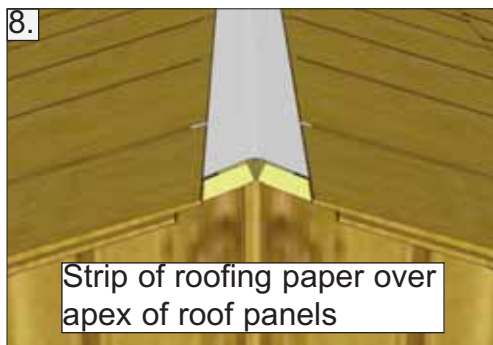
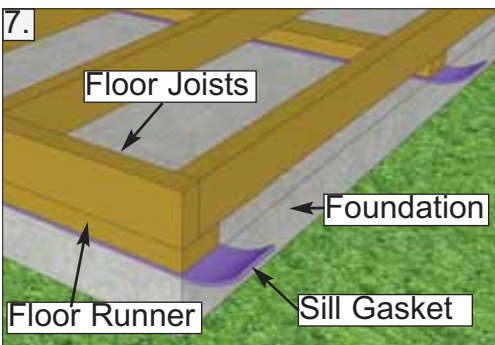
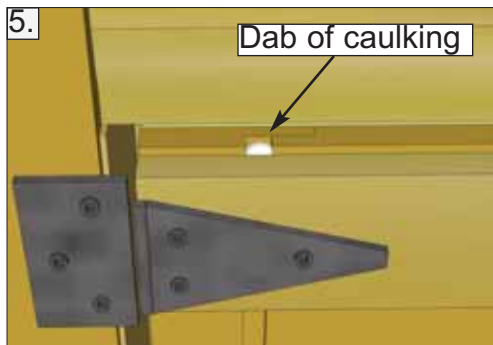
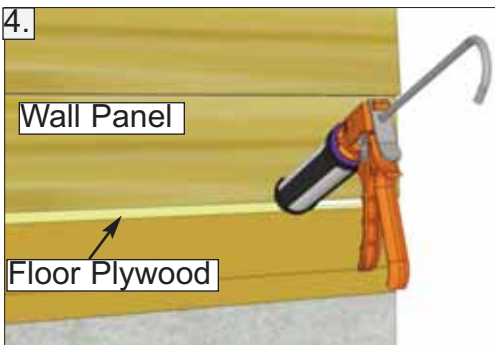
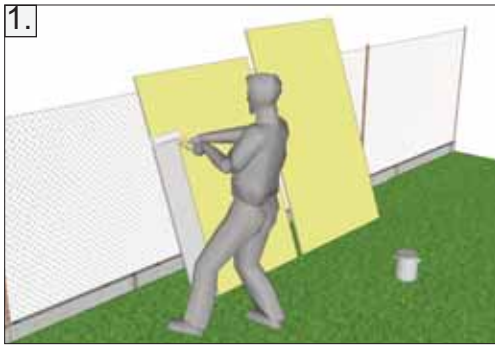

Routine Maintenance:

- Routinely check all fasteners are tight (ex. Door Hinges, Nails)
- Brush off dirt from walls.
- Brush off snow from roof regularly.
- Routinely remove needles and leaves from roof.

Painting/Staining

- Your cedar shed, if left untreated, will weather to a silvery grey colour.
- Painting or staining your structure is highly recommended and will prolong the life of your shed.
- You do not need to wait to paint or stain your shed, the wood in your kit has been dried and can be stained or painted immediately.
- Consult your local paint store for the best paint or stain for cedar.
- Optional: stain the inside of your shed. (Note: this will remove the fresh cedar smell.)

A. Floor Section

Exploded view of all parts necessary to complete Floor Section. Identify all parts prior to starting. Note: Floor Footprint is 96" wide x 136 1/2" deep.

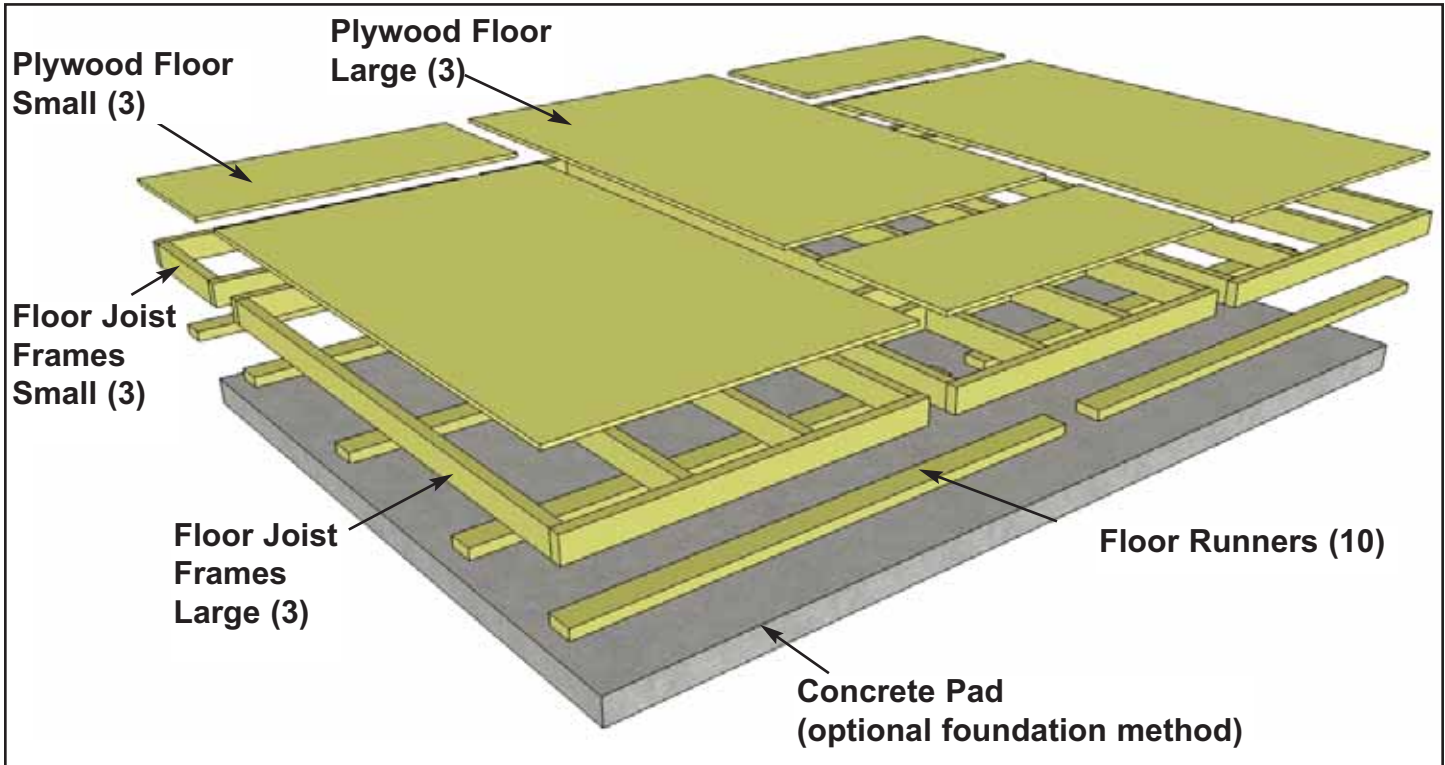

You can find the Square Drive Bit for the screws in with the Hardware Kit Bag.

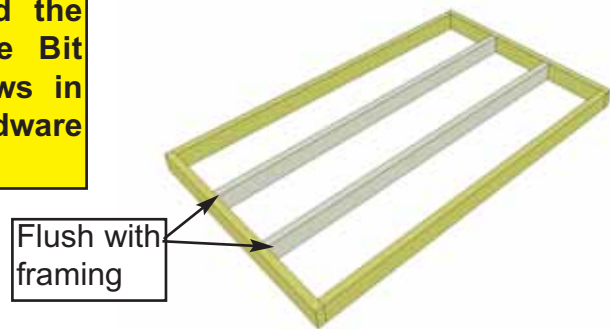

1. Lay out a **Large Floor Joist Frame** and 2 **Floor Joists** as illustrated above. Position Joists equally in Floor Joist Frame. Position Joists flush with framing.

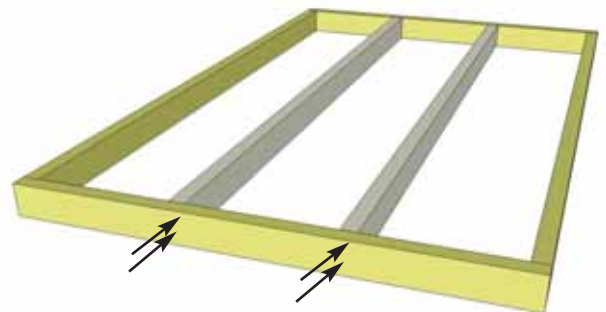
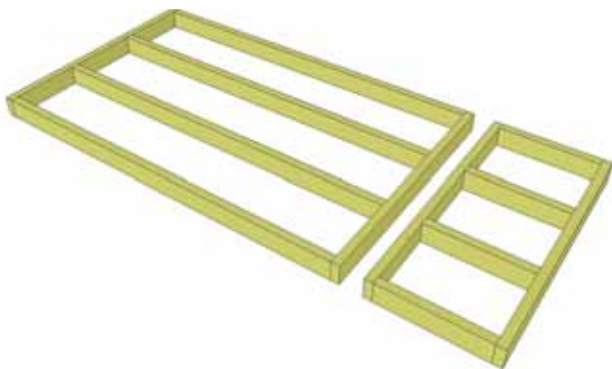

2. Use a Small Floor Joist Frame as a template to determine joist position. When correctly positioned, attach each Joist with 4 - 2 1/2" screws (2 per end). **You can find the Square Drive Bit for the screws in with the Hardware Kit Bag.**

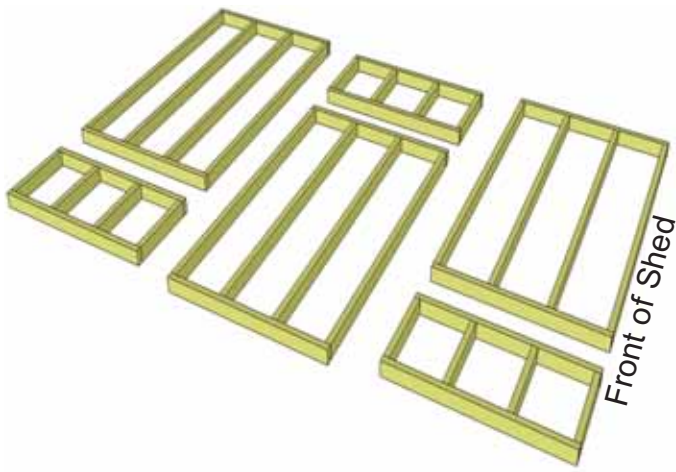

3. Lay out completed **Floor Joist Frames** as illustrated. There are 3 larger and 3 smaller Frame Sections. The Footprint for the floor when attached together will be 96" wide x 136 1/2" deep.

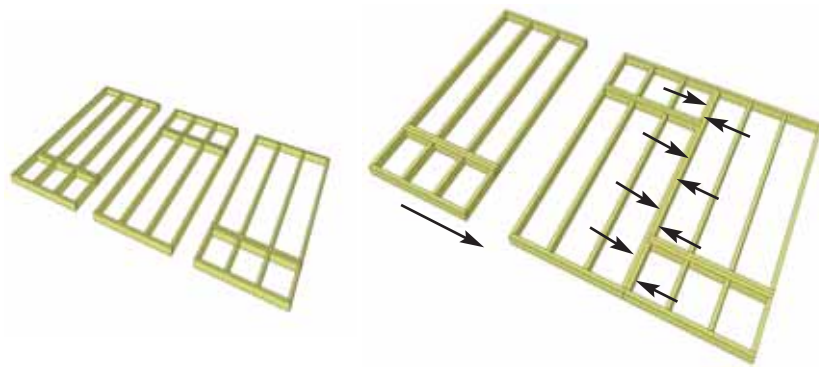

5. Complete all large and small frame attachments. Screw each completed section together with 8 - 2 1/2" screws.

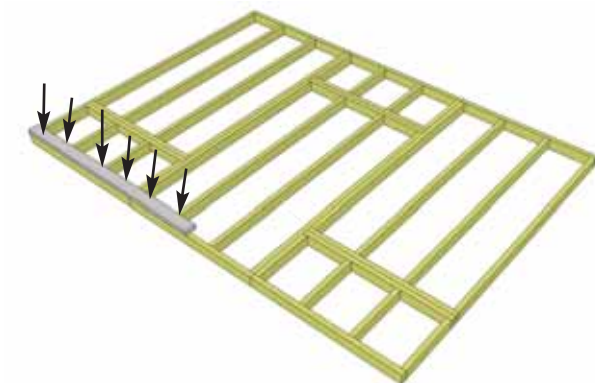

7. Attach **Floor Runners** to completed floor frame. There are 2 floor runners per 136 1/2" side and 5 completed runners in total. Use 6 - 2 1/2" screws per Runner.

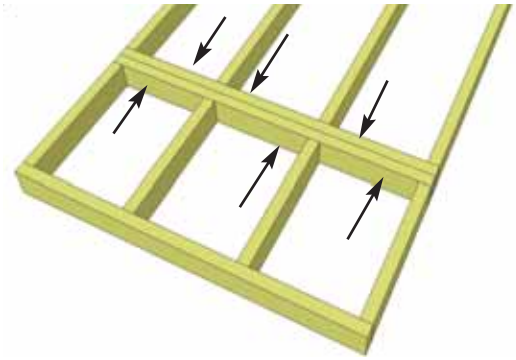

4. Attach each large and small floor joist frame together with 6 - 2 1/2" screws per section.

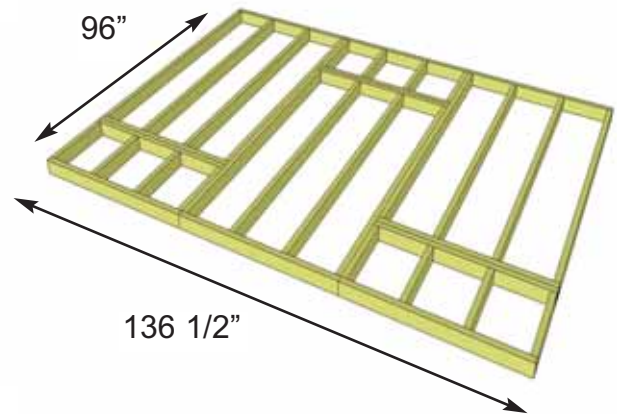

6. When completed, your floor footprint should be 96" wide x 136 1/2" deep.

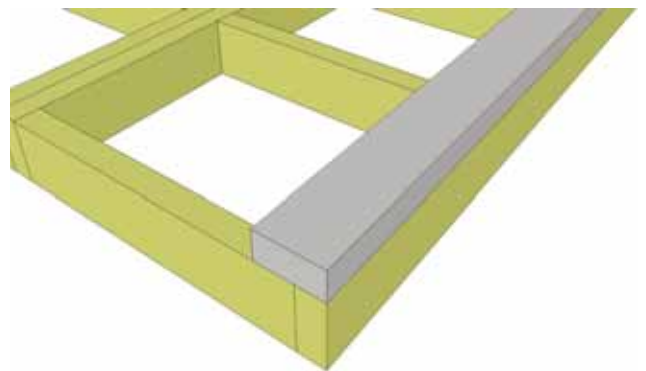

8. Make sure Runners are flush with outside of framing, not overhanging.

Foundations



Note: The floor will be flipped over and floor runners will sit on your foundation. It is important to note that having a level foundation is critical. Choosing a foundation will vary between regions. Typical foundations can be concrete pads or patio stones positioned underneath the floor runners.

9. Complete all Floor Runners.

10. With Floor Runners attached, carefully flip the floor over and place on your foundation. **Caution:** you will need 2 people to assist you. Be careful when laying floor down not to bend or twist floor. When in place, level floor completely.

Concrete Slab Foundation

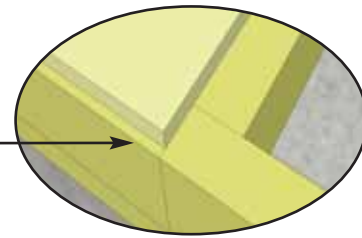
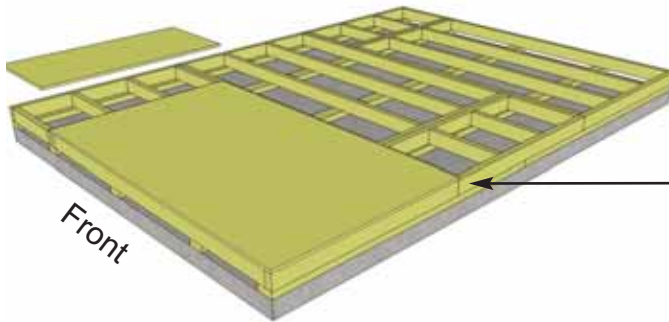
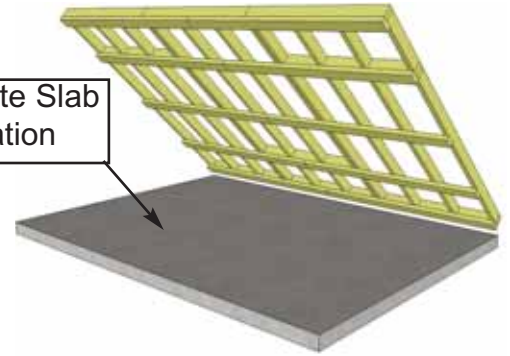

11. Position **Plywood Floor** pieces (6) on top of completed Floor Joists. The Plywood is cut slightly smaller than floor framing and will sit slightly back from outside edge. Keep plywood seams tight.

12. With Plywood positioned correctly on floor framing, attach with 1 1/4" screws. Use screws every 16".

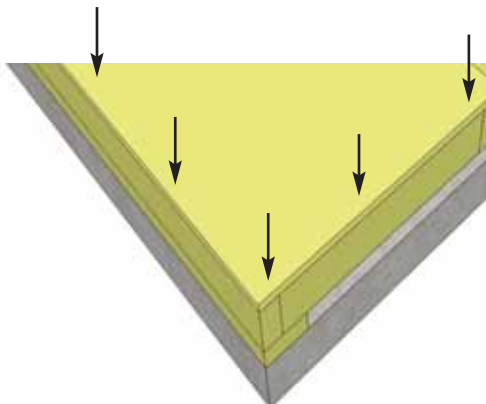
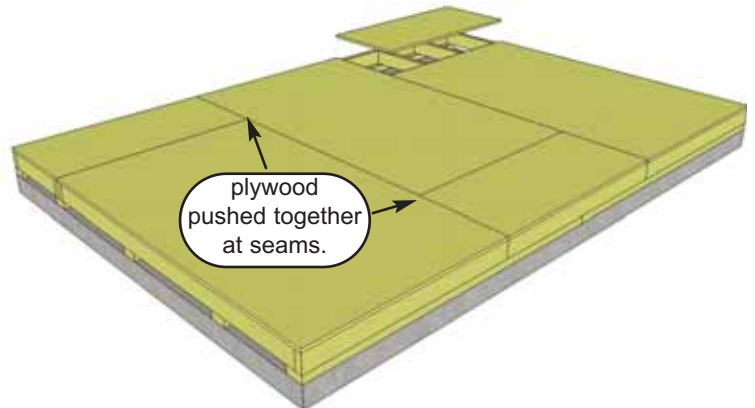

Hint: Use a chalk line to mark location of floor joists to determine screw placement.



B. Wall Section

Exploded view of all parts necessary to complete Wall Section. Identify all parts prior to starting.

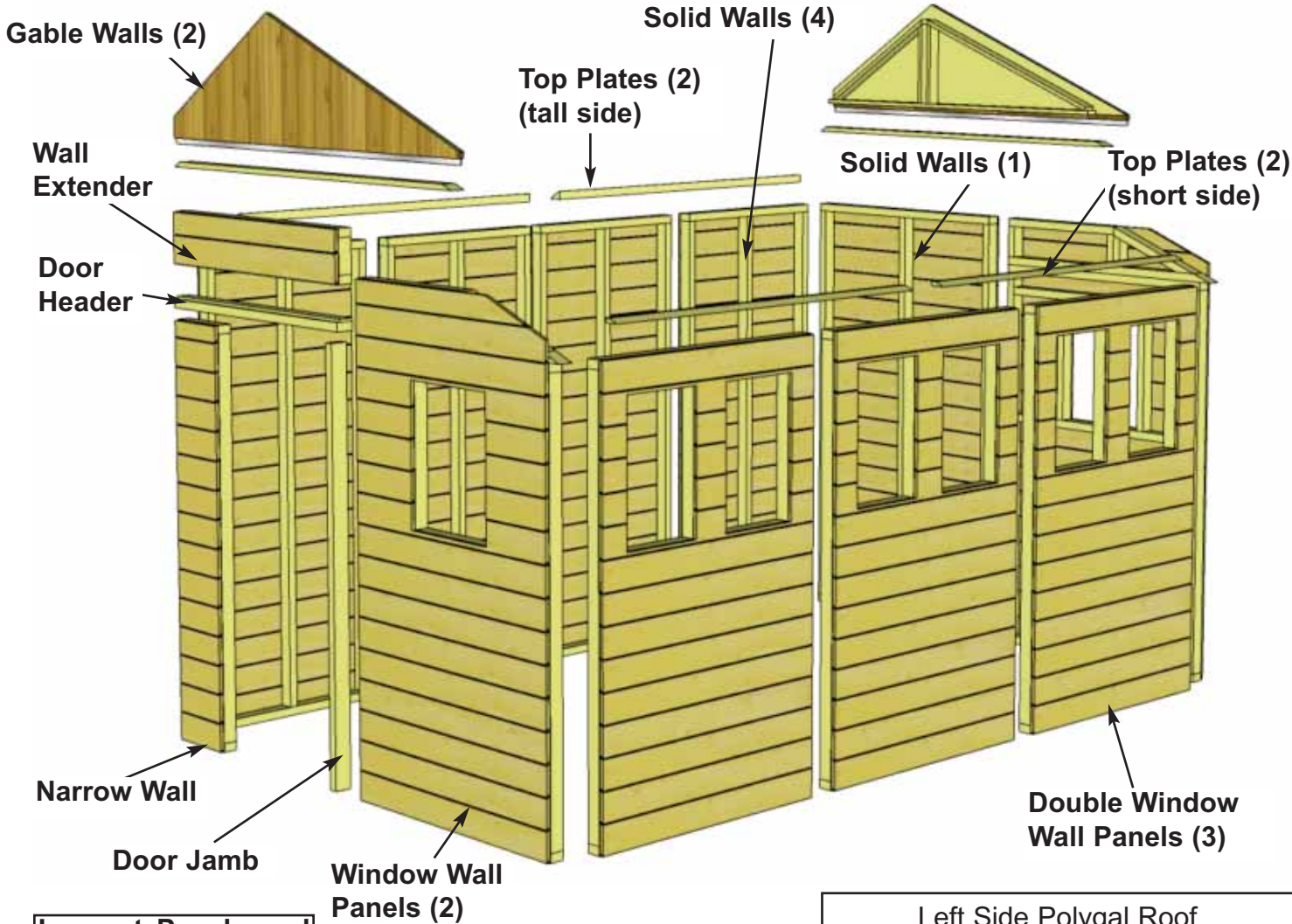

Lay out Panels and Pieces as illustrated below.

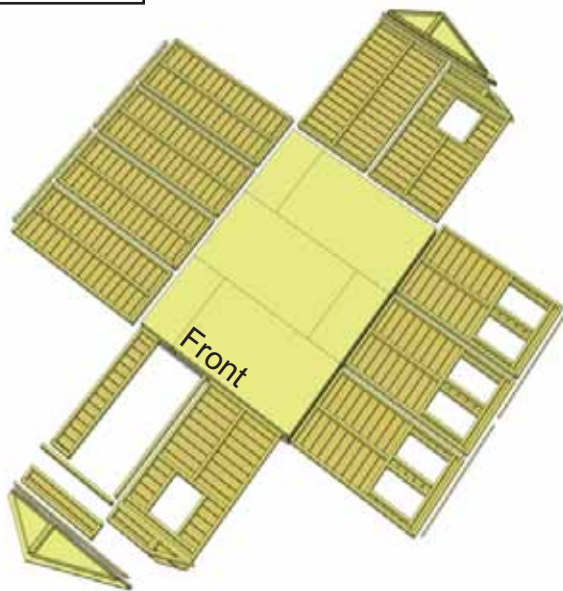

Left Side Polygal Roof Panel Orientation

Labels for the roof panel orientation diagram:

- Front

Important: If you prefer Polygal Roof Panels on left side when facing front, position wall panels as illustrated above. Follow general assembly directions but note opposite orientations.

Important:
Pilot hole ALL 2x3 Wall Studs with 1/8" drill bit prior to screwing. This will make it much easier to attached together.

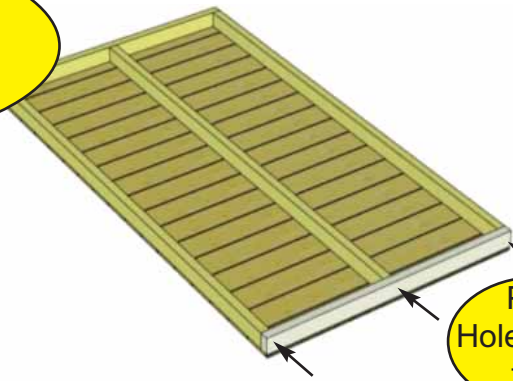
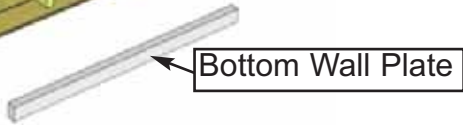

Pilot Hole Plate first.

13. Starting with **Solid Wall Panels**, carefully lay panel face down. Position and attach **Wall Plate** (1 1/2" x 2 1/2" x 45 1/2") to bottom of studs of each wall panel with 3 - 2 1/2" screws. Position so plates are flush with framing.

14. Starting at the Rear Left Side, position a **Solid Wall Panel** on top of plywood floor. The Wall Panel bottom framing will sit flush with floor framing. Wall siding will overhang the floor.

Important: Make sure all walls are aligned in their upright position. If not, water may leak into your shed. Unsure if panel is facing up or down? check siding on window wall panel to match alignment, or keep track of your recently attached bottom plates.

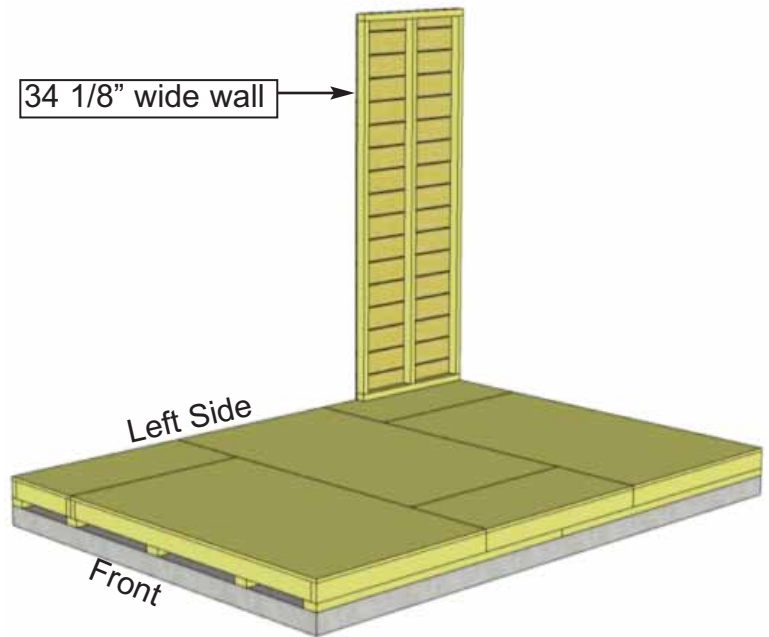

Do Not Attach Walls To Floor until Step 28.

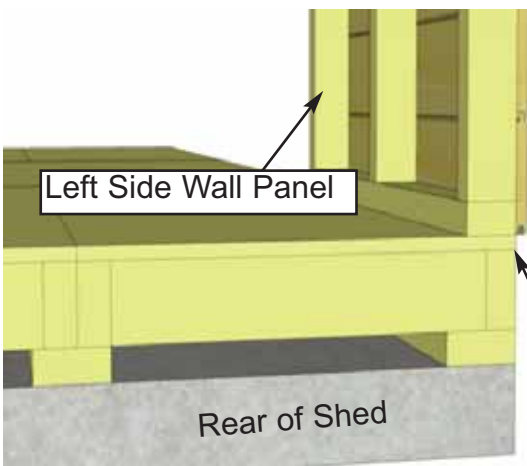

Outside 2x3 framing of wall panel is flush with outside of floor framing when properly aligned.

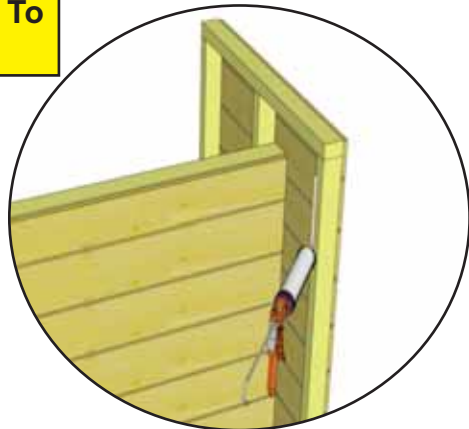

Optional: Caulking seams will help prevent moisture from entering your shed. Caulking is included to complete Polygal Windows only. Additional Caulking may be required.

15. The side panels will sit flush with floor framing in the corners, with the rear panels sandwiched between them. **Note:** Siding will overhang the floor by approx. 5/8".

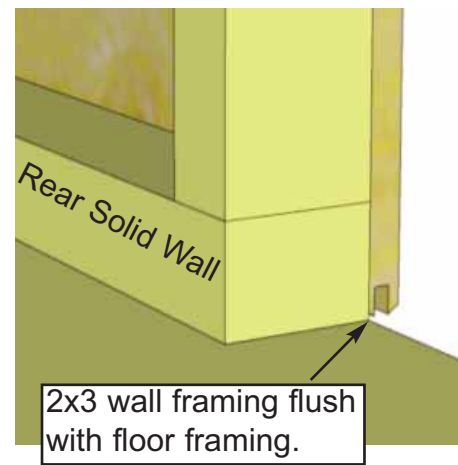
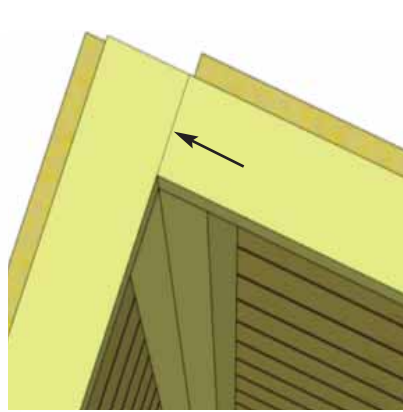
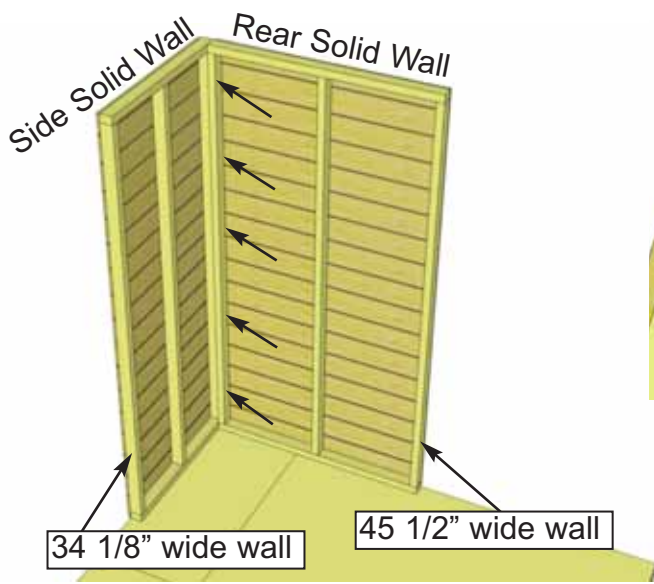

16. Position rear **Solid Wall** on plywood floor. Butt both vertical wall studs of side and rear walls together and attach with 5 - 2 1/2" screws. Screw at the bottom, middle and top of stud to secure. **Important:** Left Side walls are 34 1/8" wide and Rear walls are 45 1/2" wide.

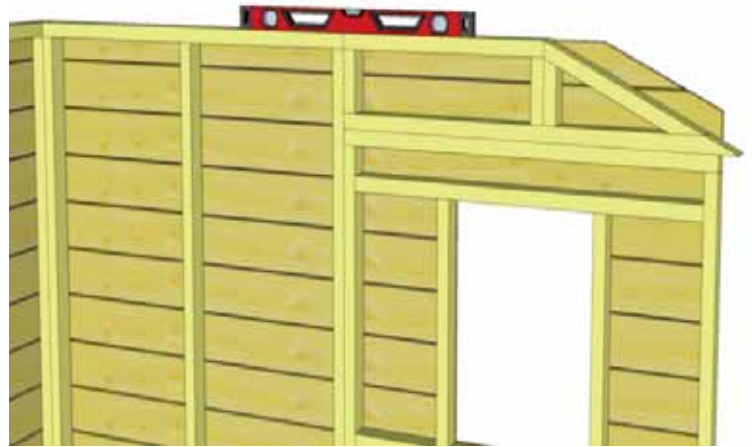
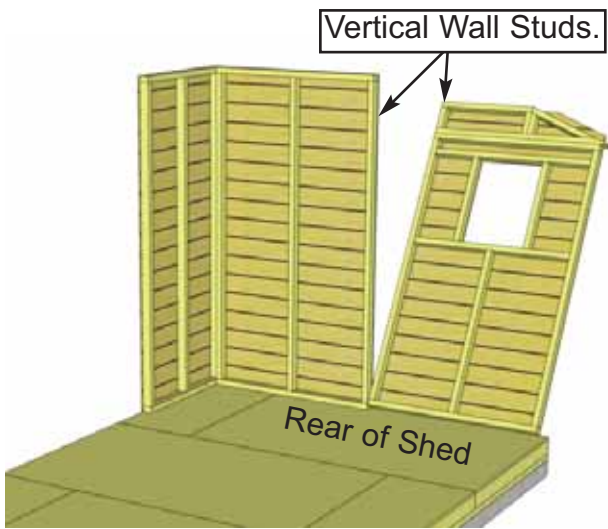

17. With the corner wall attachment complete, position the **Rear Window Wall Panel** so vertical wall studs line up evenly. Use a level to confirm solid and window walls are the same height.

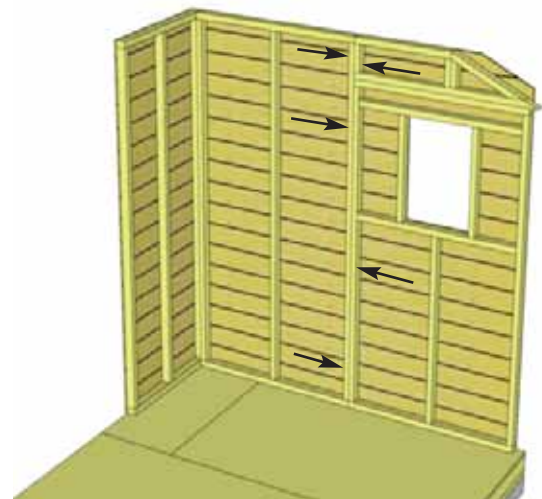
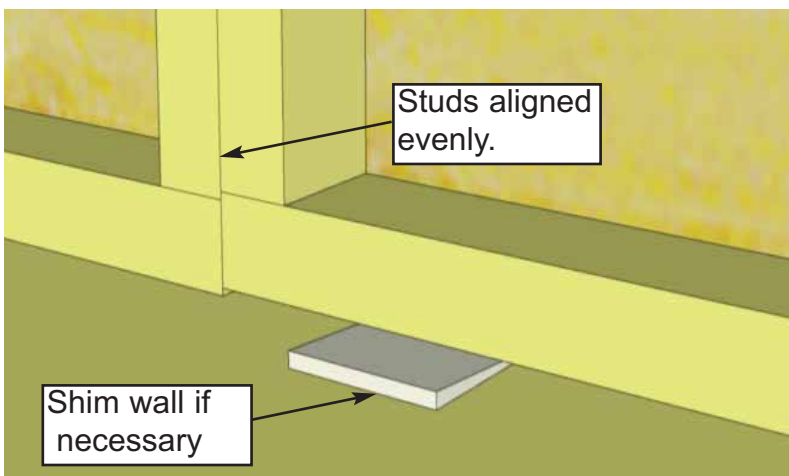

18. With walls positioned correctly, attach Rear Window Wall Panel to Solid Wall Panel with 5 - 2 1/2" screws.

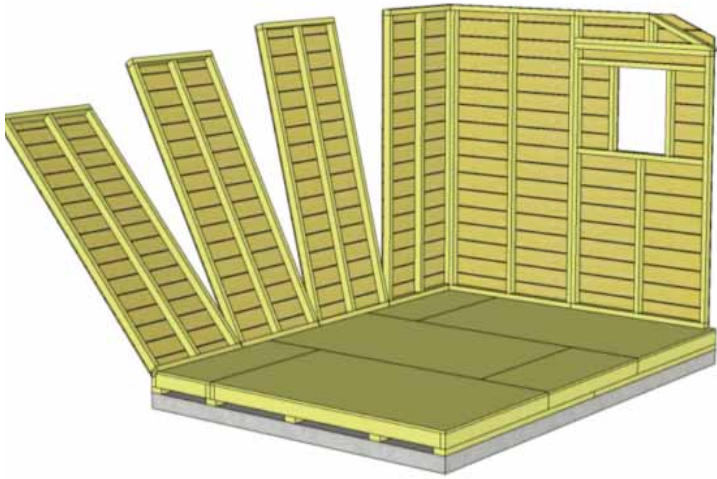

19. Locate **3 Solid Side Walls** and position on left side.



20. Position and secure Wall Panel studs together as per **Step 18**.

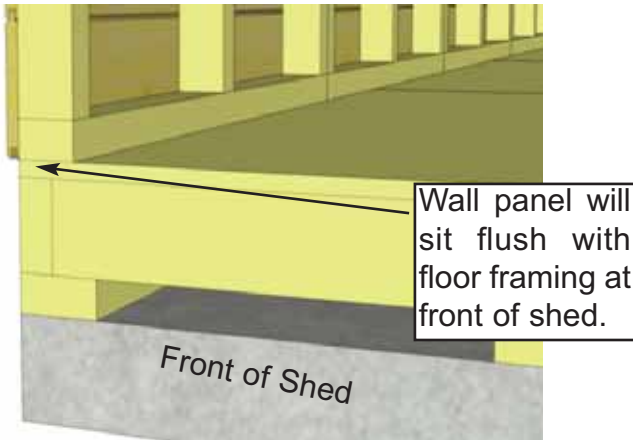

21. Front Side Wall Panel will sit flush with floor framing in corner when positioned correctly. Position Right Side Double Window Wall on floor.

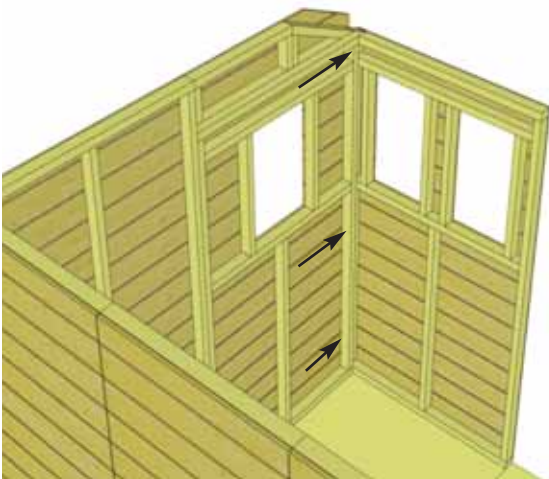

22. Position and secure Wall Panel studs together with 3 - 2 1/2" screws. Locate and position remaining Double Window Walls on floor.

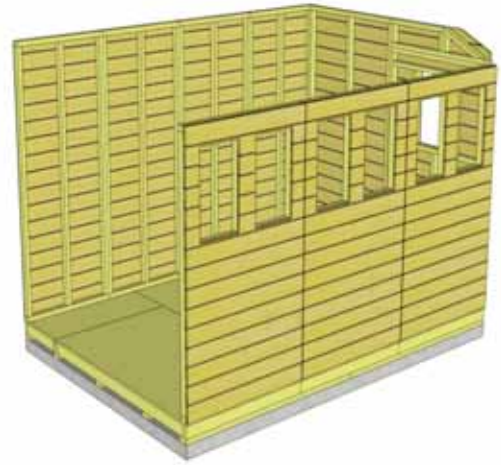

23. Position remaining Double Window Walls and attach as per **Step 20**.



24. Place 2nd **Window Wall Panel** in front and attach as per **Step 16**.

25. Position and attach **Narrow Wall Panel** to left side wall stud with 3 - 2 1/2" screws as per **Step 22**. **Note:** Narrow Wall is 73" high.

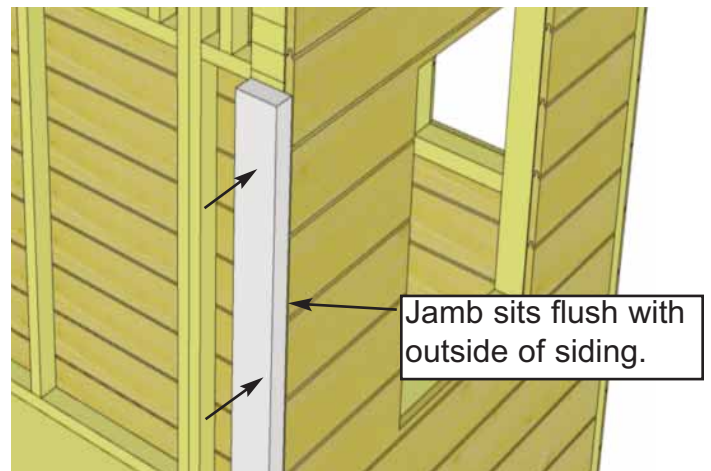

26. Locate **Vertical Door Jamb** (1 1/2" x 3 1/8" x 73") and position flush against right wall panel stud. The Jamb is 3 1/8" wide and will sit **flush to outside of wall siding**. When positioned correctly, secure Jamb using 4 - 2 1/2" screws.

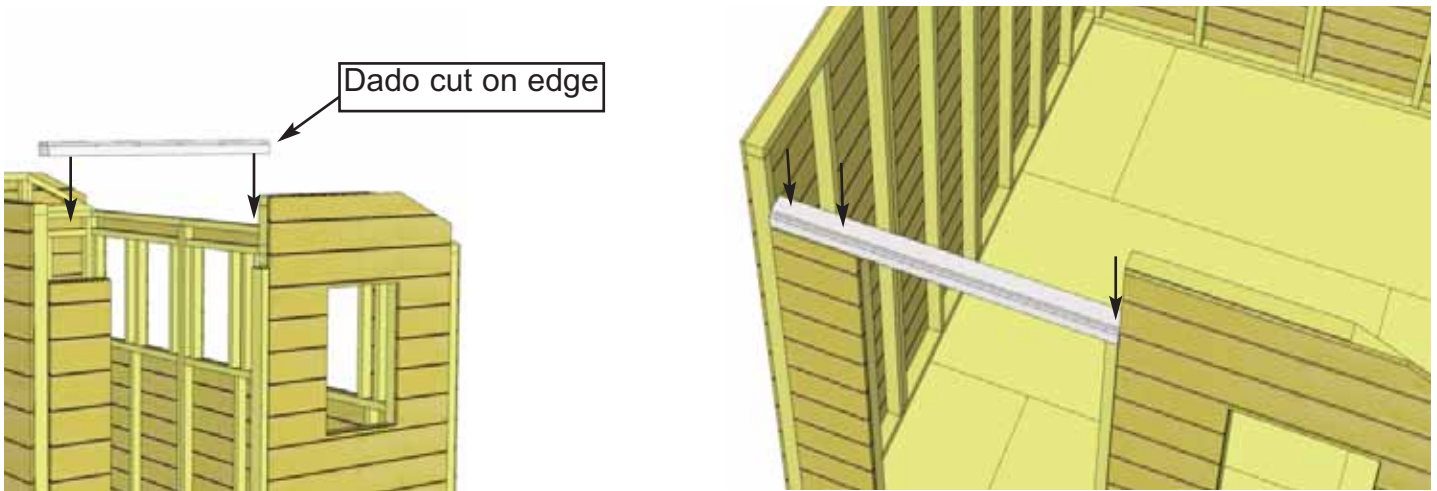

27. Position and attach the **Door Header** (2" x 3 1/8" x 45 1/2") to Door Jamb and Narrow Wall Panel top framing. Header should sit flush with Door Jamb and Outside of Narrow Wall Panel Siding. Attach with 3 - 2 1/2" screws.

Confirm 32" wide Door Opening at bottom.

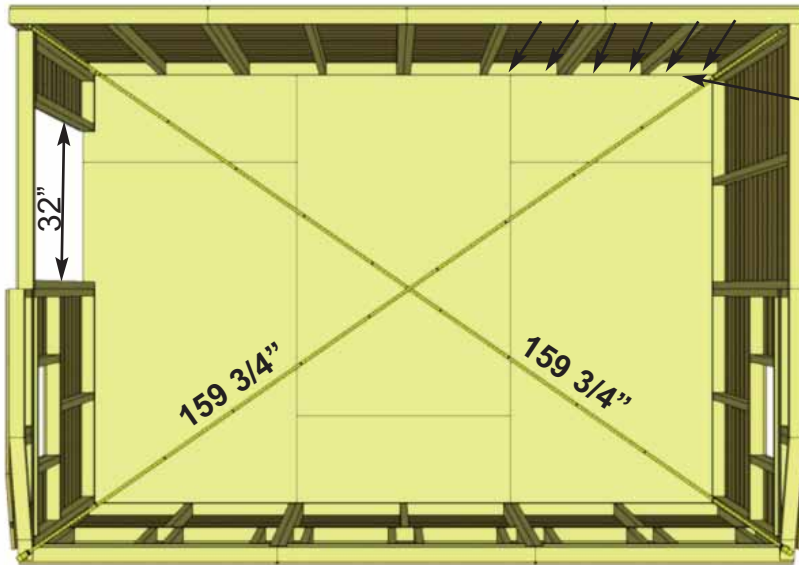

Angle screws into perimeter Floor Joists.

Advice: Prior to fastening walls and installing rafters, take time to confirm your walls are level, square and plumb.

Measure diagonal at top and bottom of walls corner-to-corner. This should be approximately 159 3/4". More importantly, if measurements are not within 1/4", your walls are not square. Adjusting now will make it easier to do the roof section later.

28. When all walls are attached together, check alignment with the floor. Bottom wall framing should sit flush with outside of floor frame. When positioned correctly, fasten bottom wall plates to floor using 4 - 2 1/2" screws per wall panel.

Important: If walls are not lining up and appear higher or lower than each other, your floor may not be LEVEL. Please check the level of your floor. You may need to make slight adjustments to level your floor before proceeding.

Optional: Caulking seams will help prevent moisture from entering. Caulking is included to complete Polygal Windows only. Additional Caulking may be required.

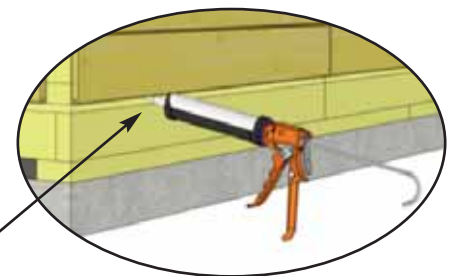

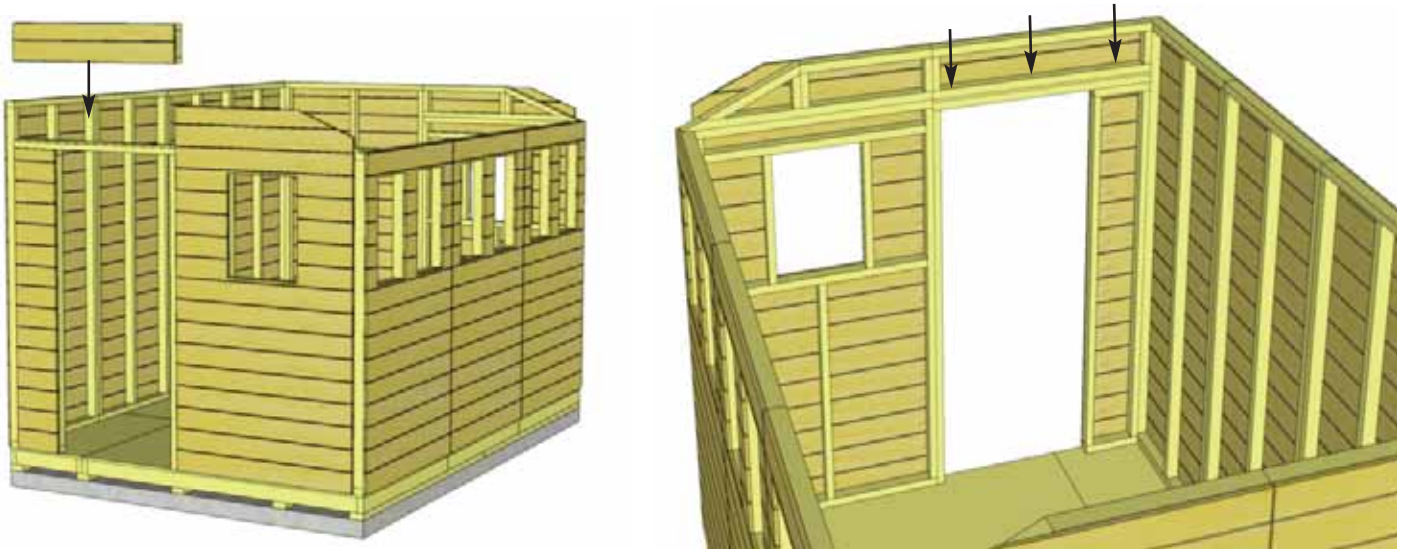

29. Locate and place **Extender Wall** on top of Door Header. Align so 2x3 framing lines up with framing of regular walls. When correctly in place, secure with 3 - 2 1/2" screws.

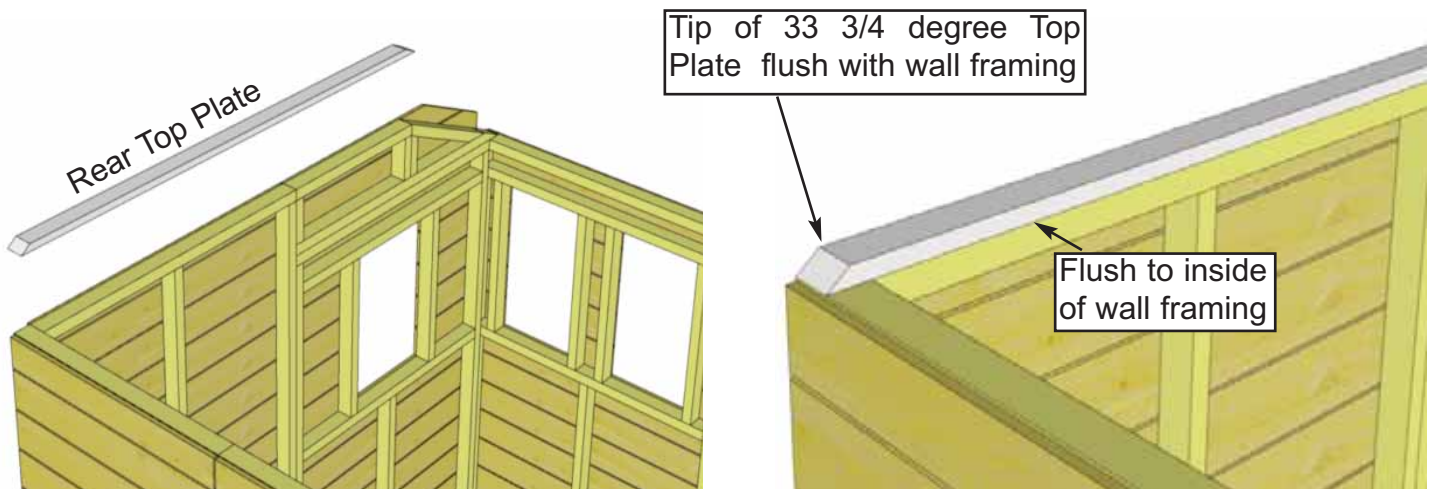

30. Locate **Rear Top Plate** (3/4" x 2 1/2" x 73 3/4") and position on wall framing flush on inside. Align so angle cut on 33 3/4 degree end is facing the high wall and 22 1/2 degree end is facing the short wall.

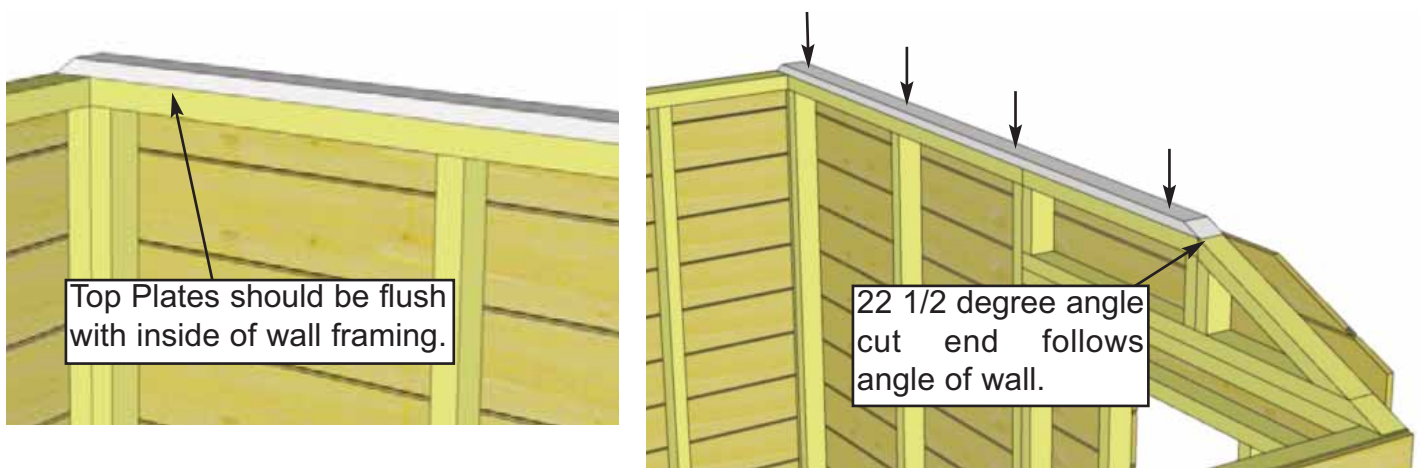

31. When properly positioned, attach by screwing down into top wall framing with 4 - 2" screws.

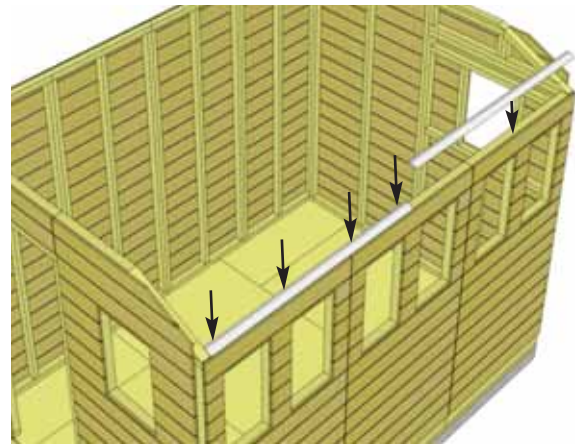
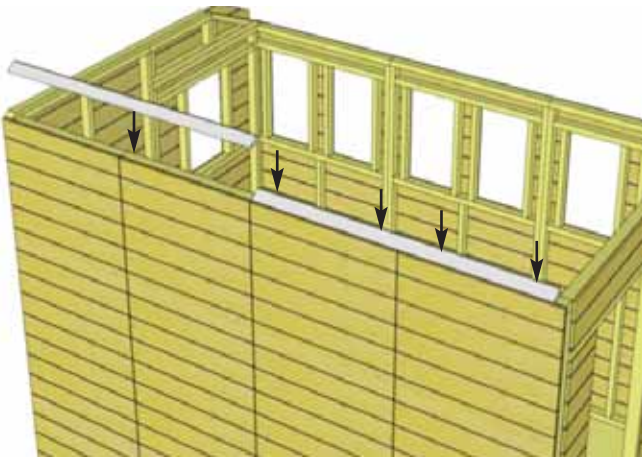

32. Next, attach the **Side Top Plates** (1 1/2" x 2 1/2" x 65 3/4" - 33 3/4 degree cut down edge) to high wall side. Once again, position top plate so it is flush with inside of wall plate. Side plate should also be flush with Rear Top Plate. Secure with 4 - 2 1/2" screws per piece. Complete Short Side Top Plates (3/4" x 2 1/2" x 65 3/4" - 22 1/2 degree cut down edge).

33. Position remaining **Front Top Plate** on wall framing and secure with 4 - 2" screws.

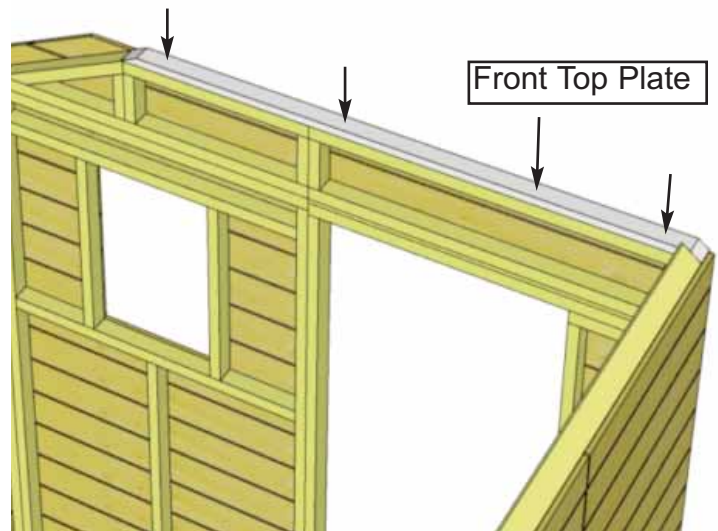

1/2" below extender wall framing.

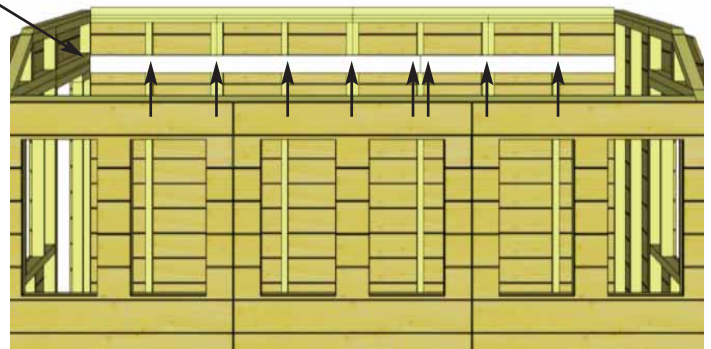
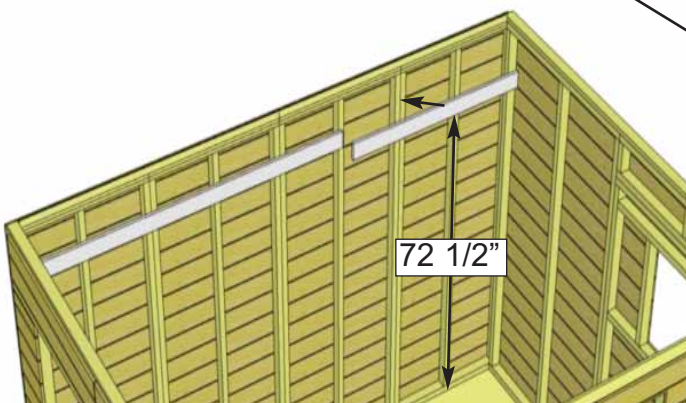

34. On the high wall side attach **Horizontal Wall Extender Braces** (3/4" x 3 1/2" x 82 3/4"/48 1/2") to wall framing to further tie walls together. Position 72 1/2" up from the floor or 1/2" below extender wall framing. Fasten each piece to wall studs as illustrated above using 8 - 1 1/4" screws.

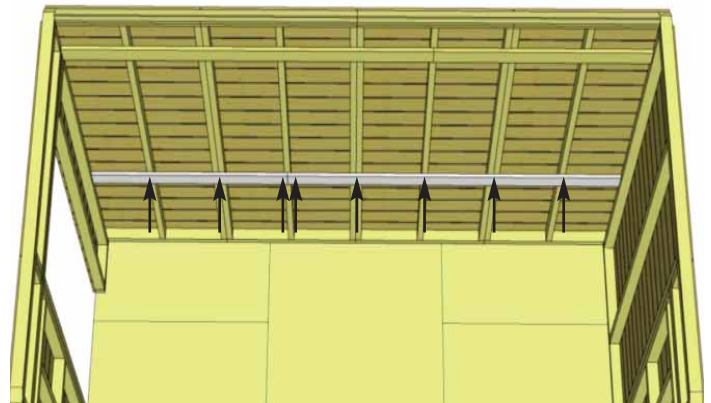
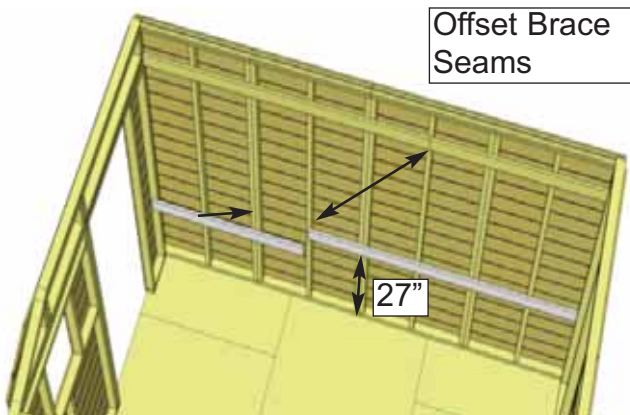

35. Repeat Step 34 but Attach **Horizontal Wall Extender Braces** (3/4" x 3 1/2" x 82 3/4"/48 1/2") to lower part of the walls approximately 27" up from the floor but offset the seams from previous braces. Attach with 8 - 1 1/4" screws.

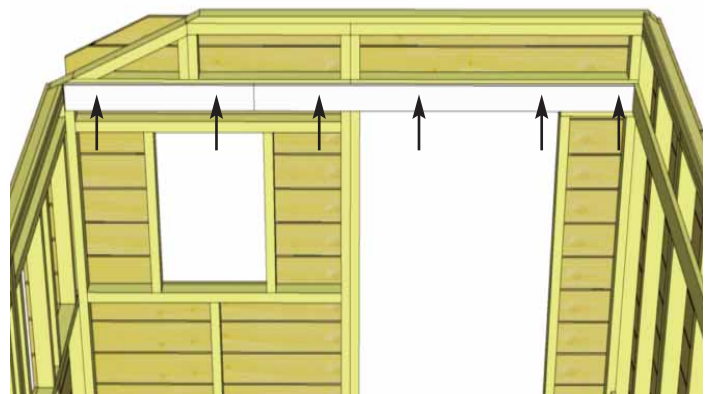
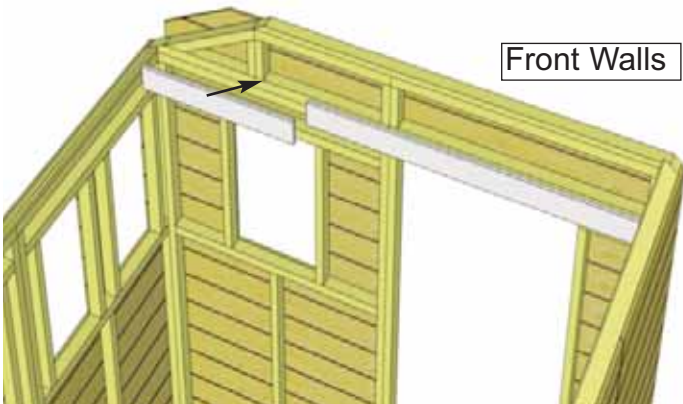

36. Attach **Horizontal Wall Extender Braces** (3/4" x 3 1/2" x 30"/60") to front and rear walls 1/2" below extender wall framing. Complete Front and Rear walls (60" and 30" long pieces) using the same alignment. Fasten with 6 - 1 1/4" screws.

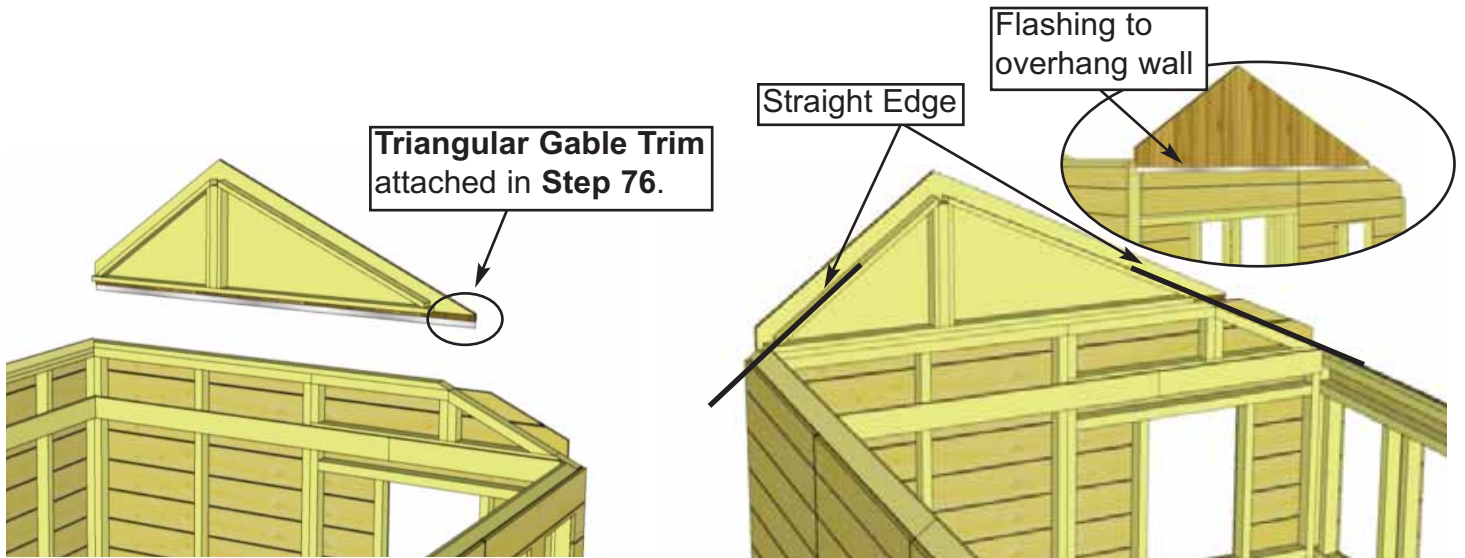

37. Lift up **Gable Wall** and place on top of rear wall. Gable side with 33 3/4" degree cut will be aligned on high wall side. Slide Gable Wall side to side and use a straight edge to line up angled framing of gable with Top Plates and Walls. There is some tolerance, try for best fit on both sides.

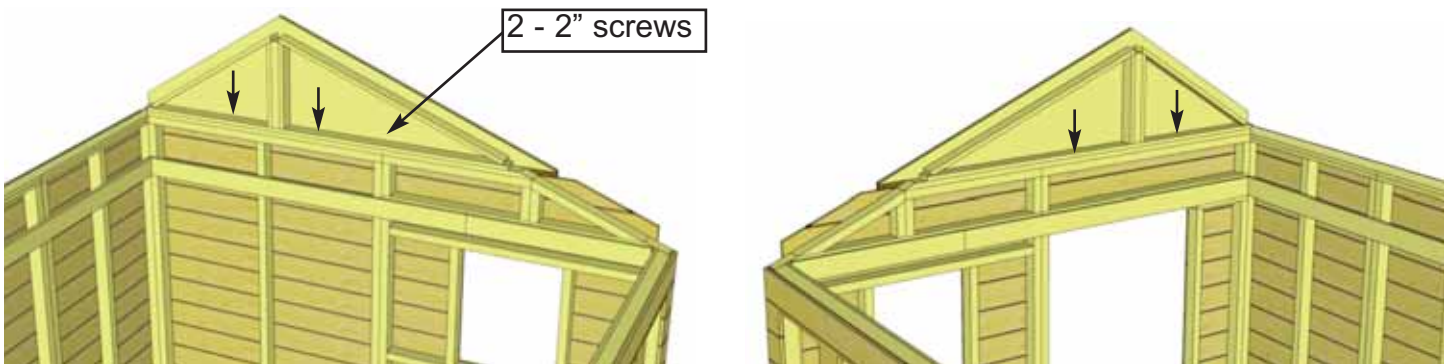

38. When Gable wall is positioned correctly, tack in place with 2 - 2" screws. Adjustment to Gable may be required in **Step 48**, where it will be further secured. Complete other Gable Wall.

C. Rafter Section

Exploded view of all parts necessary to complete Rafter and Roof Section. Identify all parts prior to starting.

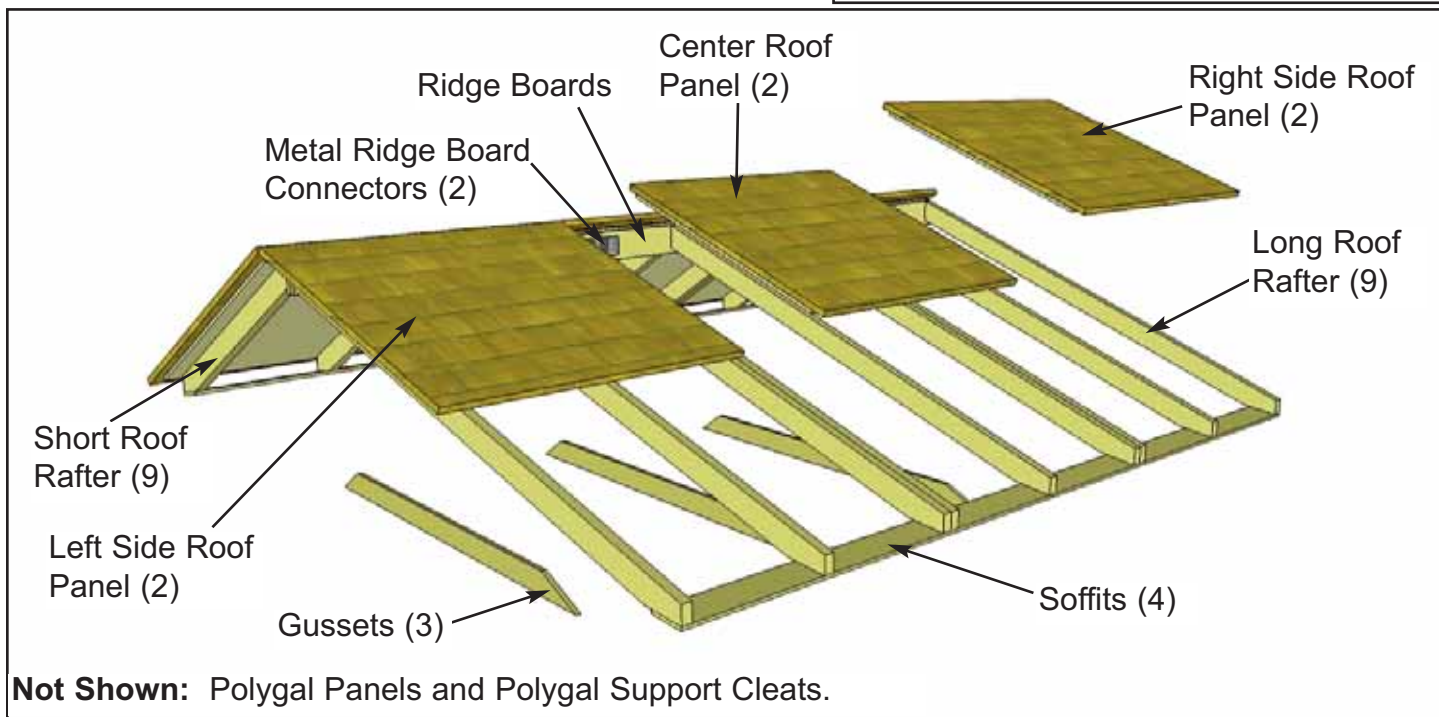

Important: Locate all parts necessary to assemble Long and Short Rafter Sections:

Long Rafter Side:
 9 - 77 3/4" long 2x4 Rafters
 1 - 3/4" x 4 5/8" x 52 1/2" - Ridge Board
 1 - 3/4" x 4 5/8" x 84" - Ridge Board
 1 - 1/16" x 3" x 7" - Metal Ridge Board Con.
 2 - 1/2" x 4 1/2" x 68 1/4" - Soffits

Short Rafter Side:
 9 - 37 3/4" long 2x4 Rafters
 1 - 3/4" x 5 1/8" x 52 1/2" - Ridge Board
 1 - 3/4" x 5 1/8" x 84" - Ridge Board
 1 - 3/16" x 2 1/2" x 7" - Metal Ridge Board Con.
 2 - 1/2" x 3 1/2" x 68 1/4" - Soffits

Follow **Steps 39 - 42** to Assemble Rafter Sections. Make sure to complete on a flat level surface. Please note the differences between the Long and Short Rafters Sides.

Long Rafter Side

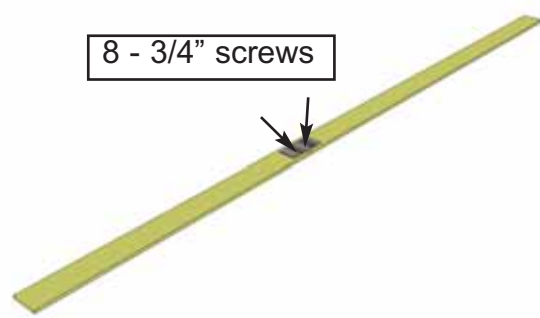
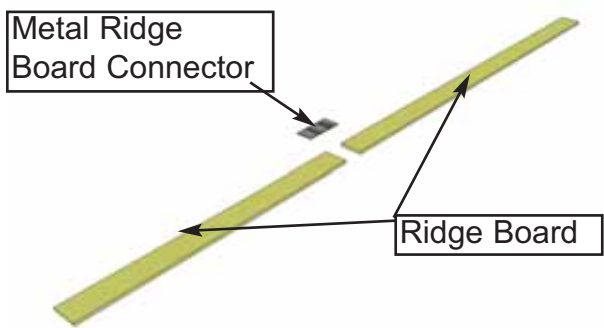

39. Locate both 3/4" x 4 5/8" x 84" & 52 1/2" **Ridge Boards (Long Rafter Side)** and attach together with **Metal Ridge Board Connector** using 8 - 3/4" screws evenly on boards. Total Length when connected is 136 1/2". Complete Short Rafter Side using same procedure only Ridge Boards are 5 1/8" wide.

40. Locate 9 **Rafters**, 2 **Soffits** and completed Ridge Board. Lay out on level ground as shown to the right. Double up Rafters as illustrated. Screw doubled up Rafters together with 3 - 2 1/2" screws per piece. **Note:** completed rafter section will be flipped over in **Step 42**.

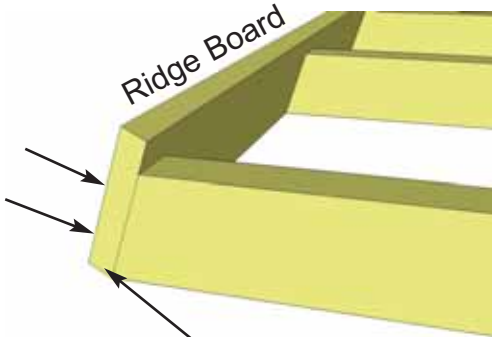
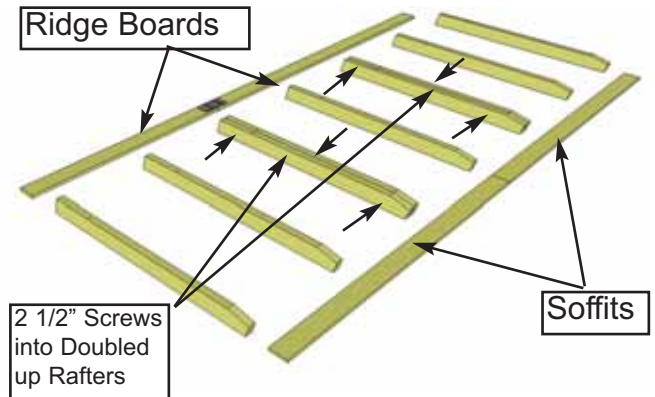

41. Attach completed Ridge Board to ends of both outside rafters with 2 - 2" screws per end. Measure and position interior Rafters as illustrated below. When positioned correctly, attach Ridge Board to remaining rafters with 2 - 2" screws /rafter end.

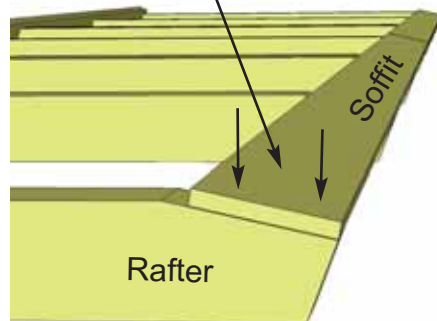
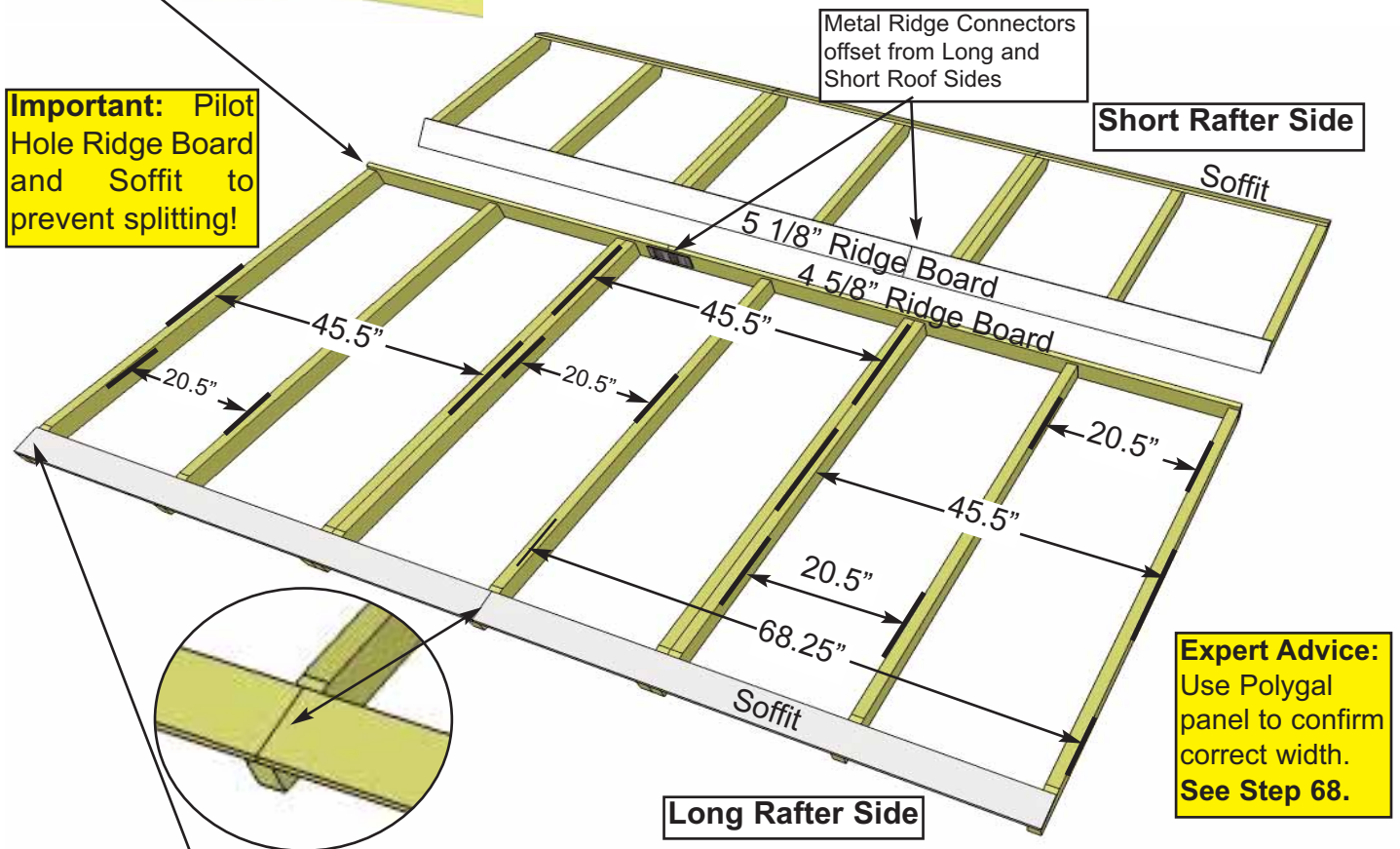

42. Attach end of a 68 1/4" long Soffit Board flush to ends of outside rafters with 2 - 1 1/4" screws per rafter end. **Drill pilot hole in Soffit ends to prevent splitting.** Complete both outside rafter / Soffit connections first. Measure and position interior Rafters as illustrated above. When positioned correctly, attach Soffits to remaining rafters with 2 - 1 1/4" screws /rafter. Flip completed rafter section over. Complete Short Rafter Side as per **Steps 40 - 42** with the following exception: **When attaching Ridge Board to Rafter ends, make sure Metal Ridge Board Connector is positioned so offset to first Rafter Section. See Step 47 for illustration.**



Slide Bottom of Ridge Board into notch of gable.

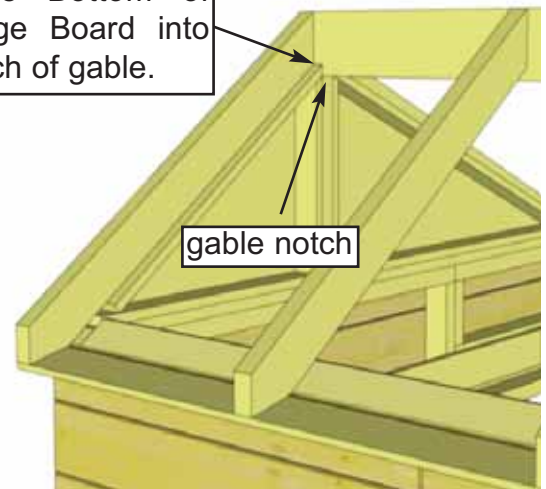

43. Starting with the Short Rafter Side, lift and flip completed section over so Soffit is facing down. Slide rafter up on gable framing until bottom of Ridge Board slips into gable notch. Position rafters so they sit evenly on Gable framing from side to side.

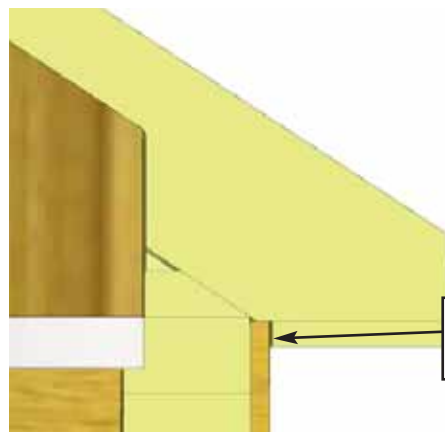

Slight gap between wall and soffit.

Important: make sure Metal Ridge Board Connectors on Long Roof Side and Short Roof side are offset. **See Step 47.**

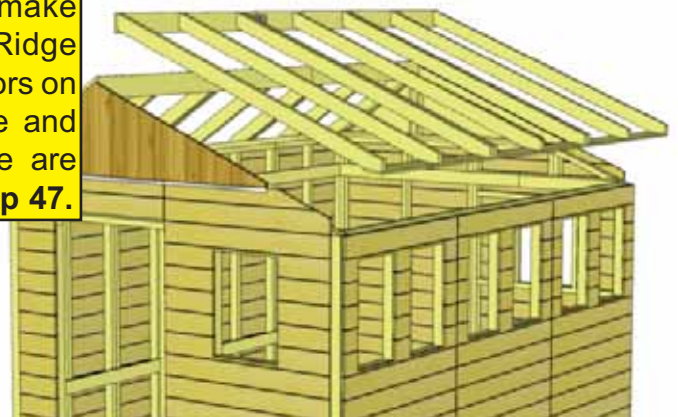

44. Where Wall and Soffit meet, a small gap may appear. Confirm all Rafters are resting on Top Plate.

45. Lift and flip Long Rafter Side up and place on Gable framing. **Make sure Metal Ridge Board Connectors of both Roof Sections are offset. See Step 47.**

Bottom of Ridge Board fits in gable notch. Top of Ridge Board will sit 1/2" lower than short rafter side ridge board.

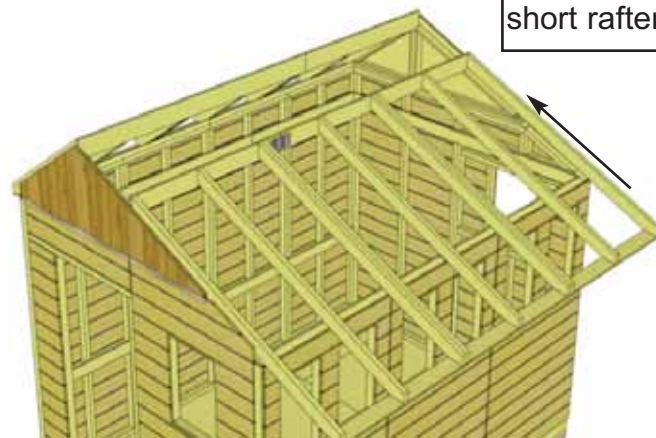

46. Slide Long Rafter Side on Gable framing so bottom of ridge board slips into Gable notch. Soffit will sit approximately 1/8" away from wall as per **Step 44.**

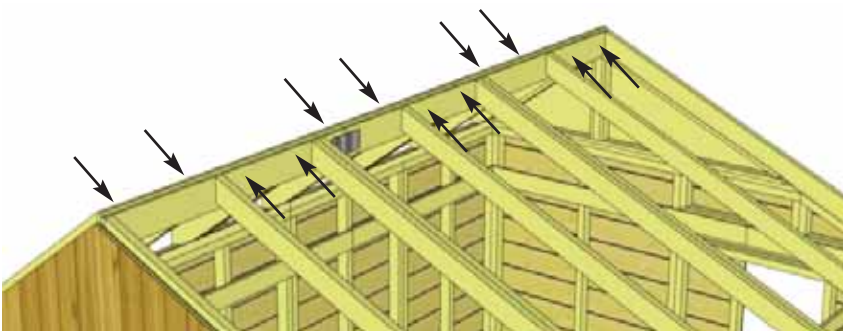

Offsetting Metal Ridge Board Connectors.

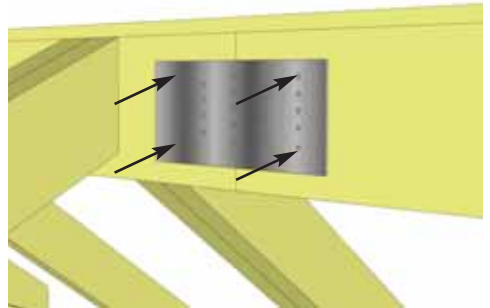
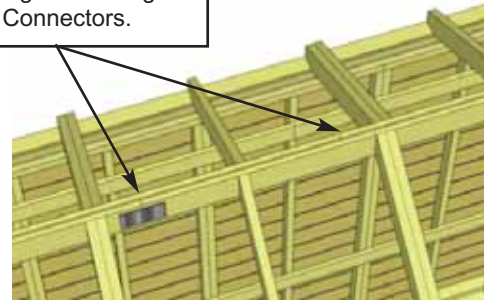

47. Where Ridge Boards meet, press together and secure with 12 - 1 1/4" screws. In addition, place 4 - 1 1/4" screws into any of the remaining Metal Ridge Board Connectors holes. Complete both sides.

Important: If Gable framing does not line up with Rafters, remove temporary 2" screws from gable framing (Step 38), re-align gable and proceed to step 48.

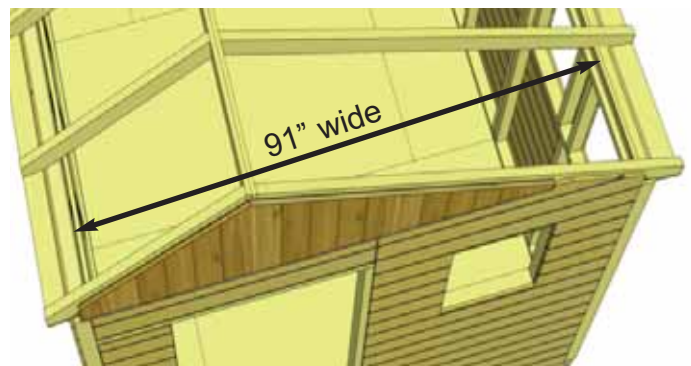
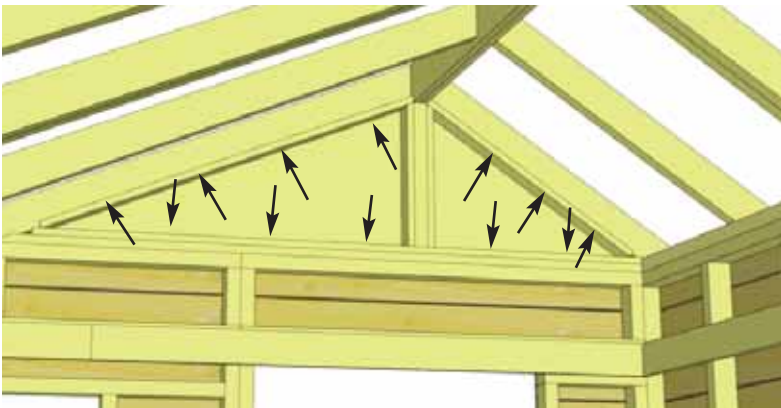

48. When aligned, secure Gable framing to rafters with 7 - 2" screws. Further secure to top plate with an additional 5 - 2" screws (7 in total). Secure other Gable.

49. Prior to securing the Long Rafter Side, make sure walls are aligned correctly. Have two helpers push on both side walls at the top from the outside until side top plates are 91" apart from the **inside**.

Rafter Brackets are bent to 22° and 33°. Use correct bracket for each side.

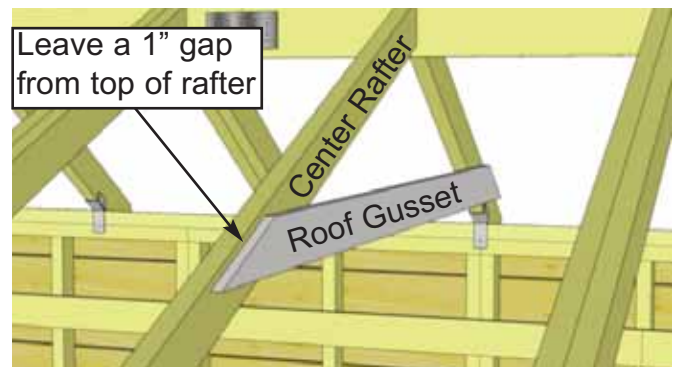
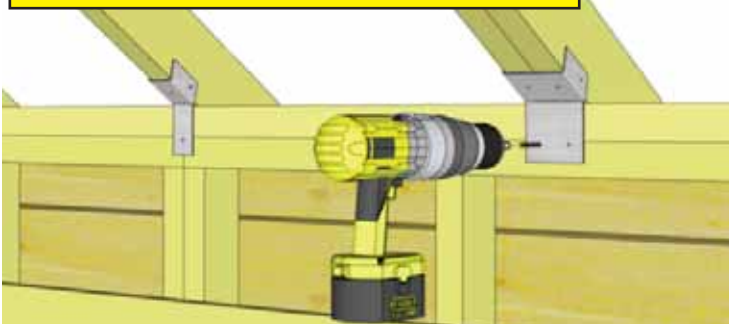

50. Attach all **Single** and **Double Rafter Brackets** where rafters meet Top Wall Plates inside of shed. Attach with 2 - 1 1/4" screws and 2 - 2" screws per Single Rafter Bracket and 6 - 2" screws per Double Rafter Bracket. Position a Roof Gusset on the Center Rafter. Leave a 1" gap from the top side of the rafter.

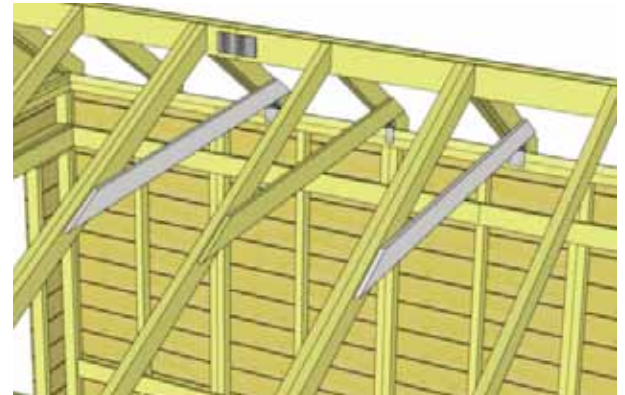

51. With Gusset correctly positioned, attach to Rafter with 4 - 2" screws per side. Use a level to check for square. Pilot hole end of Gussets to prevent splitting. Complete installation of remaining Gussets.

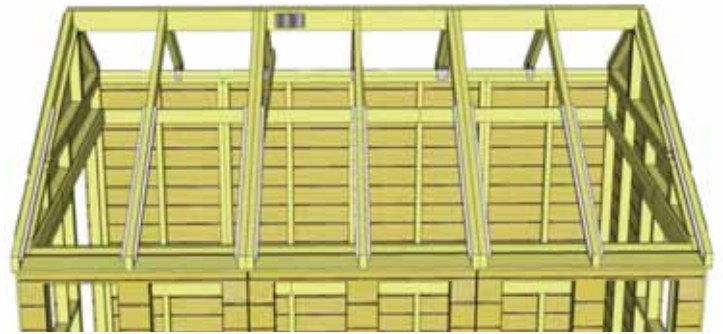
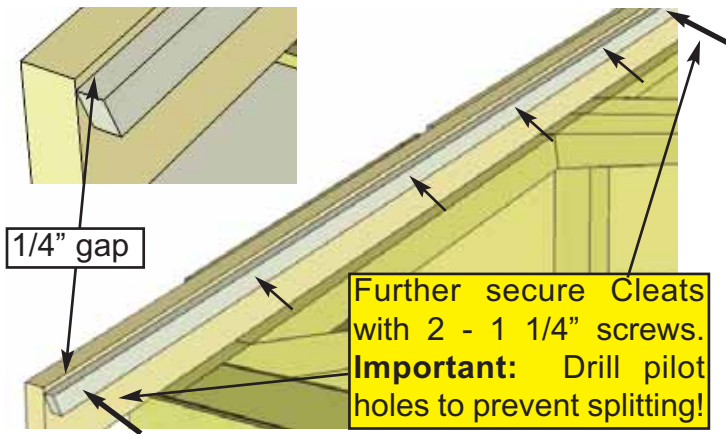

52. Position 3/4" x 3/4" x 44 1/2" long **Polygal Support Cleats** on each Long Rafter flush to end and recessed 1/4" down from top of rafter. Pilot hole 1/8" in both ends and attach with 1 1/4" screws. Nail also to rafter using 4 - 1 1/2" finishing nails. **Note:** Start nails in Supports on ground first. Complete remaining 11 Polygal Support Cleats.

D. Roof Section

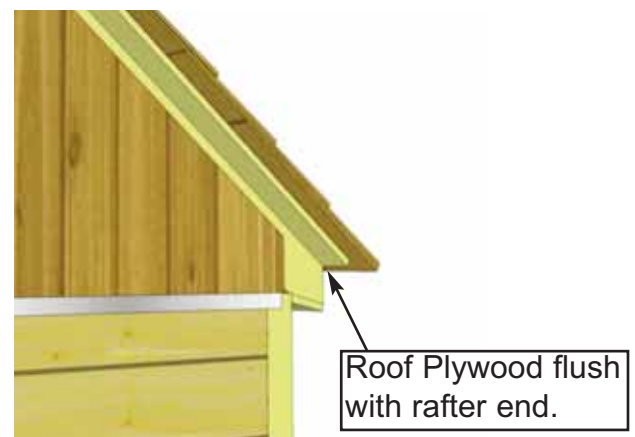
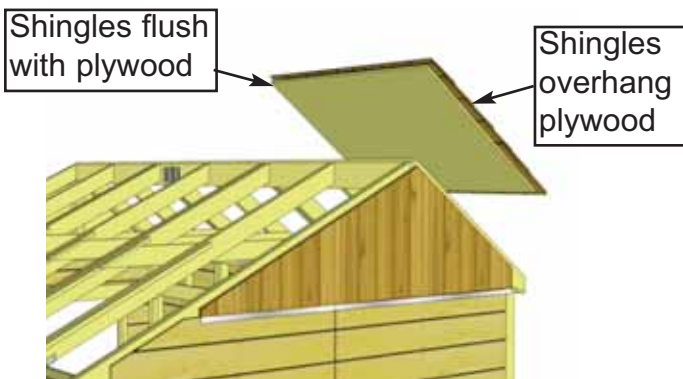

53. Identify all **Roof Panels**. There are 2 Outside Right, 2 Center and 2 Outside Left Roof Panels. The outside of the panels will have shingles overhanging the plywood. Starting with an Outside Roof Panel on Short Rafter Side, lift up and place on rafters so centered on mid rafter. Plywood on roof should be flush with end of rafter at bottom.

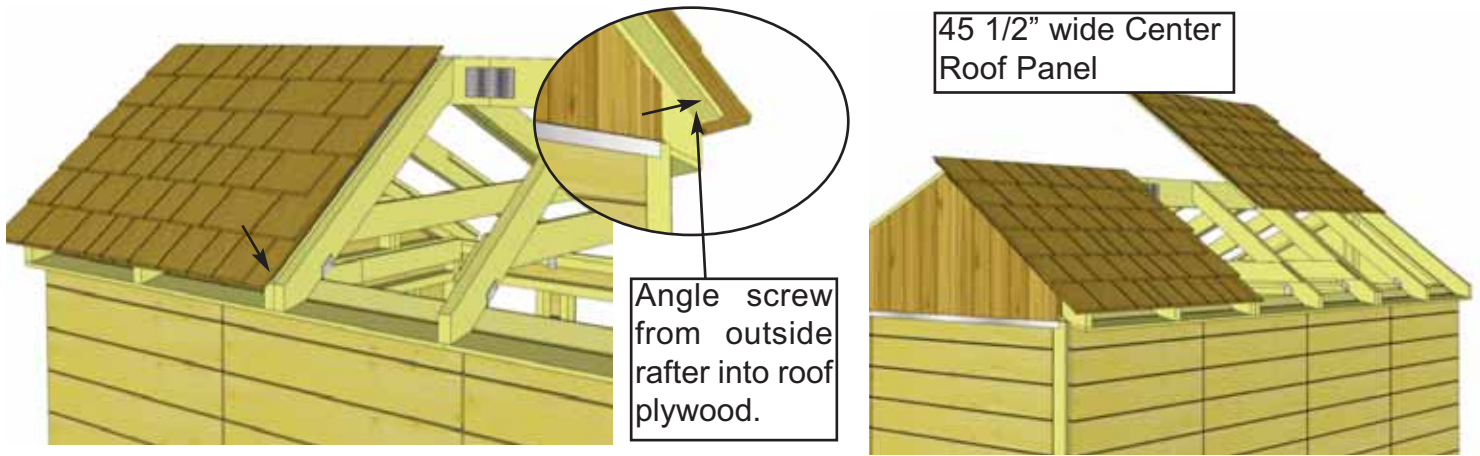

54. Place Roof Panel so it sits flush on 3rd rafter from the outside (doubled up rafter). Plywood on roof should be flush with end of rafter at bottom. From the outside, screw down through bottom row of shingles into rafter with 1 - 2 1/2" screw. Additionally, angle a 2 1/2" screw from outside rafter into roof plywood. Position Center Roof Panel on both doubled up rafters.

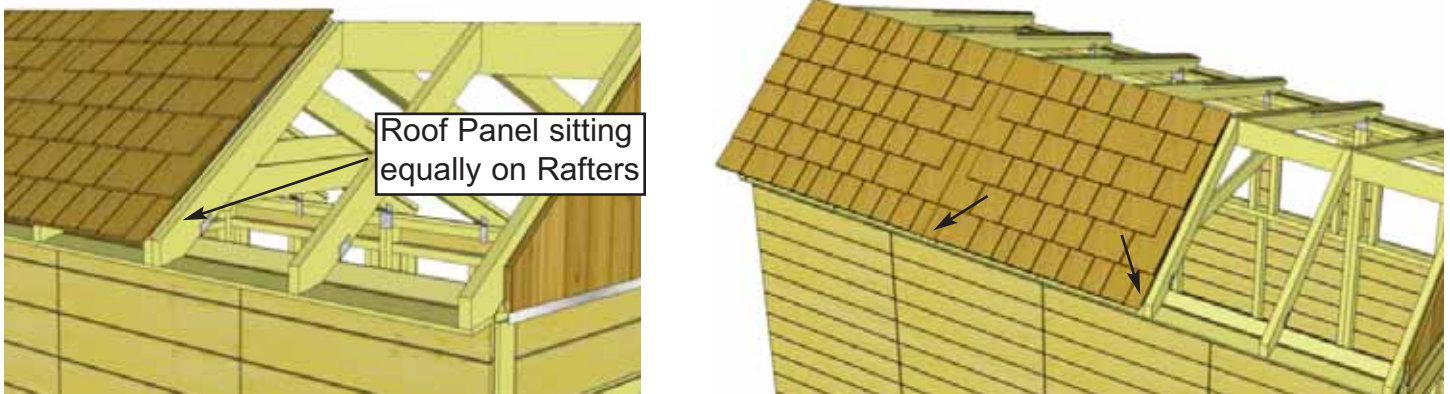

55. Position Center Roof Panel with plywood flush with bottom end of rafter as per **Step 54**. From side to side, make sure Roof Panel is sitting equally on rafters. When positioned correctly, screw down through bottom row of shingles into rafter with 2 - 2 1/2" screws.



56. Lift up and place an Outside Roof Panel on rafters. Again, plywood on roof should be flush with end of rafter at bottom.



57. When positioned correctly on rafters, secure as per **Step 54**. Lift and Place 1st Outside Roof Panel for Long Rafter Side.

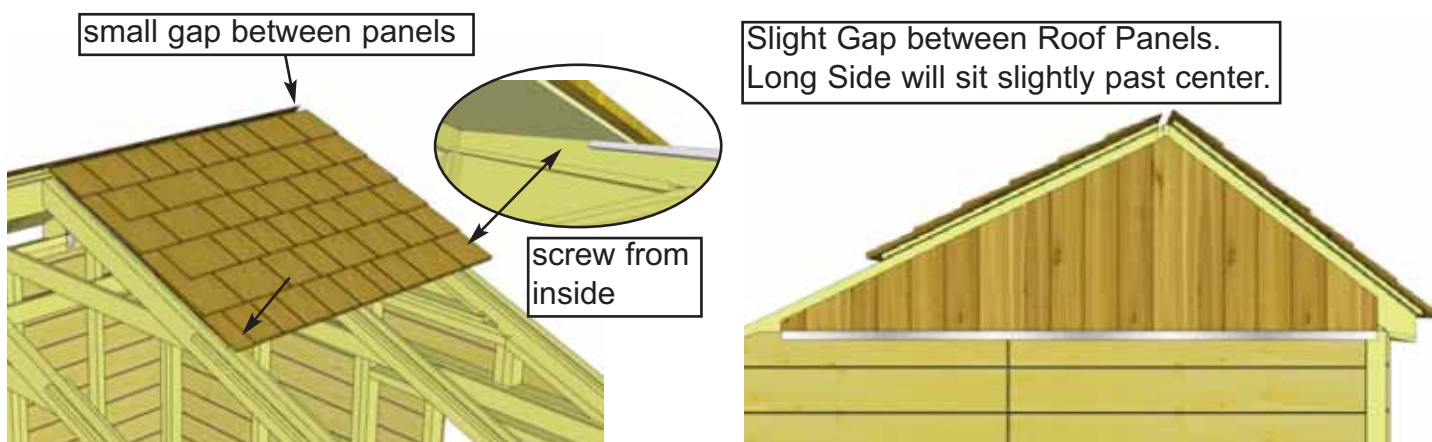

58. Position Outside Roof Panel equally on rafters. Align Roof Panels at top so only a small gap between panels exists. When positioned correctly, screw down with 1 - 2 1/2" screw in bottom row of shingles. Additionally, from inside, angle a 2 1/2" screw from the roof rafter into the roof plywood to secure.



59. Follow **Steps 53 - 58** for positioning and attaching Long Rafter Roof Panels. Work from inside the Sunshed when completing the Roof Panels.

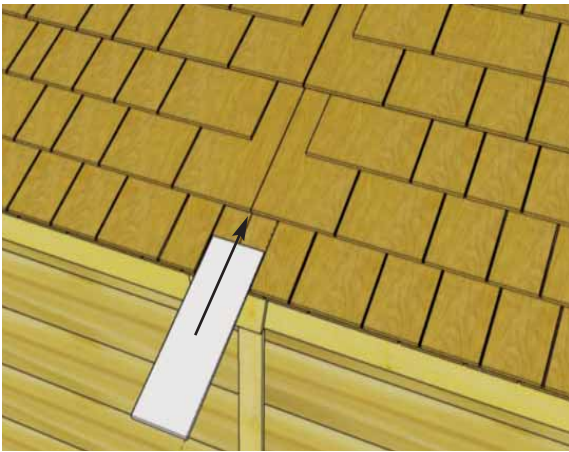

60. Next, install **Filler Shingles** to hide roof seams of shed. Starting at bottom on Short Roof Side, push a Long Filler Shingle underneath shingles directly above it until end is flush with bottom shingles.

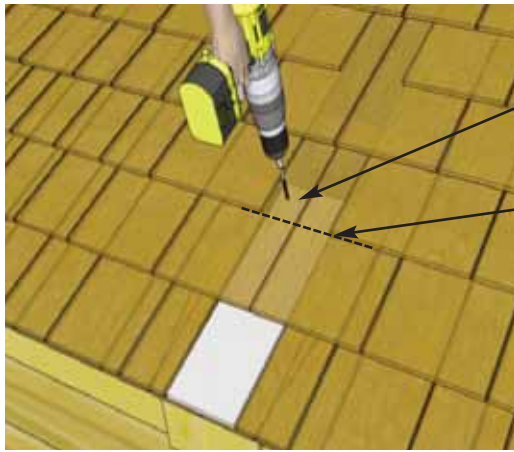

Attach above the exposure line.
Exposure Line

61. Screw first filler shingle down to rafters above the exposure line, using 1 - 2 1/2" screw per panel (2 in total). Make sure to screw into both rafters.

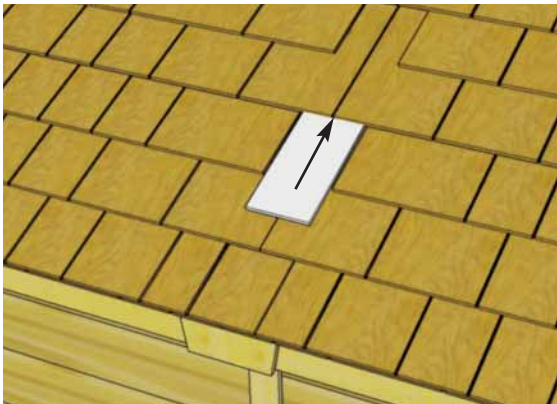

62. Slide in the next Long Filler shingle and attach as per **Step 61**. At the top, use smaller shingles to fit. Attach final shingle to roof with 2 shingle nails. Complete Long Roof Side next. There are 2 - Long shingles and 1 Short shingle per roof seam.

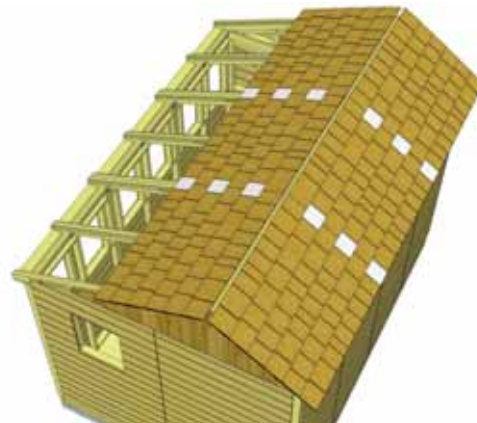

63. Position Simpson Strong ties on plywood and outside rafters and secure with 4 - 1 1/4" screws. There are 4 ties per gable.

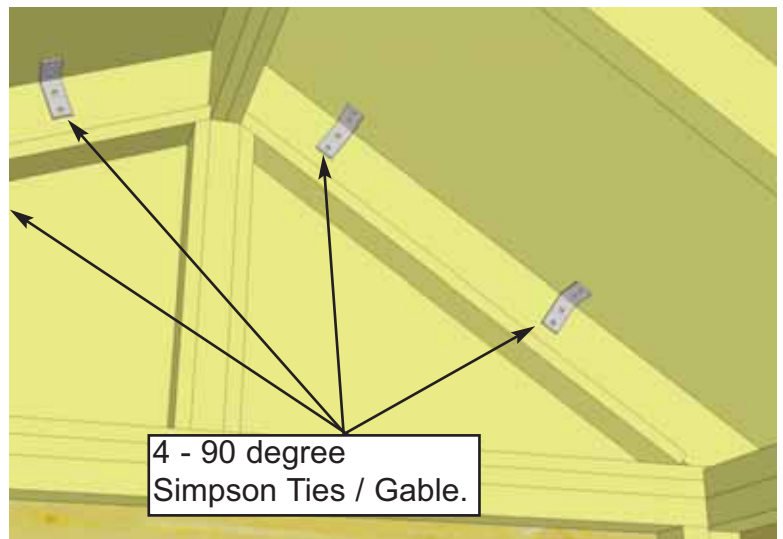

4 - 90 degree Simpson Ties / Gable.

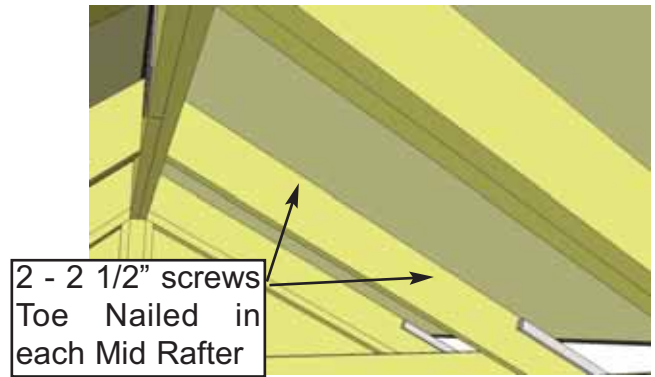
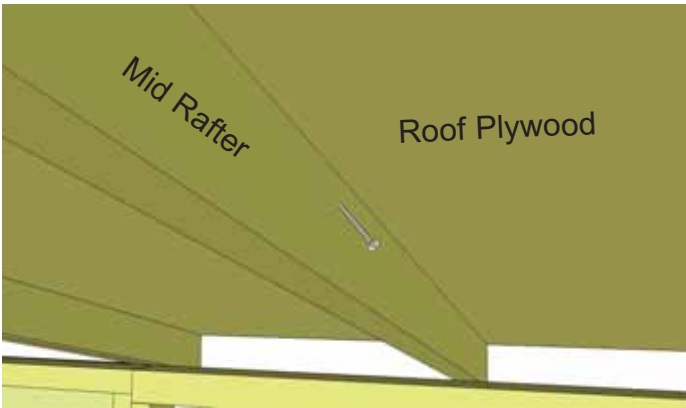

65. To further secure roof panels, from the inside, drill pilot holes in each Mid Rafter (2 per Rafter) on an angle. Using 2 - 2 1/2" screws, secure rafters to roof plywood. **Note:** from outside, have a helper push roof panel down so plywood sits flush against rafter when securing.

Alternate Ridge Cap seams (offsetting angle cut at peak)

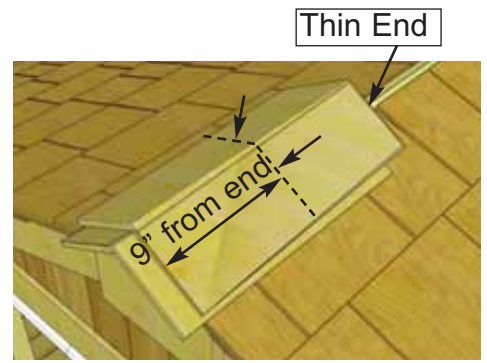
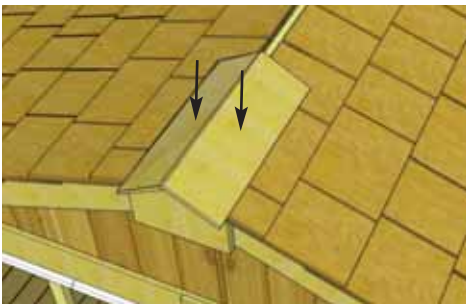

66. Place First **Roof Ridge Cap** on roof peak overhanging shingles by approximately 1". Attach with 2 - 1 1/2" Shingle Nails 9" from end. Place 2nd Ridge Cap 1" back from 1st cap. Attach with 2 - 1 1/2" Shingle Nails 9" from end. Alternate each Ridge Cap seam as you proceed

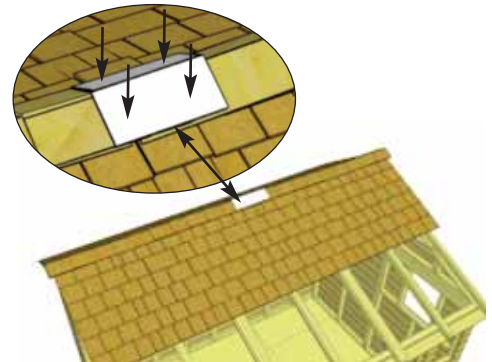
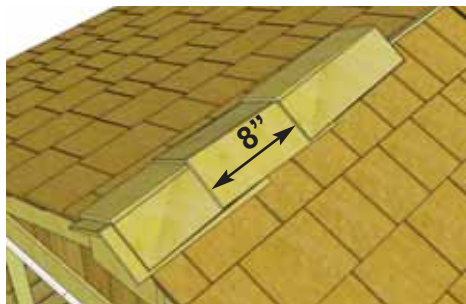
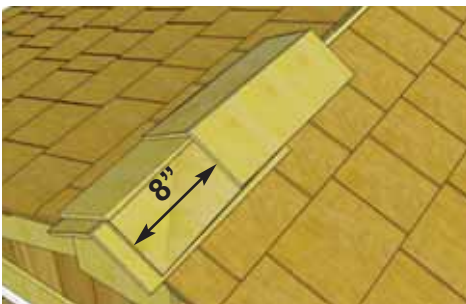

67. Place 3rd Ridge Cap 8" back from 2nd (enough to cover shingle nails). Attach 3rd Ridge Cap down as per **Step 66**. Continue to position and attach Ridge Caps until half the roof is complete. From opposite side, position and attach Ridge Caps as described above. Score/cut 1 Ridge Cap to 12" or to fit in the center of roof. Attach center cap with 4 - 1 1/2" Shingle Nails.

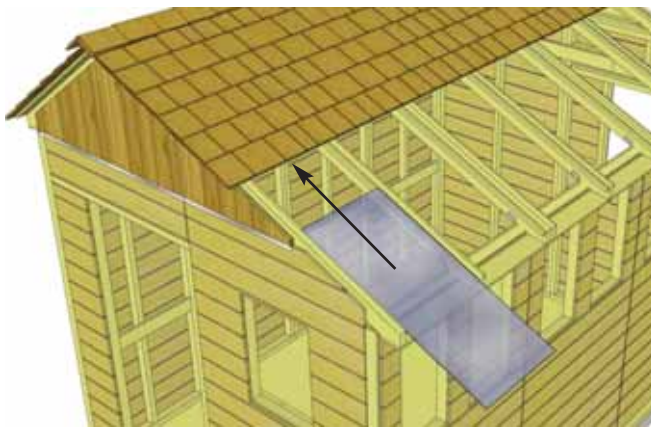

68. Installation of **6 Polygal Panels** is next. Start by removing protective plastic layer on each panel. Exterior/interior side of protective polygal film is printed on film, be sure to note the side and install accordingly. Slide 1st panel up between rafters so it rests on Polygal Support Cleats.



69. From the inside, carefully slide end of panel underneath roof. Position Polygal Panel with equal gaps between rafters, and overhanging end of rafters by 1". With 6 - 1" screws, secure panel to Polygal Support Cleats.

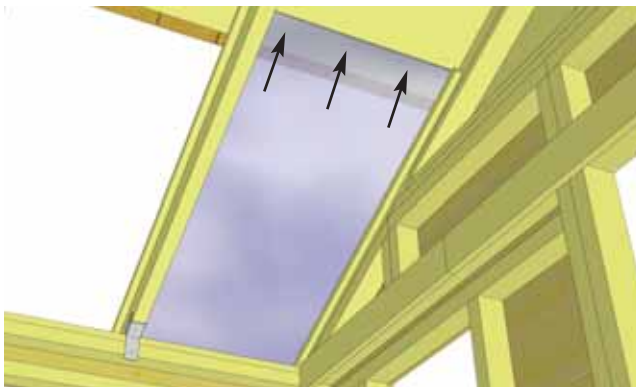

70. Use 3 - 1 1/2" finishing nails to secure Polygal Panel to underside of roof plywood.

71. Position and secure 2nd Polygal Panel as per **Steps 68-70**.

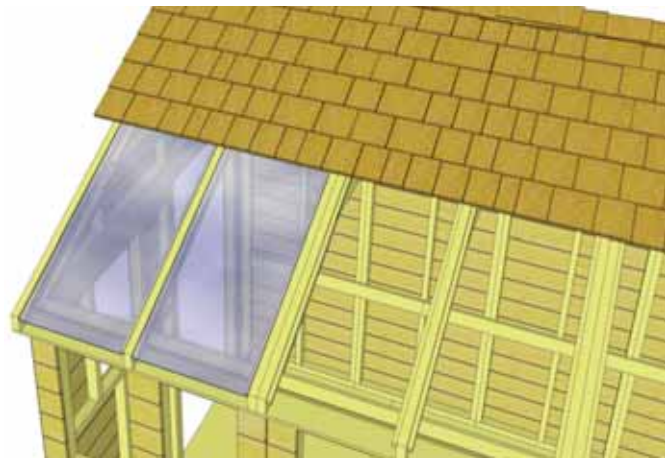

72. Complete installation of remaining Polygal Panels.

73. With a Caulking Gun, apply **Silicon** to seal gaps between rafters and Polygal Panels. Apply Silicon down each side of rafter. Use liberal amounts to properly seal the gaps.



E. Miscellaneous Section

Expert Advice: When installing trim, sort pieces according to color and pieces that are most pleasing to the eye. Start with least visible side and use the least desirable pieces first. Install trim to most visible sides as your skill installing trim improves.

74. Attach **Bottom Skirting** around the base of the shed. Skirting will hide floor framing. Start with left side pieces first and attach with 4 - 1 1/2" finishing nails per piece. Left side has 4 pcs at (1/2" x 4 1/2" x 34 1/8"). Right side has 3 pcs at (1/2" x 4 1/2" x 45 1/4"). Front and Rear each have 2 pcs at (1/2" x 4 1/2" x 45 1/4"). Gaps on outside of the front and rear walls will be covered by Wide Trim pieces later. Attach each piece with 4 - 1 1/2" finishing nails.

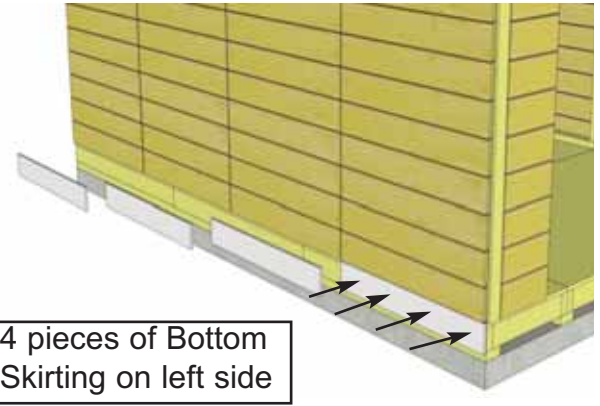

Gap in corner

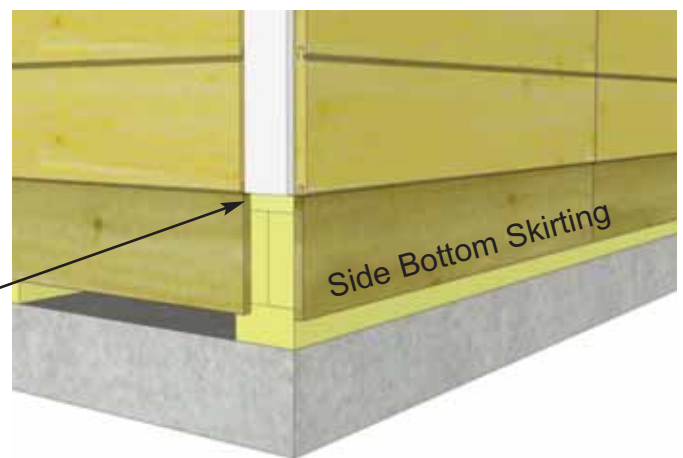

75. Attach **Filler Trim - Tall and Short** (2 @ 5/8" x 2 1/2" x 75" & 2 @ 84") to front and rear walls in each corner. Attach with 6 - 1 1/2" finishing nails. Strips are positioned flush with siding and bottom skirting.

76. Align and attach both **Narrow and Wide Trims** in each corner. Starting with a Narrow Trim (1/2" x 2 1/2" x (2 Short Wall @ 79") & (2 Tall Wall @ 88")), align tight underneath Soffit and Rafter. Position flush with Filler Trim so Wide Trim will cap it when attached in **Step 77**. Use 8 - 1 1/2" finishing nails to secure. Note that Narrow Trim will sit slightly below Bottom Skirting when correctly attached.

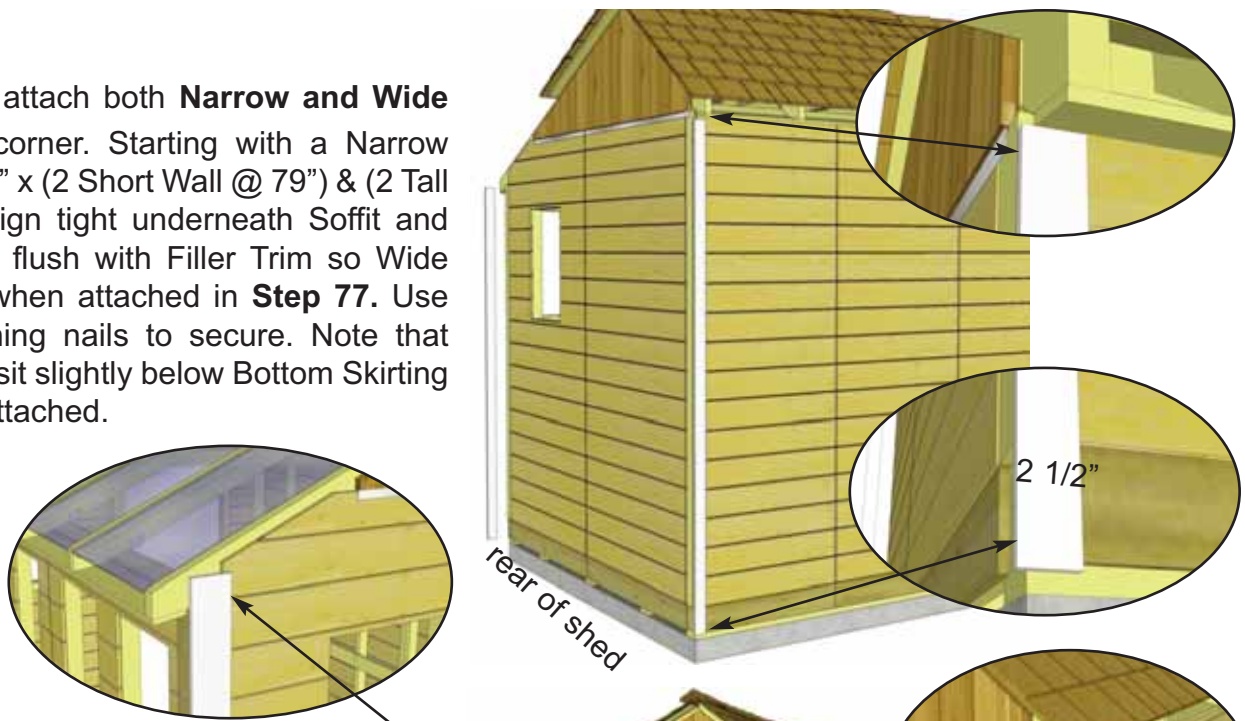

77. Position **Wide Trim** (1/2" x 4 1/2" x (2 Short Wall @ 82") & (2 Tall Wall @ 87")) over Filler Trim and to cap Narrow Trim. Align Wide Trim at bottom with Narrow Trim so flush with each other. Secure trim with 8 - 1 1/2" finishing nails. Complete remaining corner trims.



Same vertical height as Wide Corner Trim.

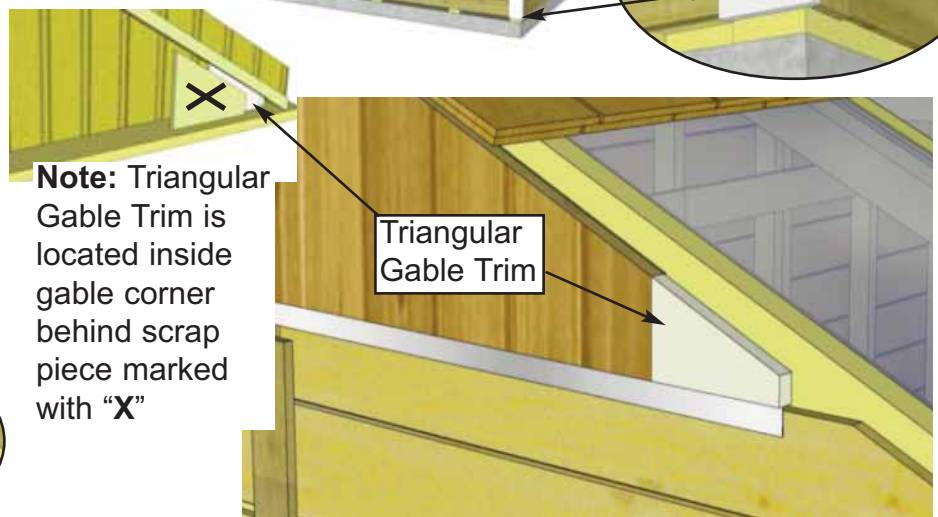
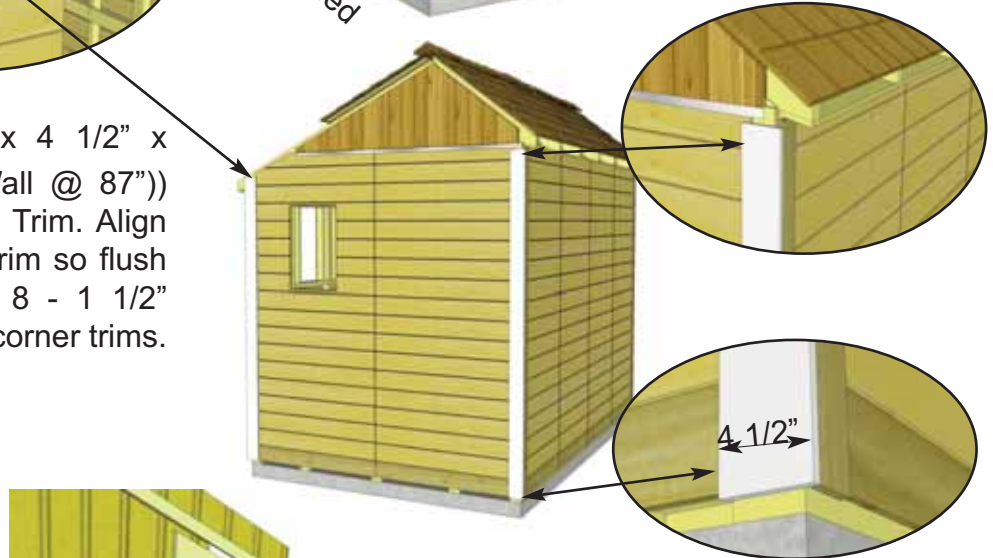

Note: Triangular Gable Trim is located inside gable corner behind scrap piece marked with "X"

78. Position **2 Door Trims** (2 @ 1/2" x 2 1/2" x 87") on each side of door opening. Right side will sit flush with Door Jamb. Left side will sit flush on edge of Narrow wall. Attach with 8 - 1 1/2" finishing nails. Do a dry run with the **Horizontal Gable Trim** (**Step 94 & 95**) to confirm vertical location of Trims. Next, position **Triangular Gable Trim** over exposed cavity of Gable Wall on Long Roof Side. Use 2 finishing nails to secure into rafter. Complete for both front and rear Gables. **Important** - Gable Trim will be found stapled in the corners on inside of gables.



79. Attach remaining **Narrow Wall Trims** where wall panels come together and leave a seam.
Note: the Narrow Trim is 79" long on the Short Wall Side, 88" long on the Tall Wall Side, and 87" on the Rear Wall. Align Side Trims tight underneath Soffit and Rafter. Attach with 8 - 1 1/2" finishing nails per piece. Align and attach Rear Trim as per Door Trims in **Step 78**.

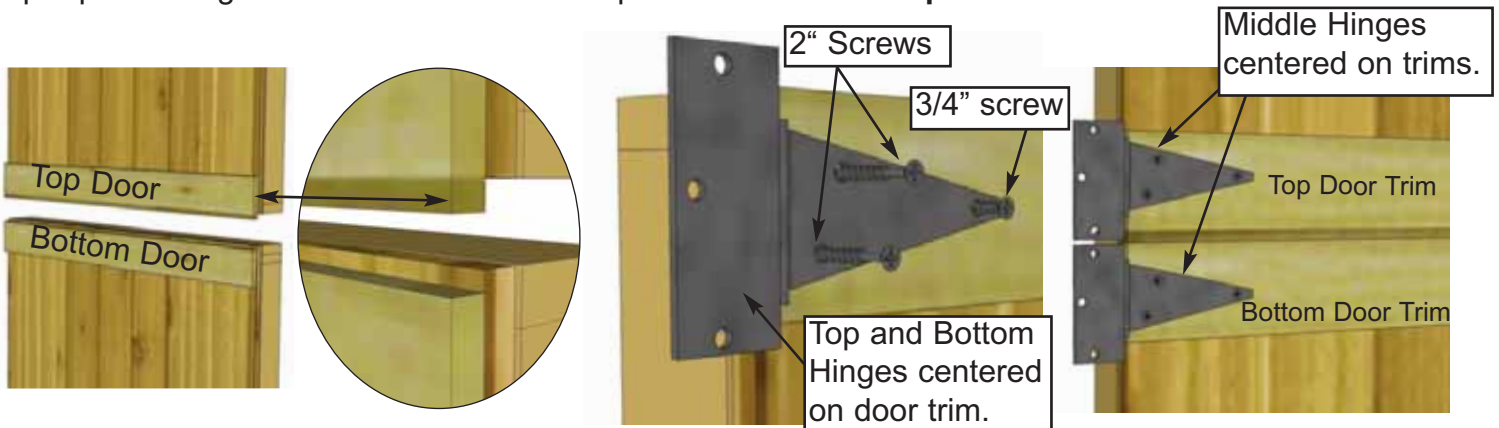

80. Attach Door Hinges to **Top** and **Bottom Dutch Door** sections. Top Door has trim overhanging door at bottom while bottom door has trim recessed slightly. Hinges should be centered on door trim with barrel nudged to end of trim. Use 2" & 3/4" black headed screws as shown above.

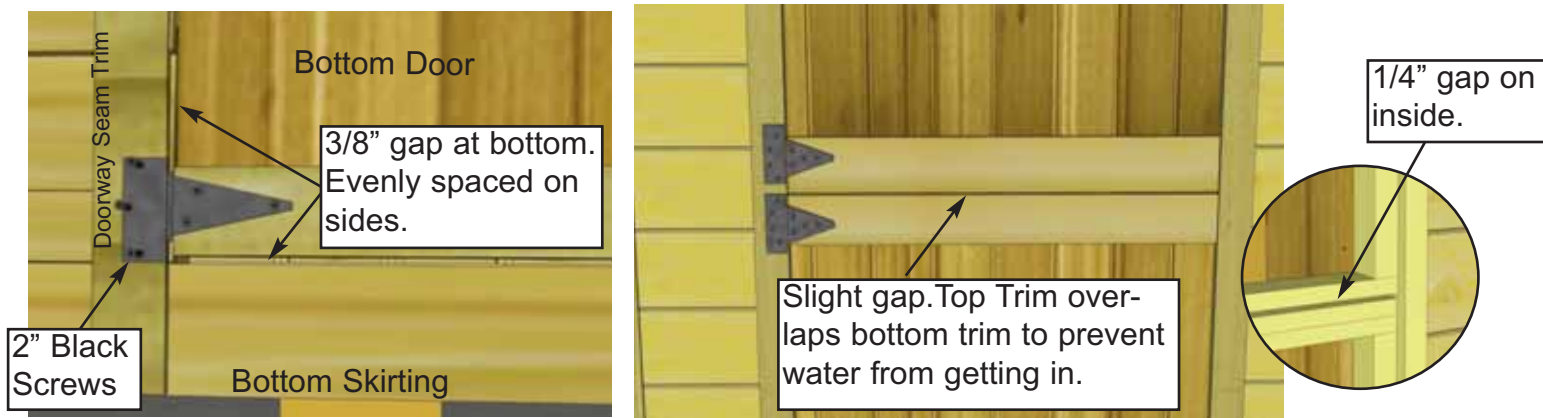

81. Place Bottom Dutch Door panel into position. Gap 3/8" on bottom, evenly space on sides, and attach hinge to doorway seam trim with 2" black headed screws. Use shim to help keep the door evenly spaced on bottom. One of the extra roof shingles (see parts list) can be used.

82. Place the Top Dutch Door Panel into place and gap top and bottom trims on the outside about 1/8" apart. On the inside, horizontal door frames should be about 1/4" apart. Use a shim once again to help you. Attach hinges to trim with 2" black headed screws provided.

Important: Drill pilot holes with 1/8" drill bit prior to securing with screws to prevent wood splitting. On 3/4" screw, drill shallow pilot hole only.

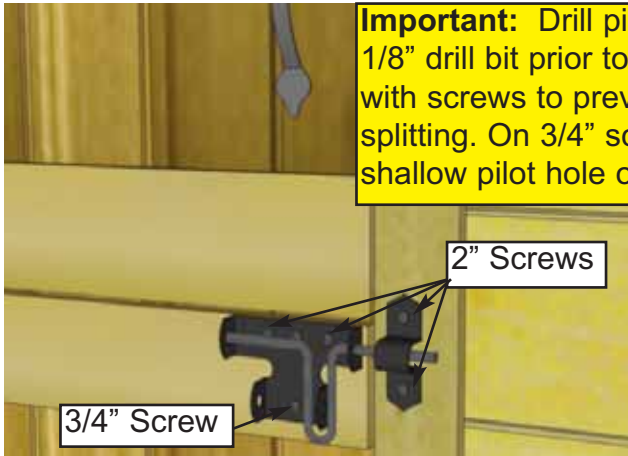

Temporarily positioned Interior Vertical Door Stop to help align Interior Barrel Bolt.

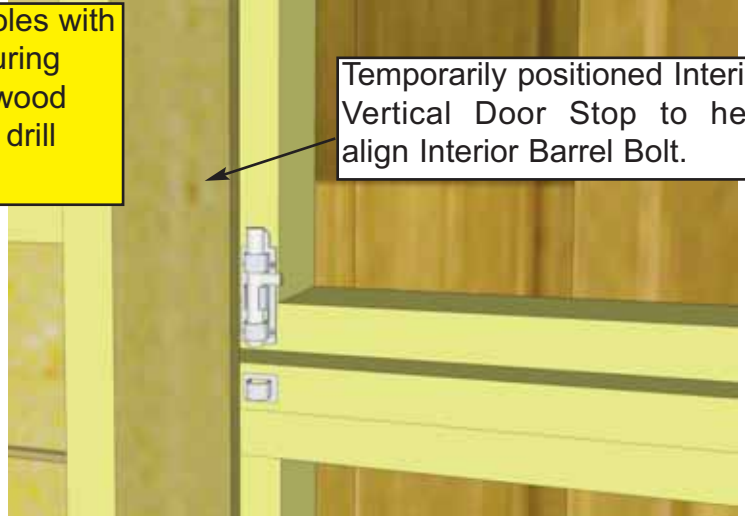

83. Attach **Door Handle and Exterior Black Drop Latch** to door. Handle is positioned on top door, Drop Latch on bottom door. Attach Black Drop Latch as illustrated above with 2" & 3/4" Black Screws. Note how female part of Drop Latch is positioned higher than male. Do a dry run first to position Drop Latch correctly.

84. Attach **Interior Silver Barrel Bolt** to inside of door as illustrated above. Use 3/4" silver screws to secure. Refer to **Step 96** to allow for adequate clearance.

Ridge Cap slides under Roof Panel and has nailing strip attached to outside underside of it. Strips allows fascia to attach easier in **Step 87**.

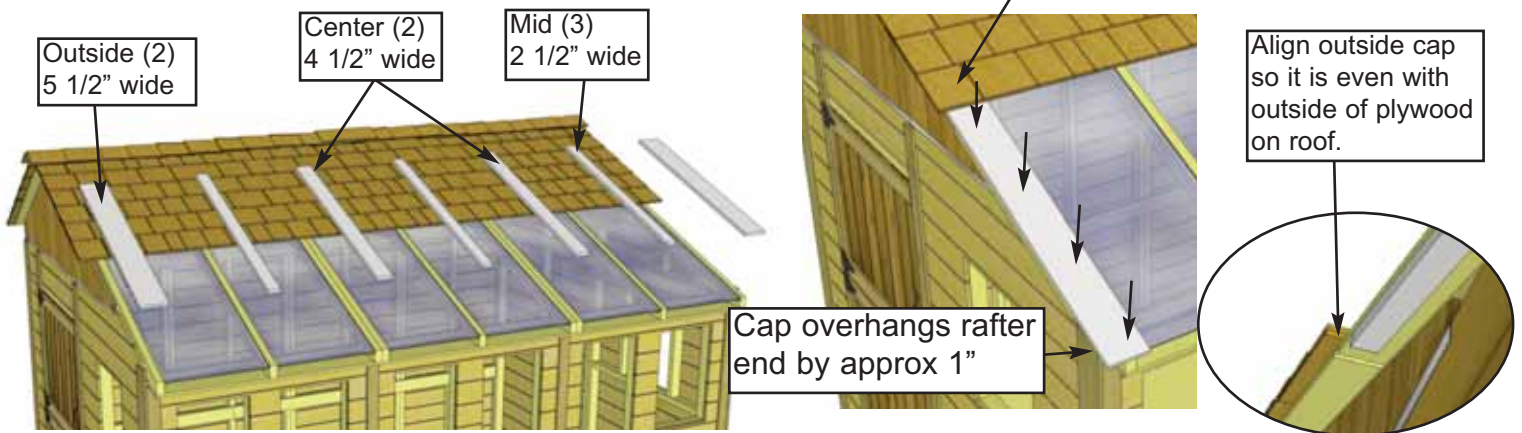

85. Locate all **Ridge Caps** for Polygal Panels (3 Mid / 2 Outside / 2 Center). Starting from the outside, position both 5 1/2" wide caps so outside edge is aligned with edge of roof plywood and Cap end slides under roof. Use a straight edge to aid in alignment. **See below.** When correctly aligned, attach Caps to center of outside rafter with 6 - 1 1/2" finishing nails. Ridge Cap has nailing strip attached.

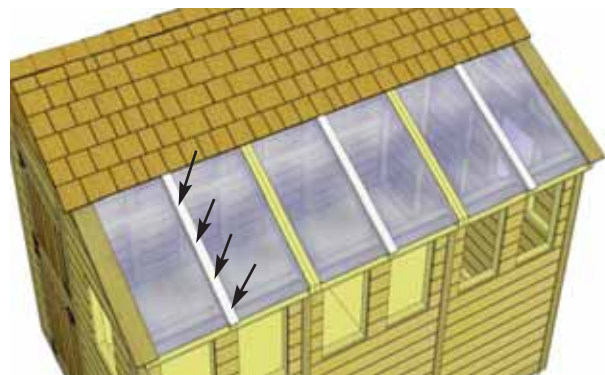
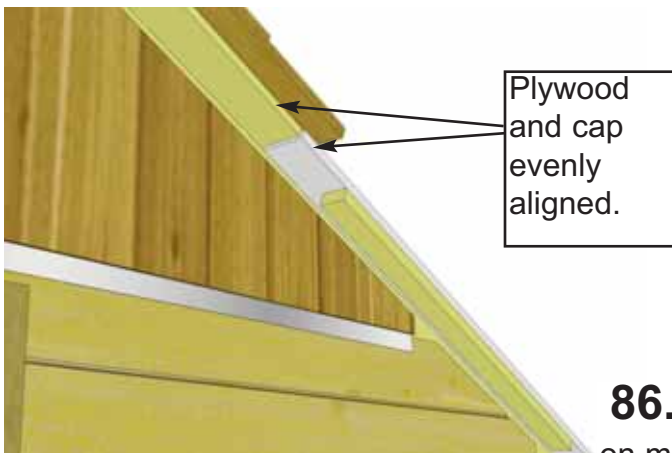

86. Position and attach Mid Ridge Caps evenly spaced on mid rafters. Align top to bottom as per **Step 85**.

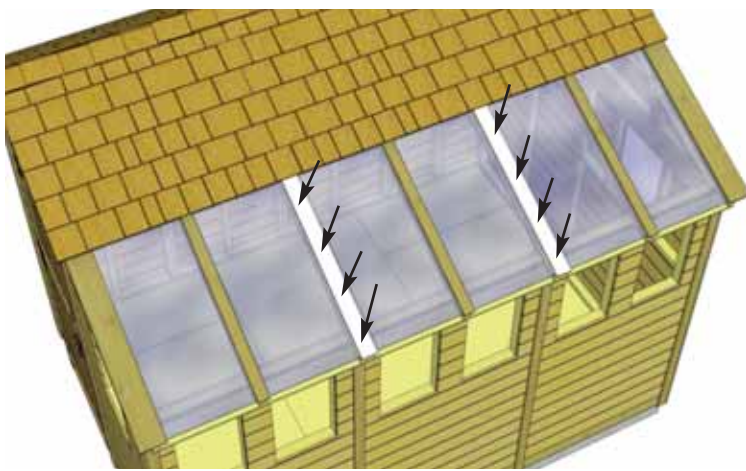

87. Align and attach remaining Ridge Caps (4 1/2" wide) over Double Rafters as per **Steps 85 & 86.**

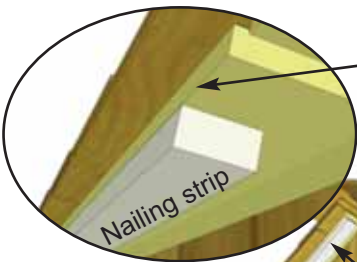

Edge of plywood roof.

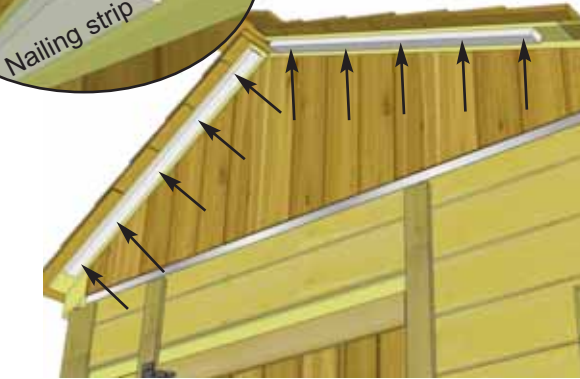

88. Attach **Facia Nailing Strips** (3/4" x 1 1/2" x 34") to the outside of plywood roof sheathing using 3- 1 1/4" screws per piece. Do all outside roof panels. Starting with the **Short Roof** side, attach **Front and Rear Facia** (3/4" x 3 1/2" x 38 1/4" angle cut on ends) to end of roof plywood with 5 - 1 1/2" finishing nails per side. Facia end lines up with rafter ends. Do a dry run with side facia in **Step 90** before attaching.

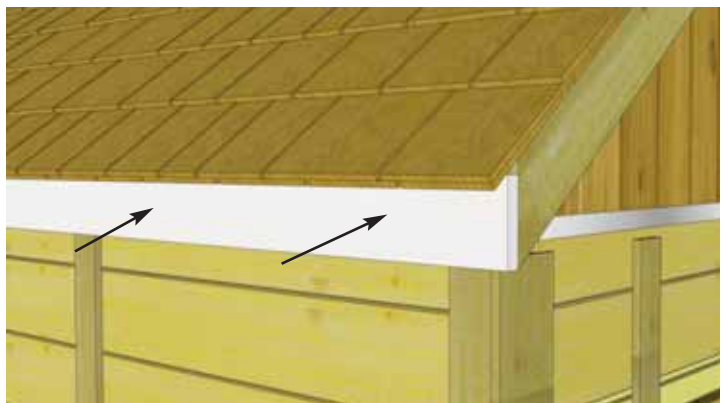

89. Attach **Side Facia** (3/4" x 3 1/2" x 72") to roof rafter ends. There are 2 pieces per side. Secure with 8 - 1 1/2" finishing nails per piece. Side Facia will sandwich Front and Rear Facia. Do a dry run with Front, Rear and Side Facia to confirm correct positioning prior to attaching.

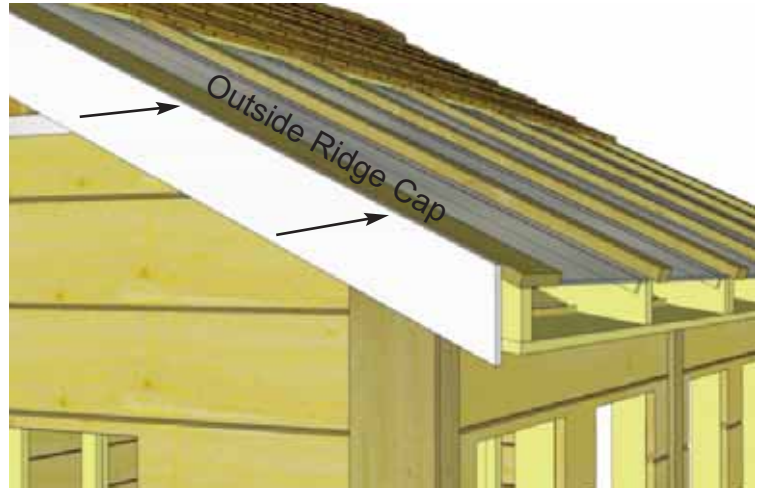

90. Attach **Long Front and Rear Facia** (3/4" x 3 1/2" x 78 3/4") to roof plywood and Outside Ridge Cap edge with 10 - 1 1/2" finishing nails and 2 - 1 1/2" screws. Use screws where Outside Ridge Cap and Facia meet. Once again, Line Facia up so it is aligned with rafter ends. Do a dry run with Front, Rear and Side Facia to confirm correct positioning prior to attaching.

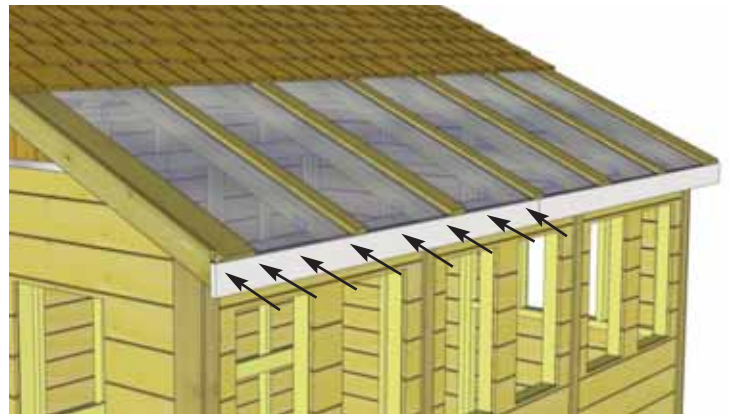

91. Attach remaining **Side Facia** to roof rafter ends as per **Step 89**.

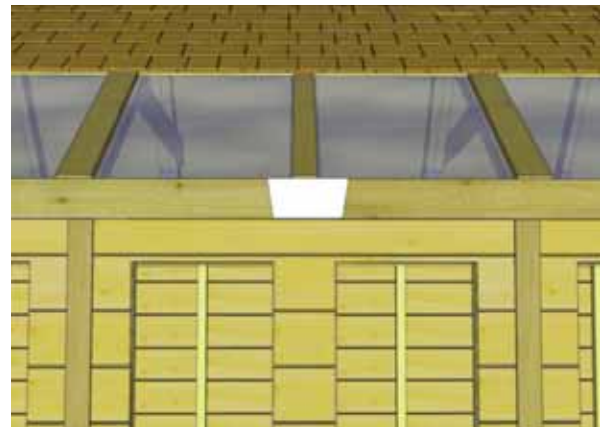

92. Attach **Facia/Trim Detail Plates and Pentagon Plates** to cover seams where Facia Trim pieces come together. Secure each with 4 - 1 1/2" finishing nails.



93. Attach both the **Horizontal Door Trim** (1/2" x 2 1/2" x 32") and **Horizontal Narrow Wall Trim** (1/2" x 2 1/2" x 8 3/4") with 4 and 2 finishing nails.

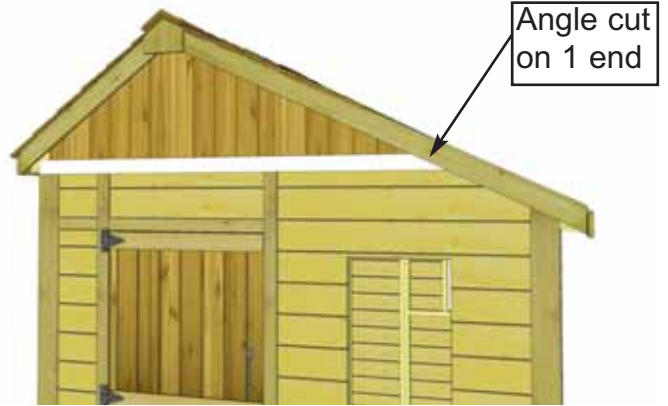

94. Locate **Horizontal Gable Trim** (1/2" x 4 1/2" x 85 1/2") for both front and rear of shed.



95. Position Horizontal Gable Trim so flush with outside edge of Wide Trim and top of Vertical Door Trim. Use 8 - 1 1/2" finishing nails per piece to secure. Complete both sides.

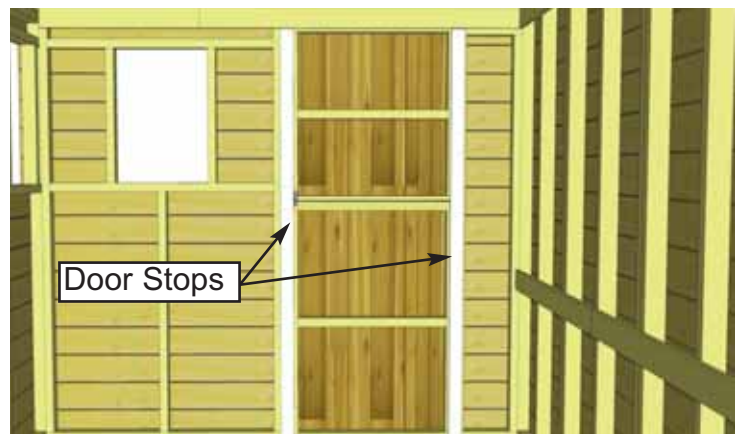

96. Attach Interior **Vertical Door Stops** (1/2" x 2 1/2" x 72") to door framing from inside of shed. Use 4 - 2" screws to secure each Stop. Stops should overlap door by approximately 1/2".

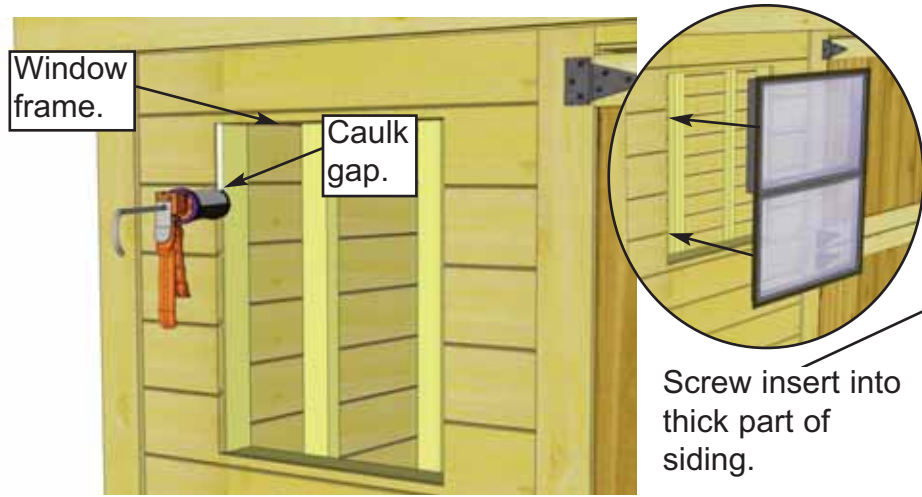

97. To reduce possible water from penetrating into the window cavity, caulk gap on both sides of window opening prior to installing **Window Insert**. Position insert in cavity and screw with **6 - 1 1/4" Screws**.

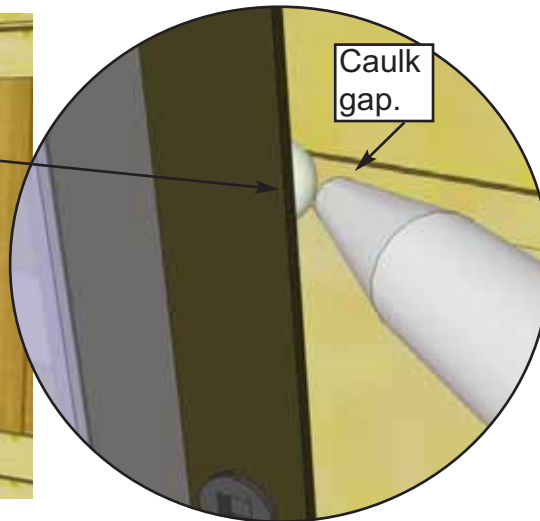

98. Once Insert is attached, caulk the "channel gap" between the Insert's outside flange and the siding. Also put a bead of caulking horizontally at top of window where the flange and siding meet. This additional caulking will also will reduce the chances of moisture entering into your shed.

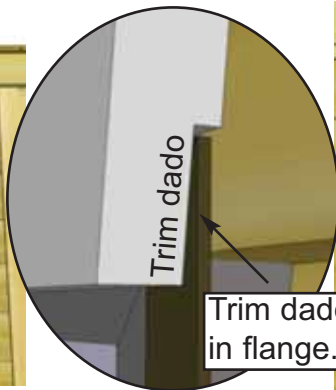

99. Position **Window Trim** around window doing a dry run first and attach with **4 - 1 1/2" Finishing Nails** per piece. Window trim has a small dado on reverse face. Outside flange of window will roughly sit in the dado to give a better fit.

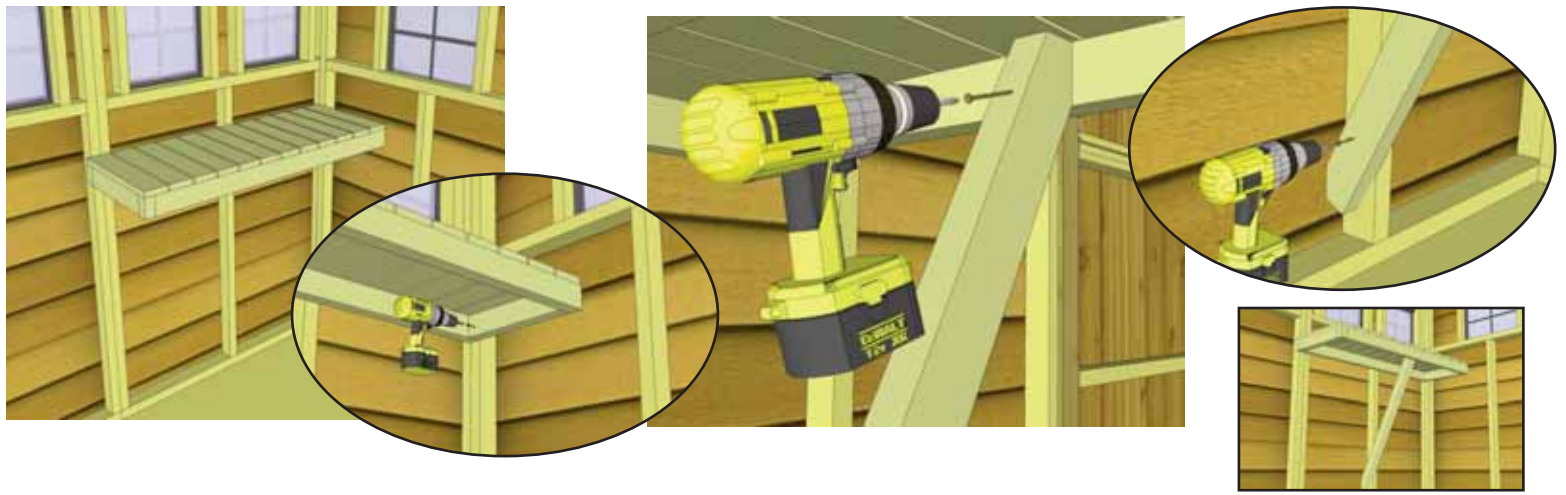

100. Locate 1 Long **Potting Shelf** and 1 **Leg**. Position shelf in corner tight against wall framing. While supporting the shelf, attach shelf with 2 1/2" screw. Place leg underneath shelf and attach to inside shelf frame and wall framing as illustrated above with 2 1/2" screws.

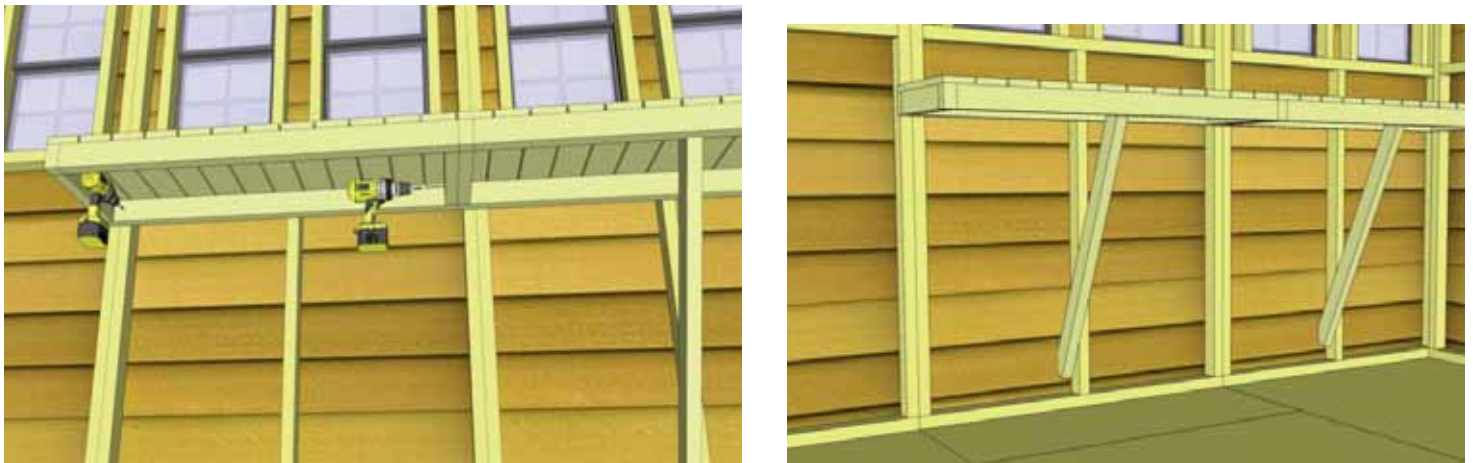

101. Place Short Potting Shelf against wall framing and end of long shelf framing. Attach with 2 1/2 " screws as per **Step 100**. Use a level to confirm shelving is square and level. Attach leg as previously illustrated. Screw to wall stud and up into the underside of the of shelf framing.

Complete attaching remaining long shelves as per **Steps 100 & 101**.



Completed
Potting Shelf

Outdoor Living Today Flower Box Assembly Instructions

Parts Lists:

A - Base, Rear & Front Box Frames	(3pcs)	3/4" x 5 1/2" x 23"
B - End Cap Frames	(2pcs)	3/4" x 5 1/2" x 7" / 8"
C - Front Trim	(1 pc)	3/4" x 1 1/2" x 26"
D - Side Trims	(2 pc)	3/4" x 1 1/2" x 8 3/4"
E - Brackets	(2 pc)	1 1/2" x 5 1/2" x 5 1/2"
F - 1 1/4" Screws		
G - 1 1/4" Nails		

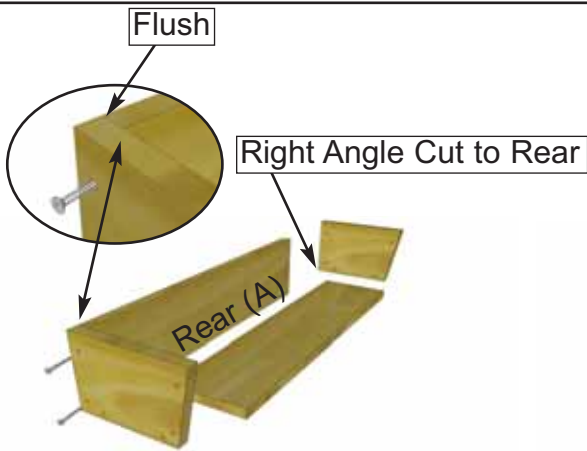
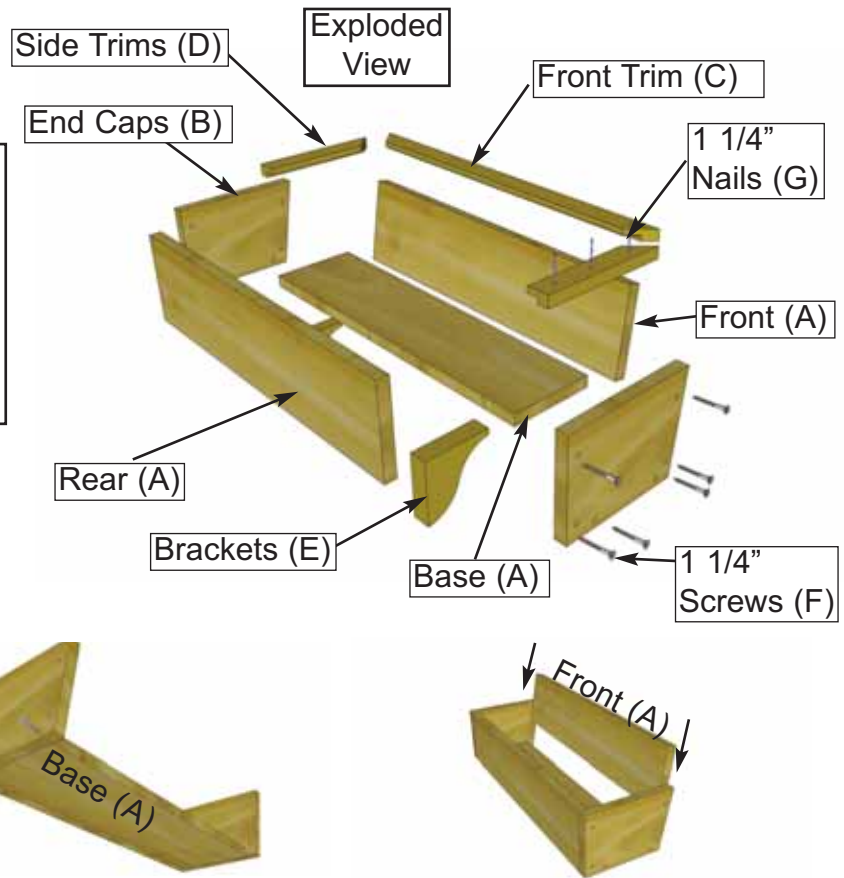

1. On a table position Rear Box and End Cap Frames together so flush at top. Fasten together with 2 - 1 1/4" screws. Place Base Frame tight against Rear and End Cap and flush at bottom. Secure with 2 - 1 1/4" screws. Complete attachment of remaining End Cap Frame. Slide Front Frame between End Caps.

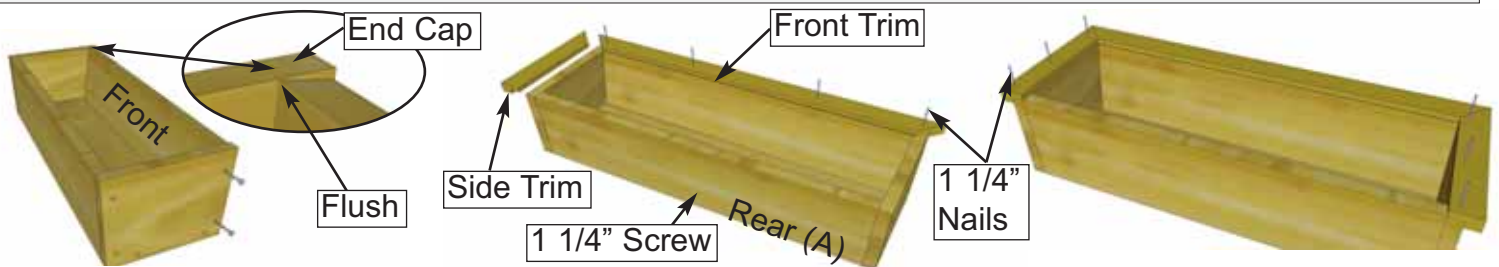

2. Position Front Frame Piece flush with End Cap. Attach both ends with 2 - 1 1/4" screws. Pilot hole Rear Box Frame near bottom center and secure to Base edge with 1 - 1 1/4" screw. Evenly position Front Trim (mitre cut on end and dado cut on inside bottom) tight against front frame and nail down with 4 - 1 1/4" nails. Position Side Trims as per Front and secure with 3 - 1 1/4" nails per side.

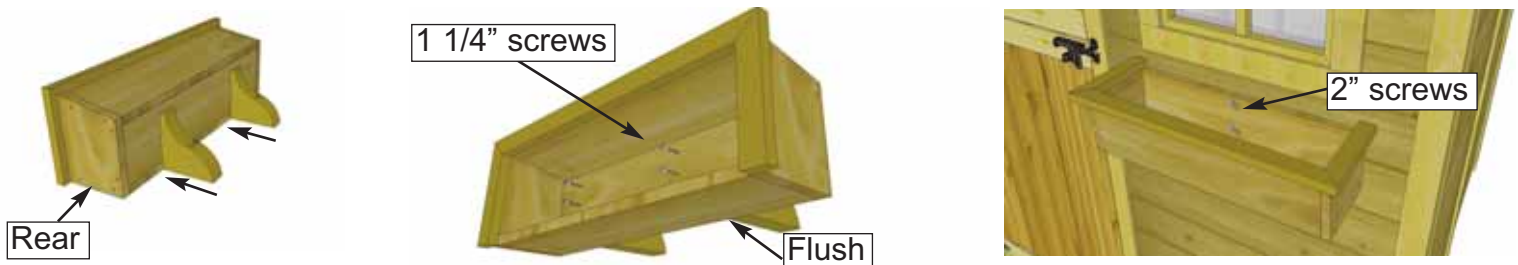

3. On a flat surface, flip Flower Box on it's rear face. Evenly space Brackets and secure through Base Frame and into the Brackets with 2 - 1 1/4" screws per Bracket. Position completed Flower Box beneath window trim and screw from inside of box into the center wall stud with 2 - 2" screws. (2" screws supplied with Base Kit.)



Congratulations on Completing your 8 x 12 Sunshed!

Note: Our buildings are shipped as an unfinished product. If exposed to the elements, the western red cedar lumber will weather to a silvery-gray color. If you prefer to keep the cedar lumber looking closer to the original color, we suggest that you treat the wood with a good oil base wood stain. You may also wish to paint your new shed rather than stain it. In both cases we recommend that you consult with a paint and stain dealer in your area for their recommendations.



We hope your experience assembling your Sunshed has been both positive and rewarding.

We value your feedback and would like to hear back from you on how well we are doing in the following areas:

1. Customer Service
2. On Time Shipping
3. Motor Freight Delivery
4. Quality of Materials
5. Assembly Manual
6. Overall Satisfaction.

Please call, write or email us at:

Outdoor Living Today

Canadian Address
9393 287th Street
Maple Ridge, British Columbia
Canada V2W 1L1

United States Address
P.O. Box 96
Sumas, Washington
USA 98295



The materials contained in this Assembly Manual may be downloaded or copied provided that **ALL** copies retain the copyright and any other proprietary notices contained on the materials. No material may be modified, edited or taken out of context such that its use creates a false or misleading statement or impression as to the positions, statements or actions.