

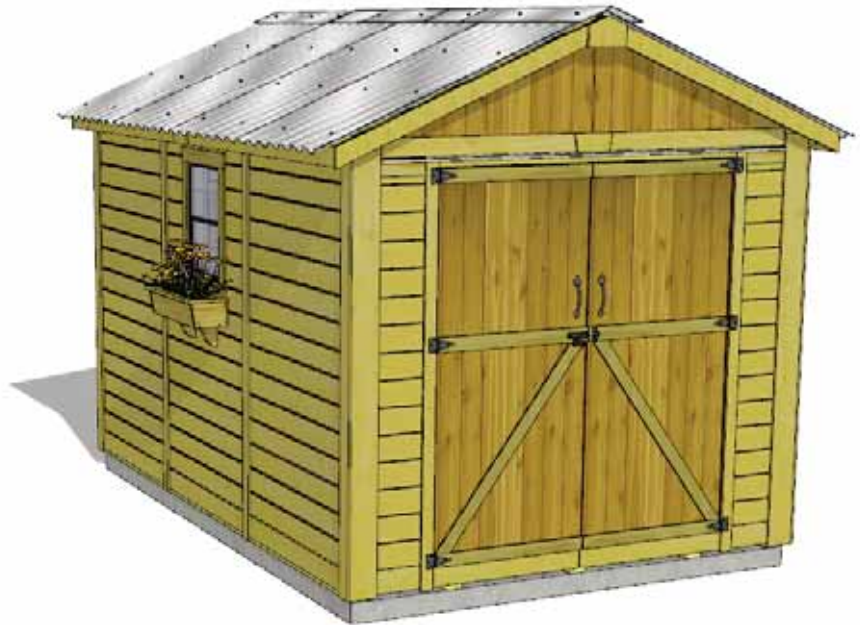

8x12 SpaceMaker - T&G with Metal Roof Assembly Manual

Version #1.1
February 4, 2022

Thank you for purchasing a 8x12 SpaceMaker. Please take the time to identify all the parts prior to assembly.
Stock Code #
SM812-Metal



Safety Points and Other Considerations
Our products are built for use based on proper installation on level ground and normal residential use. Please follow the instruction manual when building your shed and retain the manual for future maintenance purposes.

Customers are responsible for ensuring a solid, level, well-draining site for construction.

Please check with your local municipal or county by-laws before ordering this product to confirm it complies with building codes.

- Snow load ratings vary by geographical location. If heavy or wet snowfall occurs, it is advisable to sweep snow off roof frequently.
- If the product is elevated, any structural and building code requirements are solely the customer's responsibility, and should be abided by.
- In areas with high or gusty wind conditions, it is advisable to install the structure securely to the ground.
- Have a regular maintenance plan to ensure screws, doors, windows and parts are tightly affixed.



Customer agrees to hold Outdoor Living Today and any Authorized Dealers free of any liability for improper installation, maintenance and repair.

In the event of a missing or broken piece, call the Outdoor Living Today Customer Support Line @ 1-888-658-1658 within 30 days of the delivery of your purchase. It is our commitment to you to courier replacement parts, free of charge, within 10 business days of this notification. Replacement parts will not be provided free of charge after the 30 day grace period.

All structures purchased from Outdoor Living Today are covered for a period of one year for defects in manufacturing and workmanship. Costs incurred for customer installations are not included.

Failure to use supplied parts included in this kit could result in poor product performance and may void your warranty. Please contact Outdoor Living Today's Customer Toll Free Line if you plan to deviate from our written instructions.

What to do before my Shed arrives?



- Become familiar with this assembly manual and determine if you can complete the project yourself or will require a professional contractor.



- One helper is recommended to assist in constructing your shed. It generally takes two people over two days to assemble a shed. If you're hiring a contractor, their rate should be in line with that duration of work.



- Clear the construction area and ensure a clear pathway for delivery when the freight company arrives. Remove all debris: roots, grass, rocks, etc.



- Excavate the site. Contact your local utilities company to ensure there are no gas or electric lines buried in the area before digging.



- Decide on the type of foundation you will be using:
 - Concrete slab, or
 - 4-6 inches of crushed gravel with paver stones or 4x4 stringers.

You can find the footprint for your shed on Page 3 of your Assembly Manual.

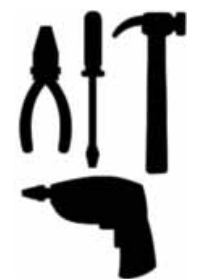

- If doing the assembly yourself, have all the necessary tools ready to go and in working condition. A list of required tools can be found after the parts list.

Foundation Types for 8x12 Garden Shed

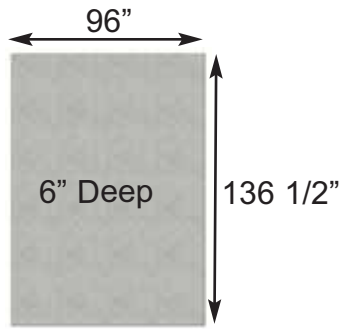

Concrete Foundation

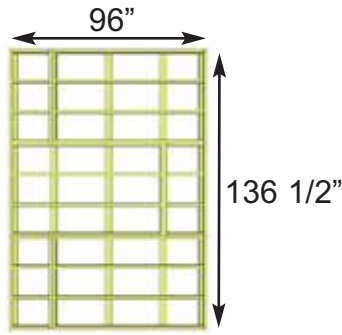

Floor Frame



Completed Foundation

Concrete Slab Foundation:

- Slab must be at least the same size as assembled floor frame (136 1/2" x 96") or larger.
- 6" Deep foundation.
- 1.7 Cubic Yards of concrete required.
- A concrete slab will have the longest durability out of your foundation options.

Once level, a concrete slab is the easiest surface to build on.

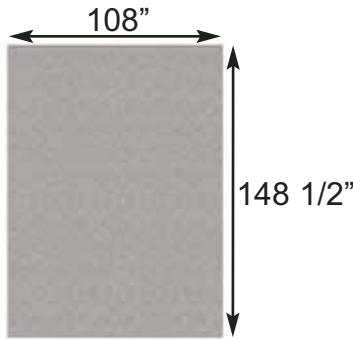

Gravel Foundation

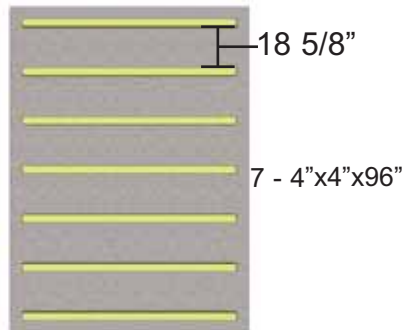

Gravel Foundation with treated stringers



Completed Foundation

Gravel with 4x4 Pressure Treated Stringers:

- Excavate at least 6" deep, and 6" wider than floor frame on each side.
- 2.1 Cubic Yards of gravel required, approximately 19 wheelbarrows.
- 7 - 4x4 Pressure Treated Stringers 8' long required.
- Evenly spaced, with one at each end of floor frame.

Saves money on materials, easy to level and work with.

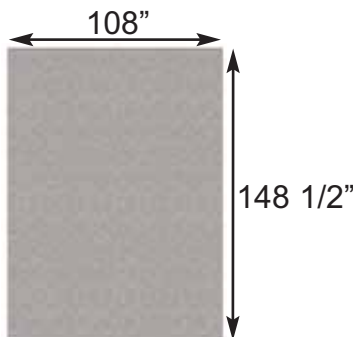

Gravel Foundation



Gravel Foundation with Patio Pavers

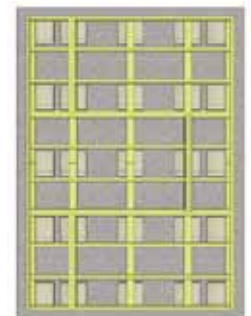

Completed Foundation

Gravel with Patio Paver Stones:

- Excavate at least 6" deep, and 6" wider than floor frame on each side.
- 2.1 Cubic Yards of gravel required, approximately 19 wheelbarrows.
- 25 patio pavers (8" x 8" or larger).
- Center patio paver stones underneath floor runners and underneath seams in floor joists.

Patio paver stones are widely available from most landscape stores.

Thank you for purchasing our 8x12 SpaceMaker Garden Shed.
Please take the time to identify all the parts prior to assembly.

A. Floor Section	Parts List - Pages 4 and 5	Steps ↓
Floors ----- 3 - 45 1/2" x 75" - Floor Joist Frames - Large 3 - 45 1/2" x 21" - Floor Joist Frames - Small 6 - 1 1/2" x 3 1/2" x 71 7/8" - Center Floor Joists - Unattached 10 - 1 1/2" x 3 1/2" x 68 3/16" - Floor Runners 3 - 45 3/8" x 74 7/8" - Plywood Floor - Large 3 - 45 3/8" x 20 7/8" - Plywood Floor - Small		1-12
B. Wall Section Main Wall Panels ----- 4 - 45 1/2" x 75" - Solid Wall Panels 4 - 34 1/8" x 75" - Small Solid Wall Panels 4 - 1 1/2" x 2 1/2" x 45 1/2" - Bottom Wall Plates Long 4 - 1 1/2" x 2 1/2" x 34 1/8" - Bottom Wall Plates Short 1 - 45 1/2" x 75" - Window Wall Panels 2 - 12" x 73" - Narrow Wall Panels Door Header & Jamb ----- 2 - 1 1/2" x 3 1/8" x 73" - Vertical Door Jamb 1 - 2" x 3 1/8" x 78" - Door Header - Long (Dado on edge) 2 - 2" x 3 1/8" x 6 1/2" - Door Headers - Short (Dado on edge)		Steps ↓ 13-19
Top Wall Plates & Gables ----- 6 - 3/4" x 2 1/2" x 32" - Front & Rear Top Plates (4 pieces angle cut on end, 2 piece straight cut both ends) 4 - 3/4" x 2 1/2" x 65 3/4" - Side Top Plates (angle cut edge) 4 - Gable Half Walls - Triangular Shaped		20-22 24-27
C. Rafter and Roof Section Rafter Assembly ----- 4 - 3/4" x 4 1/2" x 84" & 52 1/2" - Ridge Boards 18 - 1 1/2" x 3 1/2" x 56 1/2" - Roof Rafters 4 - 1/2" x 4 1/2" x 68 1/4" - Soffits 3 - 3/4" x 3 1/2" x 72" - Roof Gussets (angle cut on ends) 4 - 3/4" x 2 1/2" x 51" - Facia Nailing Strips Roof ----- 16 - 3/4" x 3 1/2" x 49 1/4" Roof Batten (Outside) 12 - 3/4" x 1 1/2" x 14 1/8" - Batten Spacers 8 - 3/4" x 3 1/2" x 45 1/2" Roof Batten (Middle) 8 - 58" long x 39" wide - Metal Roof Panels 3 - 60" long 13" wide - Metal Ridge Caps Several Pcs - Foam Enclosure for Metal Roof		Steps ↓ 28-41 42-59
D. Trim & Miscellaneous Section Outer Wall Trim ----- 7 - 1/2" x 4 1/2" x 45 1/4" - Bottom Skirting Long 4 - 1/2" x 4 1/2" x 34 1/8" - Bottom Skirting Short 4 - 5/8" x 2 1/2" x 75" - Filler Trim 2 - Metal Drip Caps 2 - 1/2" x 4 1/2" x 43 1/4" - Rear Horizontal Gable Trim 2 - 1/2" x 4 1/2" x 43 1/4" - Front Horizontal Gable Trim 4 - 1/2" x 3 1/2" x 79" - Corner Trim 4 - 1/2" x 5 1/2" x 82" - Wide Corner Trim 5 - 1/2" x 2 1/2" x 79" - Side Wall Narrow Trim 1 - 1/2" x 2 1/2" x 77 1/2" - Rear Wall Narrow Trim 2 - 1/2" x 2 1/2" x 79" - Vertical Door Trim 1 - 1/2" x 1 1/2" x 64" - Horizontal Door Trim 2 - 1/2" x 1 1/2" x 9" - Horizontal Narrow Wall Trim Facia Trim ----- 4 - 3/4" x 3 1/2" x 58" - Front & Rear Facia (Angle cut ends - 2R/2L) 4 - 3/4" x 3 1/2" x 71 3/4" - Side Facia 2 - Pentagon Facia Plates - For Front & Rear Facia Peaks 2 - Horizontal Gable Trim Detail Plates - 4 1/2" high 2 - Side Facia Detail Plates - 3 1/2" high		Steps ↓ 60-72 73-75

Continued on next page

Note: All Trim, Facia and Bottom Skirting pieces will be positioned rough face out when installed.

Before/During Assembly:

- 1.) Paint each face and edge of your plywood floor with a latex exterior paint.
- 2.) Caulk wall seams if gaps appear.
- 3.) Caulk around window framing.
- 4.) Caulk perimeter between floor plywood and bottom wall plate.
- 5.) Caulk channels in lap siding at the top of your door above the trim, just a drop in each channel.
- 6.) Caulk edge of door threshold (if applicable).
- 7.) Optional: Install a Sill Gasket between floor runners and foundation.
- 8.) Optional: Install an 8" strip of roofing paper below Cedar Ridge Caps for Cedar Roof Sheds.

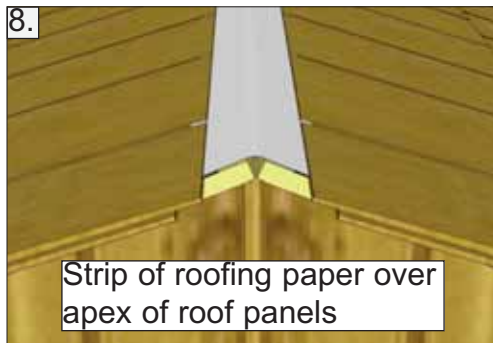
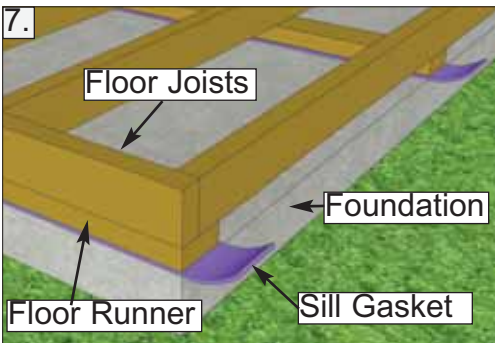
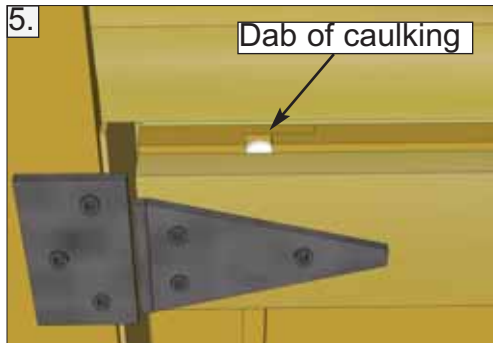
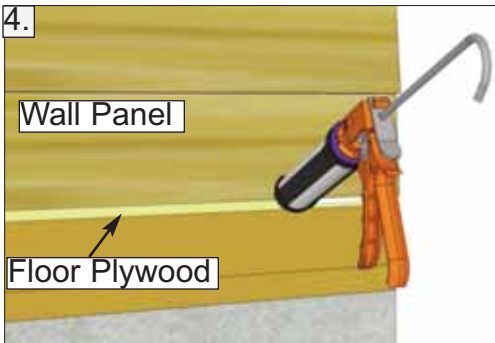
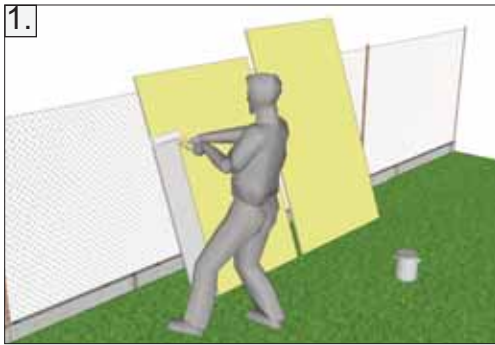

Routine Maintenance:

- Routinely check all fasteners are tight (ex. Door Hinges, Nails)
- Brush off dirt from walls.
- Brush off snow from roof regularly.
- Routinely remove needles and leaves from roof.

Painting/Staining

- Your cedar shed, if left untreated, will weather to a silvery grey colour.
- Painting or staining your structure is highly recommended and will prolong the life of your shed.
- You do not need to wait to paint or stain your shed, the wood in your kit has been dried and can be stained or painted immediately.
- Consult your local paint store for the best paint or stain for cedar.
- Optional: stain the inside of your shed. (Note: this will remove the fresh cedar smell.)

A. Floor Section

Exploded view of all parts necessary to complete Floor Section. Identify all parts prior to starting. Note: Floor Footprint is 136 1/2" wide x 96" deep.

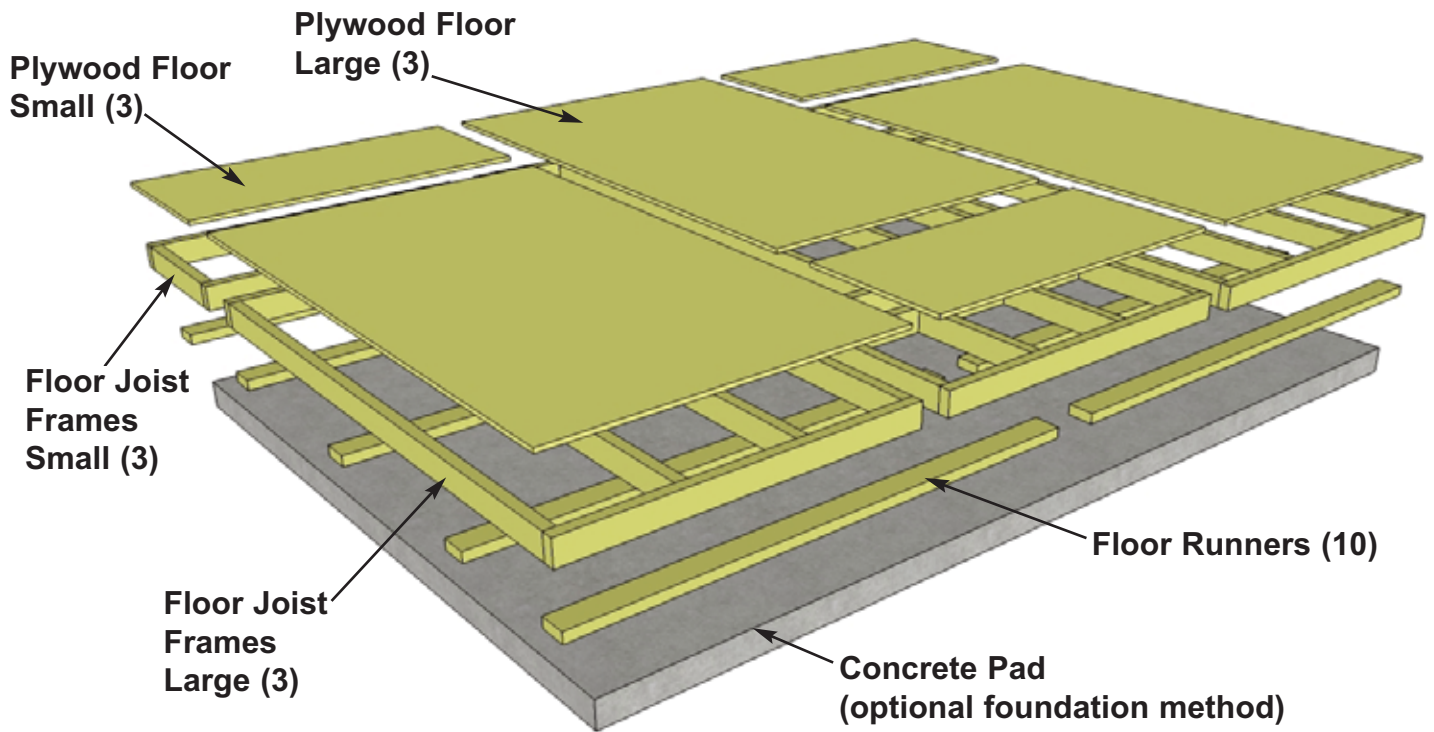

Flush with framing



1. Lay out **Large Floor Joist Frame** and **2 Floor Joists** as illustrated above. Position Joists equally in Floor Joist Frame. Use **Small Floor Joist Frame** as a template to determine joist position. Position Joist so flush with framing.

Parts (Steps 1 - 6)

Floor Joists

(1 1/2" x 3 1/2" x 71 7/8") x 6

Floor Joist Frames - Large

(45 1/2" x 75") x 3

Floor Joist Frames - Small

(45 1/2" x 21") x 3

Hardware (Steps 1 - 6)

S1 - 2 1/2" Screws

x 58 total

You can find the Square Drive Bit for the screws in with the Hardware Kit Bag.

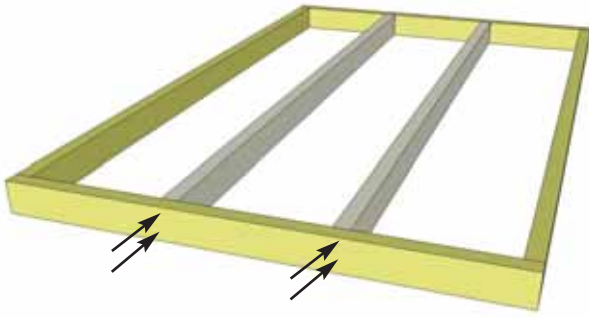

2. When correctly positioned, attach each Joist with **4 - 2 1/2" Screws** (2 per end). **You can find the Square Drive Screw Bit in the Hardware Kit Bag.**

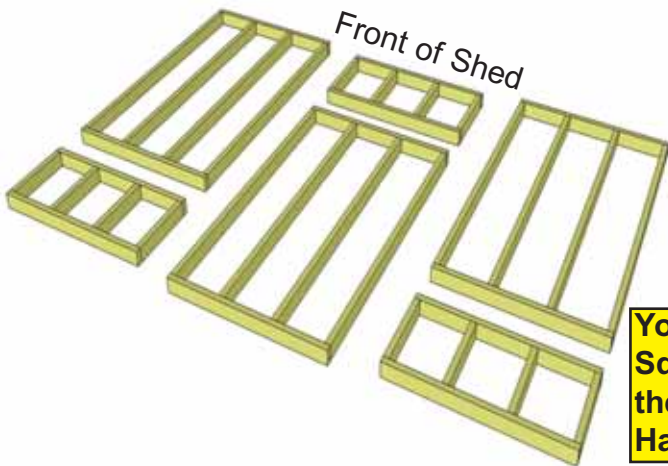

You can find the Square Drive Bit for the screws in with the Hardware Kit Bag.

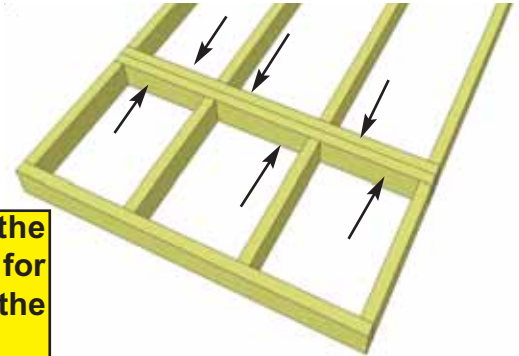

3. Lay out **Floor Joist Frames** as illustrated. There are 3 larger and 3 smaller Frame Sections. The Footprint for the floor when attached together will be **136 1/2" wide x 96" deep**.

4. Attach each large and small floor joist frame together with **6 - 2 1/2" Screws** per section.

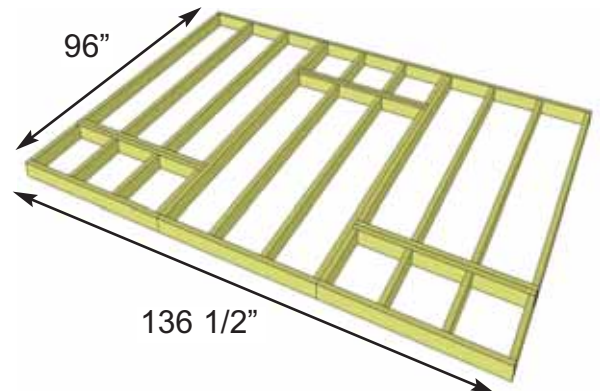

5. Complete all large and small frame attachments. Screw each completed section together with **8 - 2 1/2" Screws**.

6. When completed, your floor footprint should be **136 1/2" wide x 96" deep**.

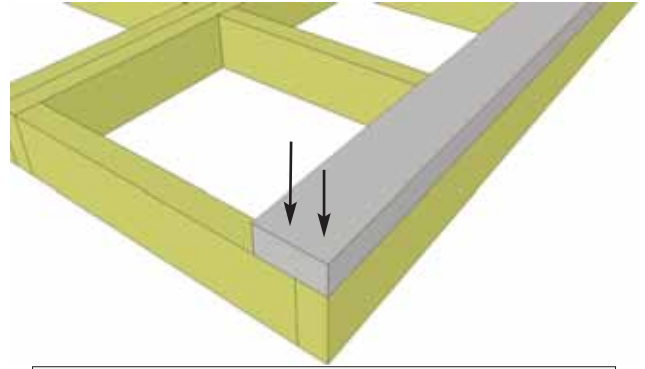
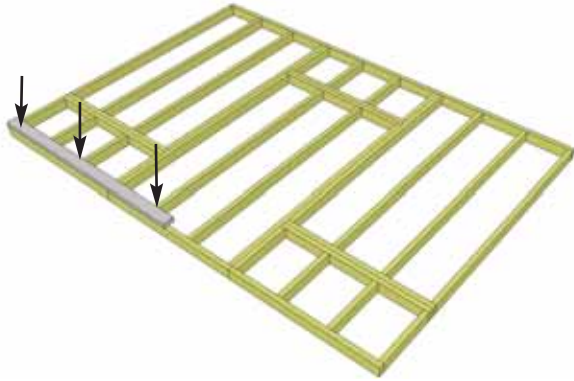

7. Attach **Floor Runners** to completed floor frame. There are 2 Floor Runners per 136 1/2" side and 5 completed Runners in total. Use **6 - 2 1/2" Screws** per Runner.

8. Make sure Runners are flush with outside and front and rear floor framing but not overhanging.

<u>Parts (Steps 7 - 9)</u>	<u>Hardware (Steps 7 - 9)</u>
Floor Runners (1 1/2" x 3 1/2" x 68 3/16") x 10	S1 - 2 1/2" Screws x 60 total

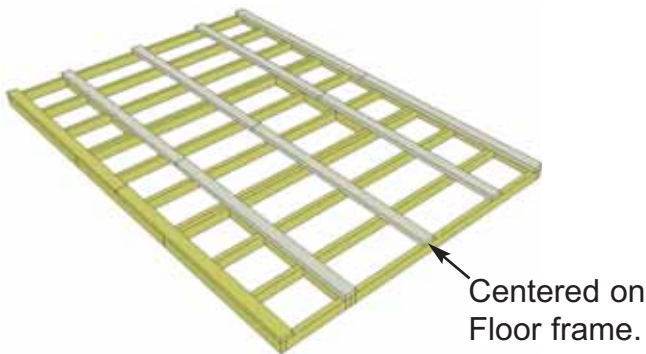

Foundations

Note: The floor will be flipped over and the floor runners will sit on your foundation. It is important to note, that having a level foundation is critical. Choosing a foundation will vary between regions. Typical foundations can be concrete pads or patio stones positioned underneath the floor runners.

9. Complete remaining Floor Runners.

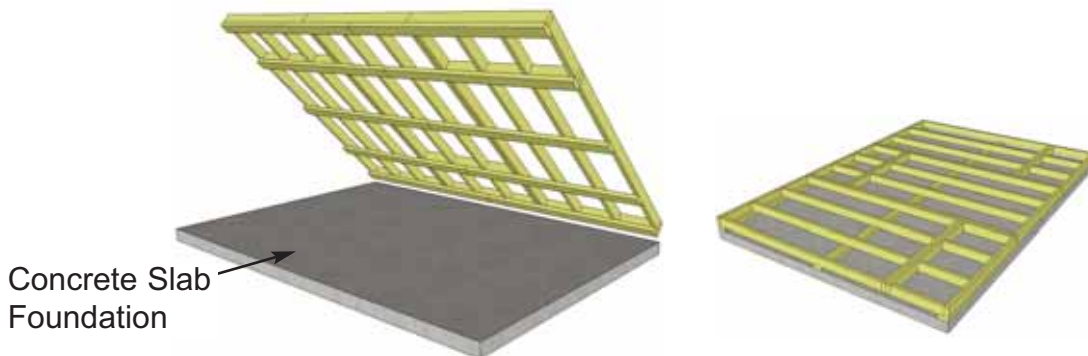

10. With Floor Runners attached, carefully flip the floor over and place on your foundation.

Caution: you will need 2 people to assist you. Be careful when laying floor down not to bend or twist floor. When in place, level floor completely.

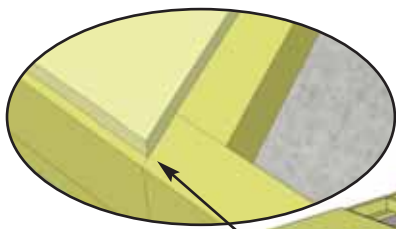

Important - Make sure floor is level before moving on to wall section. Use a level to confirm, and shim floor joists as required.

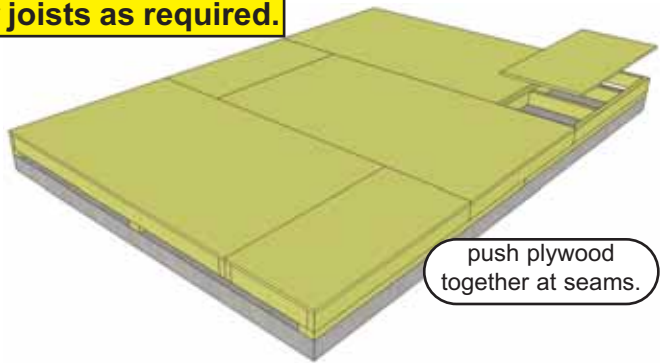
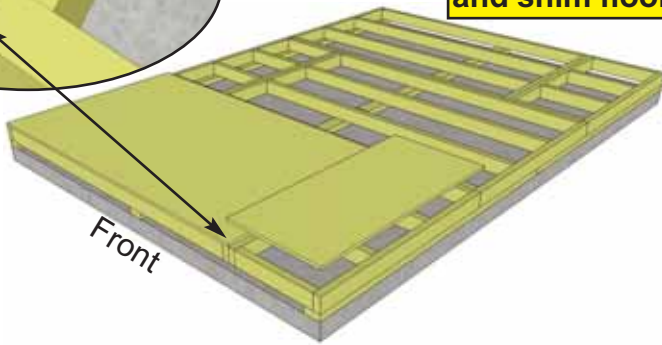

push plywood together at seams.

11. Position all **Large & Small Plywood Floor** pieces on top of completed floor joists. The Plywood is cut slightly smaller than Floor framing. Keep Plywood seams tight.

Parts (Steps 11 - 12)

Plywood Floor - Large

(45 3/8" x 74 7/8") x 3

Plywood Floor - Small

(45 3/8" x 20 7/8") x 3

Hardware (Steps 11 - 12)

S2 - 1 1/4" Screws

x 70 total (approx)

Hint: Use a chalk line to mark location of floor joists to determine screw placement.

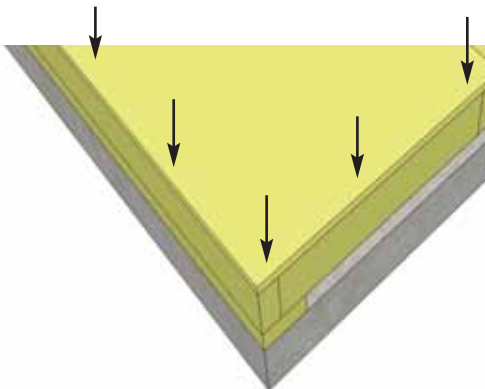
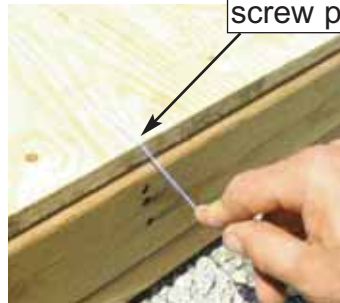

12. With Plywood positioned correctly on floor framing, attach with **1 1/4" Screws**. Use screws every 16".

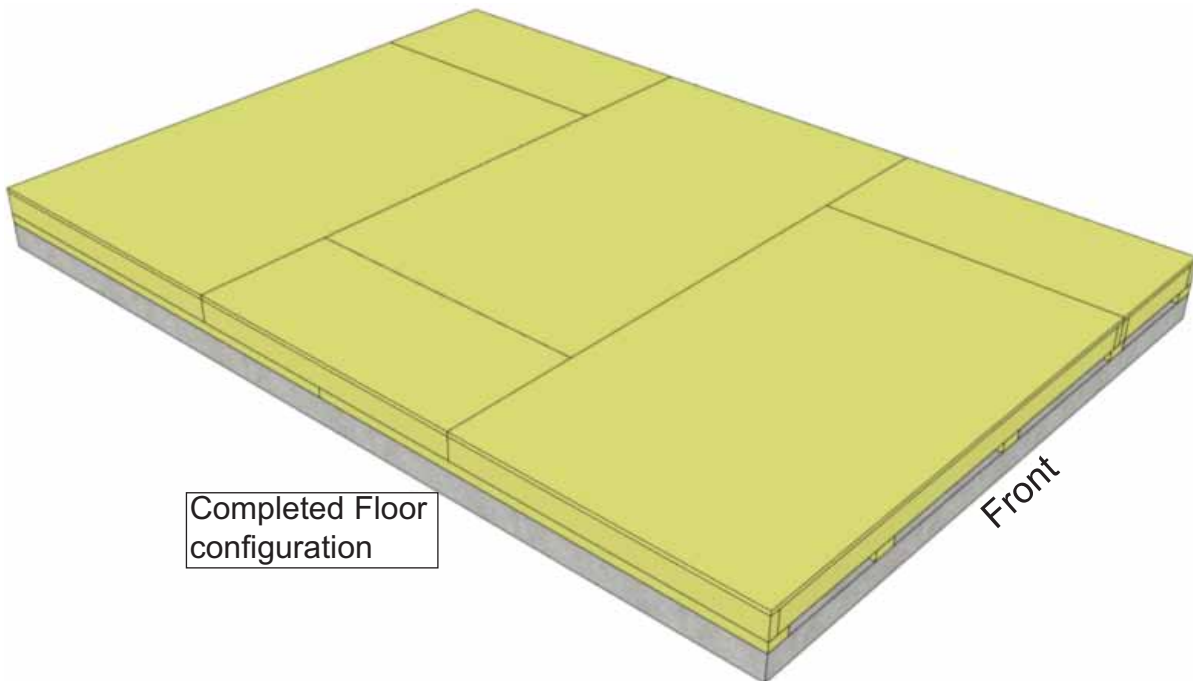

Completed Floor configuration

B. Wall Section

Exploded view of all parts necessary to complete the Wall Section.
Identify all parts prior to starting.

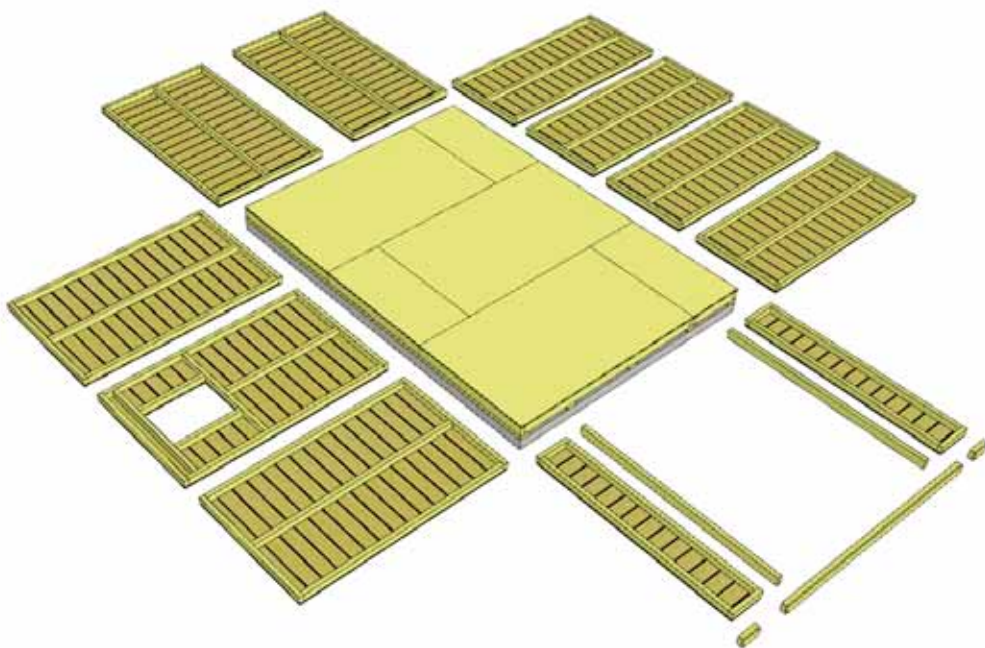
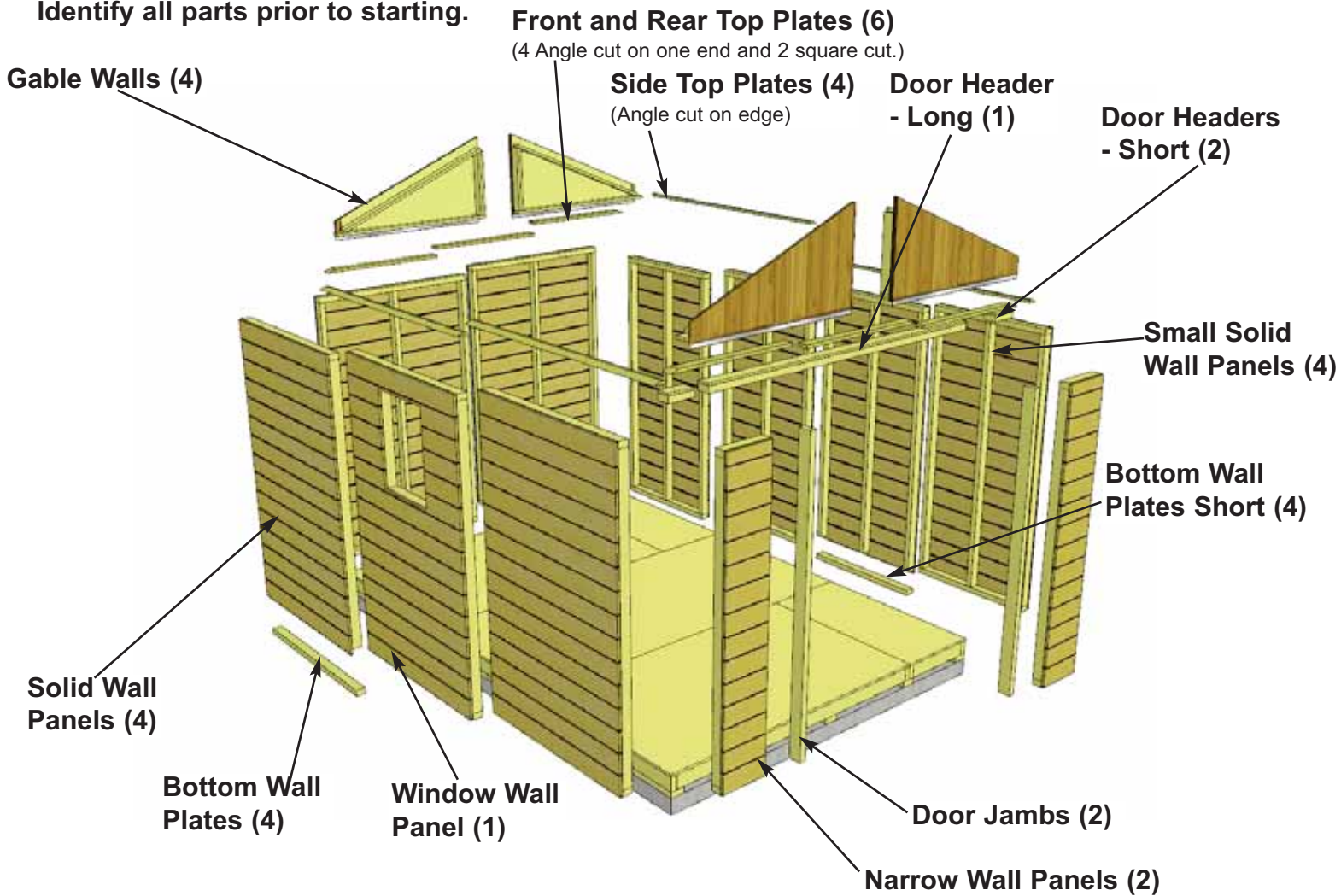

13. Lay out all the wall panels and become familiar with their location.

On Standard Kits, there are **4 Solid Wall Panels, 4 Small Solid Wall Panels, 2 Narrow Wall Panels, and 1 Window Wall Panel.**

Make sure to position panels right side up so water is directed away from and not into shed. Look at window wall panel to compare and determine proper wall position.

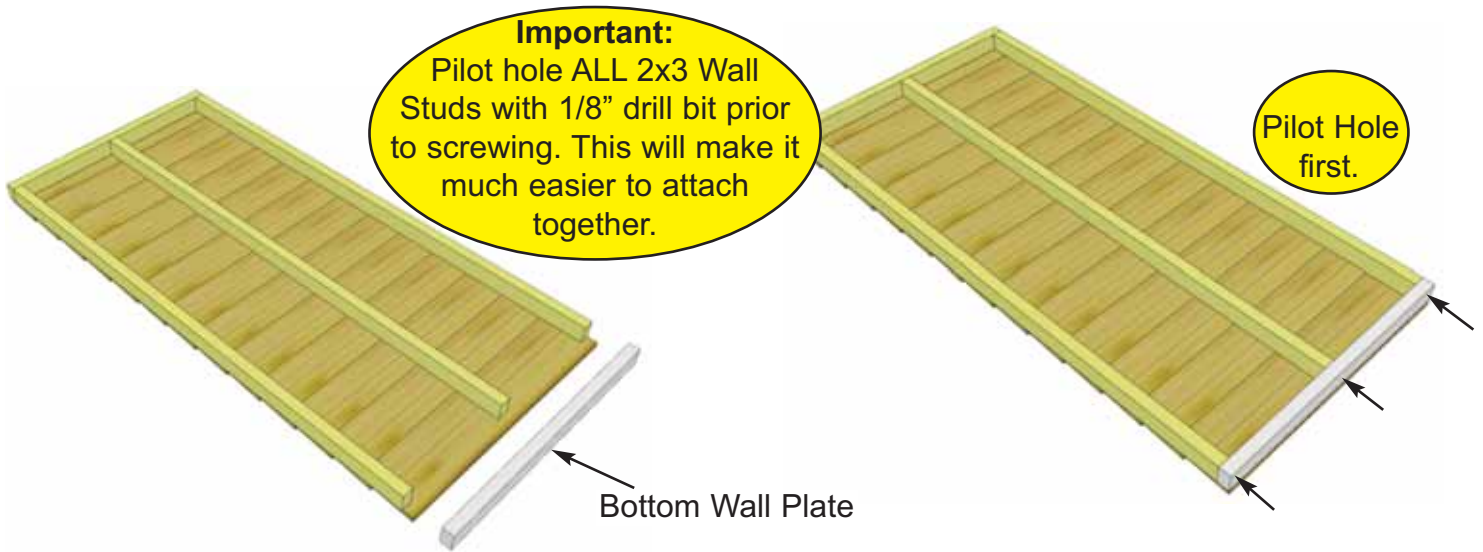

14. For each **Solid Wall Panel/Small Solid Wall Panel**, carefully lay panel face down. Position and attach a **Bottom Wall Plate Long/Bottom Wall Plate Short** to bottom of wall studs of each wall panel with **3 - 2 1/2" Screws**. Position so plates are flush with framing.

Parts
Solid Wall Panels (45 1/2" x 75") x 4
Bottom Wall Plates Long (1 1/2" x 2 1/2" x 45 1/2") x 4
Small Solid Wall Panels (34 1/8" x 75") x 4
Bottom Wall Plates Long (1 1/2" x 2 1/2" x 34 1/8") x 4

Hardware
S1 - 2 1/2" Screws x 24 total

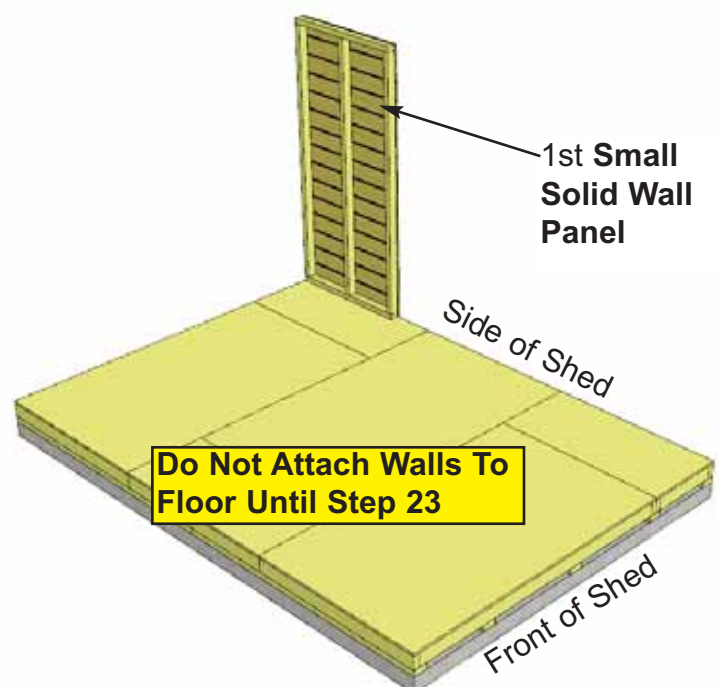
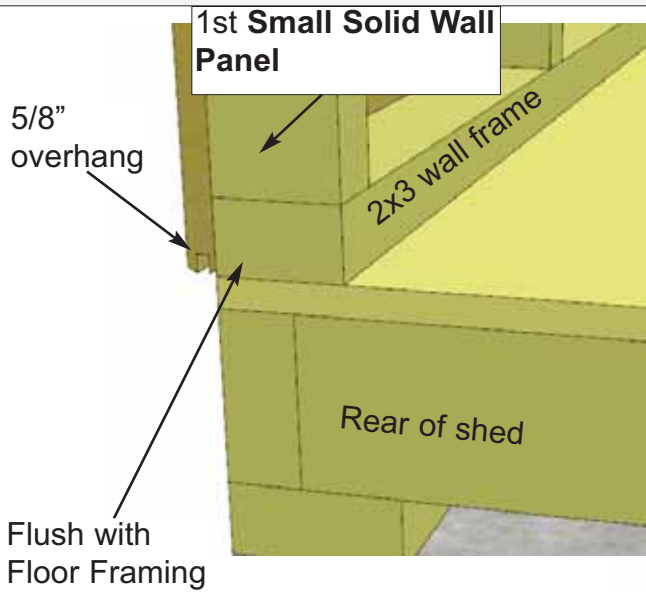

Important - Make sure all walls are aligned in their upright position. If not, water may leak into your shed. Unsure if panel is facing up or down? Compare solid wall siding to window wall siding and match orientation.

15. Starting at Rear Corner, position a **Small Solid Wall Panel** on top of Plywood Floor. The Wall Panel bottom framing will sit flush with Floor framing. Wall siding will overhang the floor. The Side Wall panels will sit flush at the end of the Plywood Floor with the Rear Wall panels sandwiched between them. **Note:** Siding will overhang the Floor by approximately 5/8".

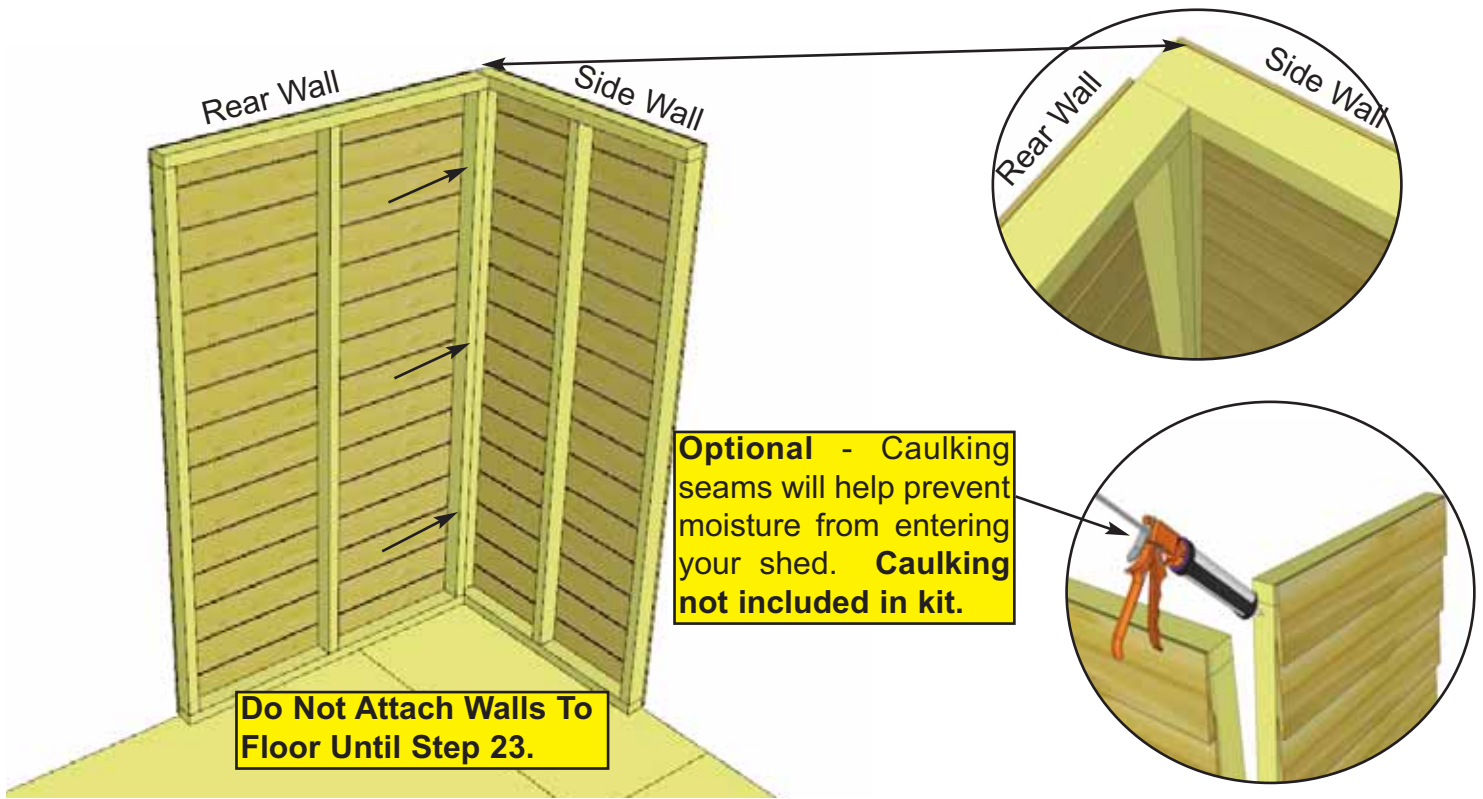

16. Position a Rear Wall into place on plywood floor. Butt both vertical wall studs of Side and Rear Walls together and attach with **3 - 2 1/2" Screws**. Screw at the bottom, middle and top of stud to secure properly.

Hardware (Steps 16 -18)
S1 - 2 1/2" Screws
 x 21 total

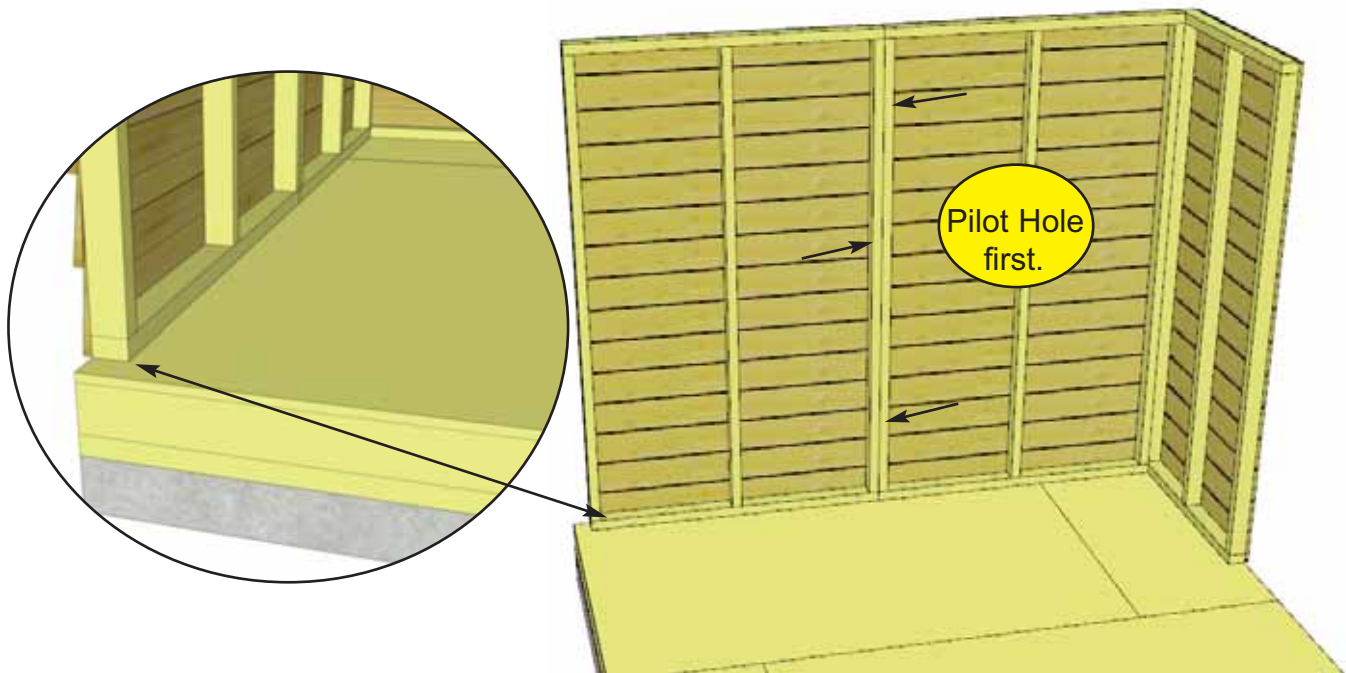

17. With the corner wall attachment complete, position a second Rear Wall panel in place so bottom 2x3 wall framing is sitting flush with outside floor joists and plywood floor. Wall siding should overhang floor by approximately 5/8". When positioned correctly, attach both Rear Wall panel studs together as shown.

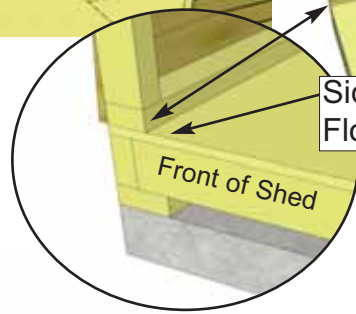
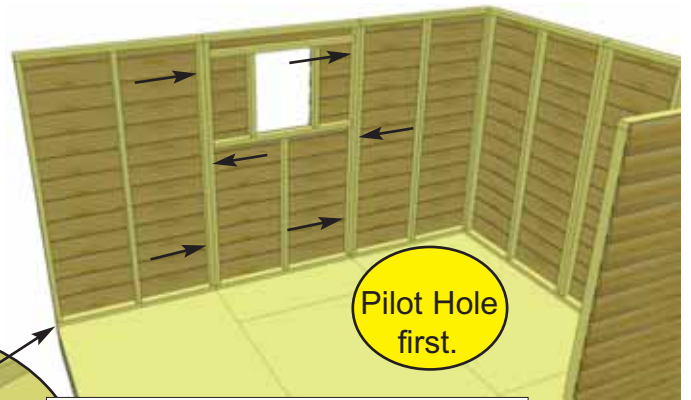
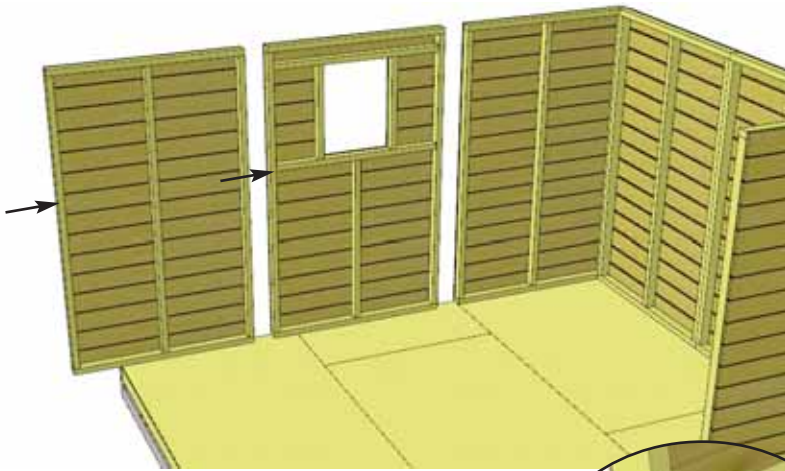
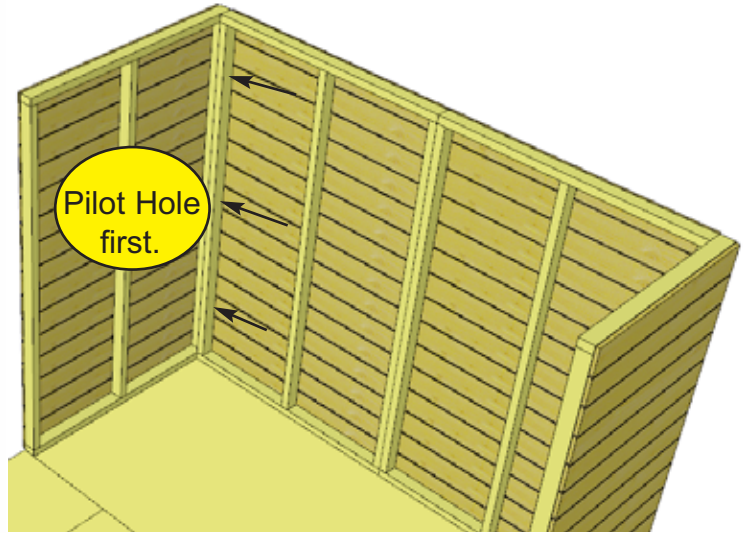
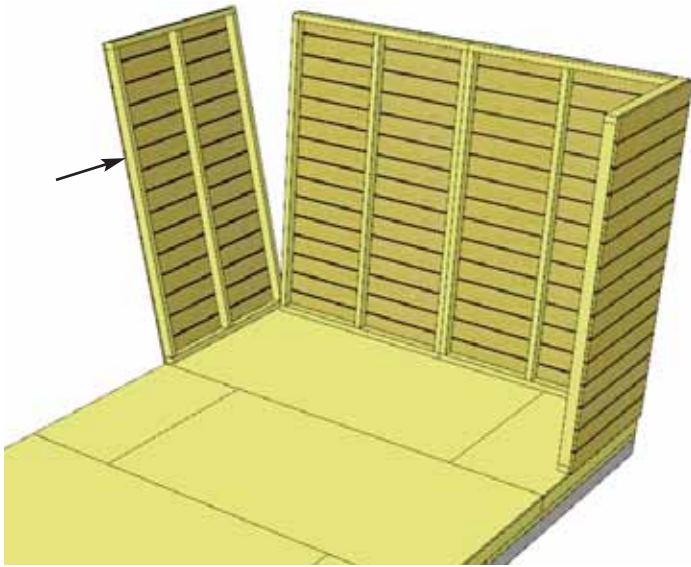

Side Wall Panel will sit flush with Floor framing at Front of Shed.

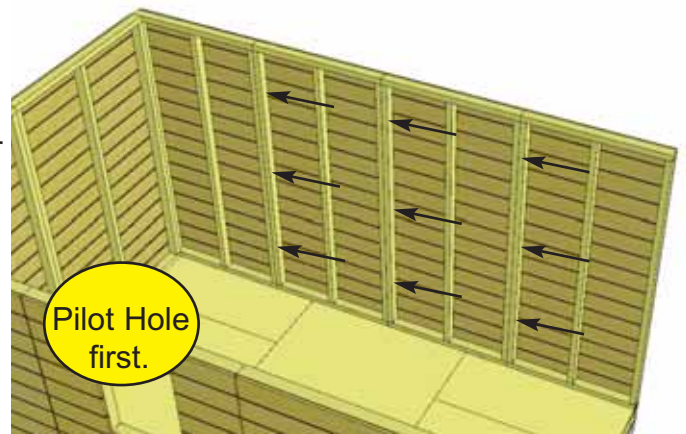
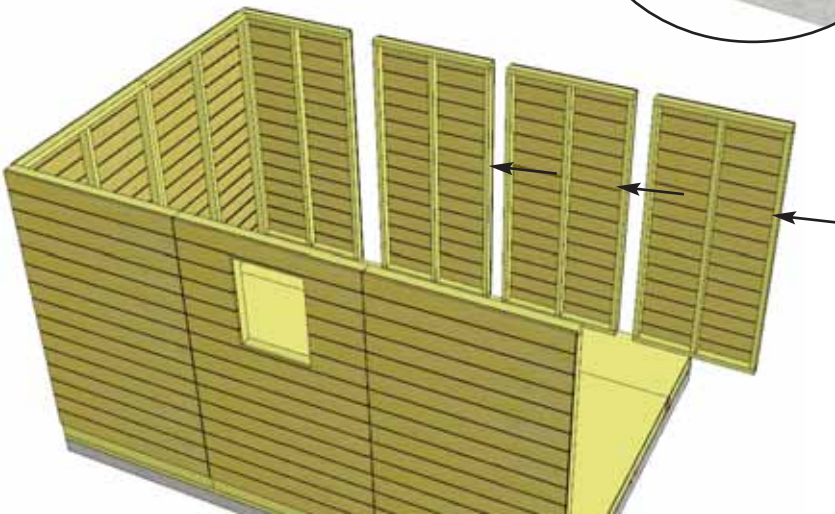

18. Complete all Side and Rear Solid Wall and Window Wall attachments as per **Steps 15 - 17**. Note that the four **Small Solid Wall Panels** make up the right side wall.

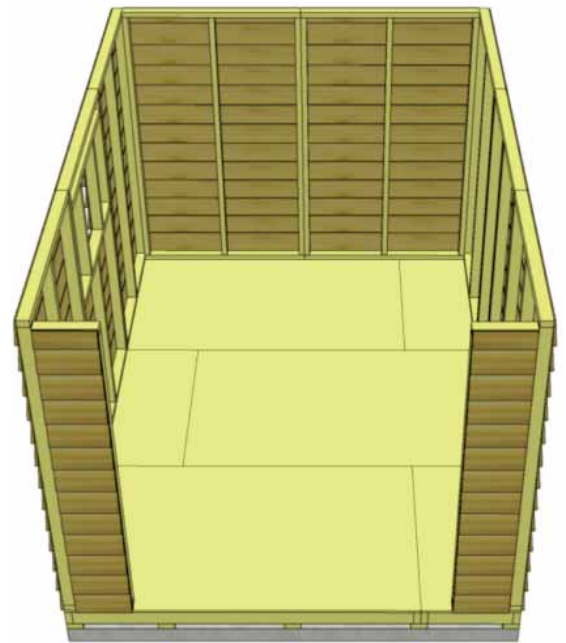
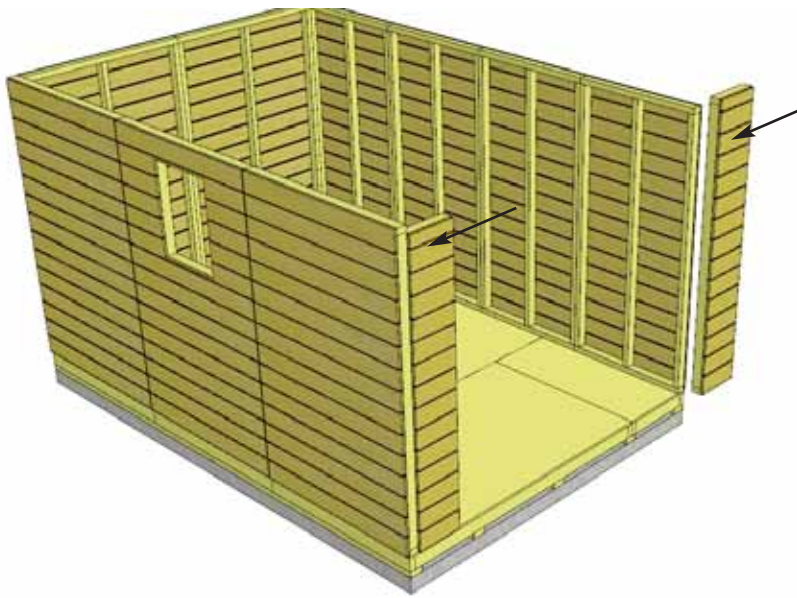

19. Position and attach both **Narrow Walls** as per **Steps 15 - 18.**

<u>Parts</u>
Narrow Walls (12" x 73") x 2
<u>Hardware</u>
S1 - 2 1/2" Screws x 6 total

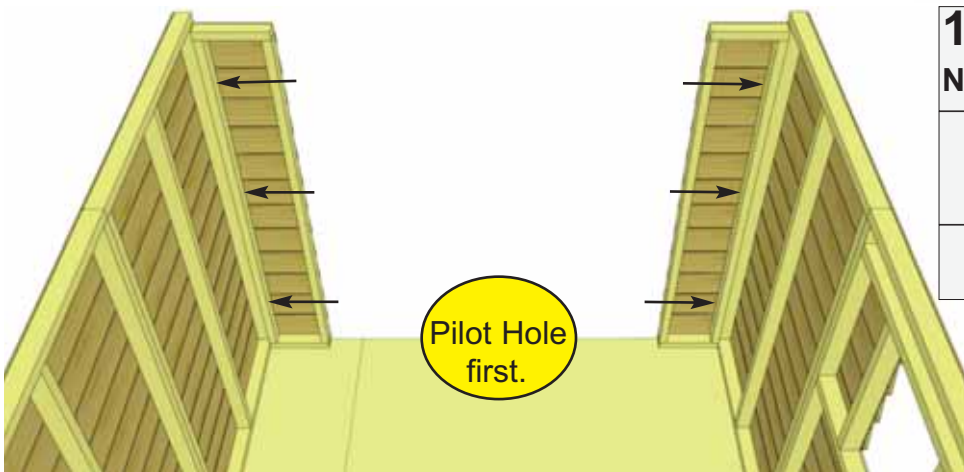

Pilot Hole first.

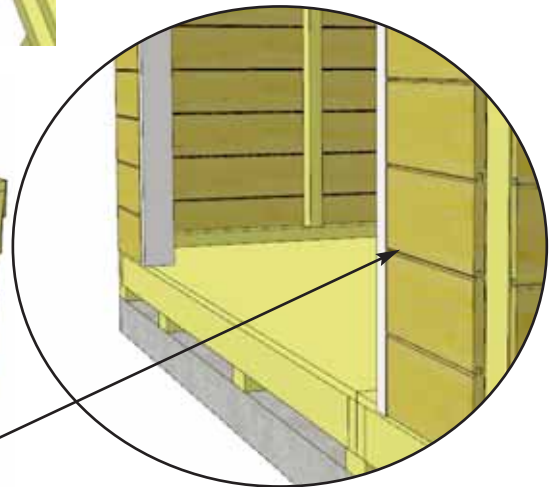

20. Attach **Vertical Door Jambs** to Narrow Wall studs in door opening with **4 - 2 1/2" Screws** each. Position so Jamb is flush with tip of T&G siding on front Narrow Walls. Complete both sides.

<u>Parts</u>
Vertical Door Jambs (1 1/2" x 3 1/8" x 73") x 2
<u>Hardware</u>
S1 - 2 1/2" Screws x 8 total

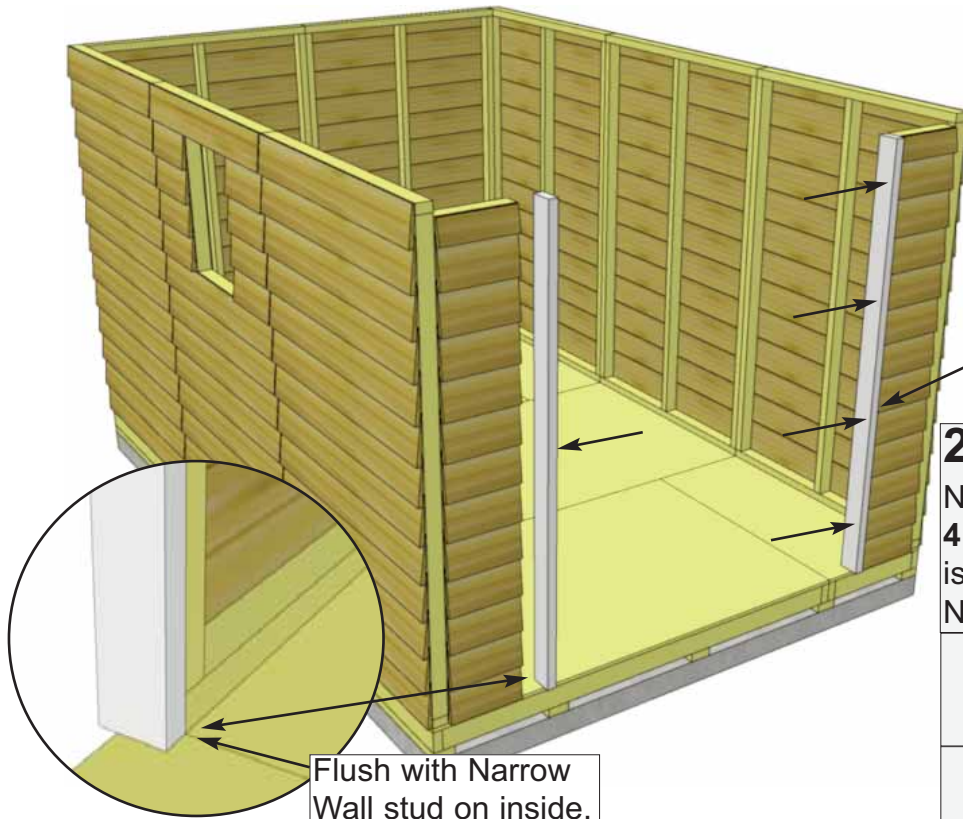

Flush with Narrow Wall stud on inside.

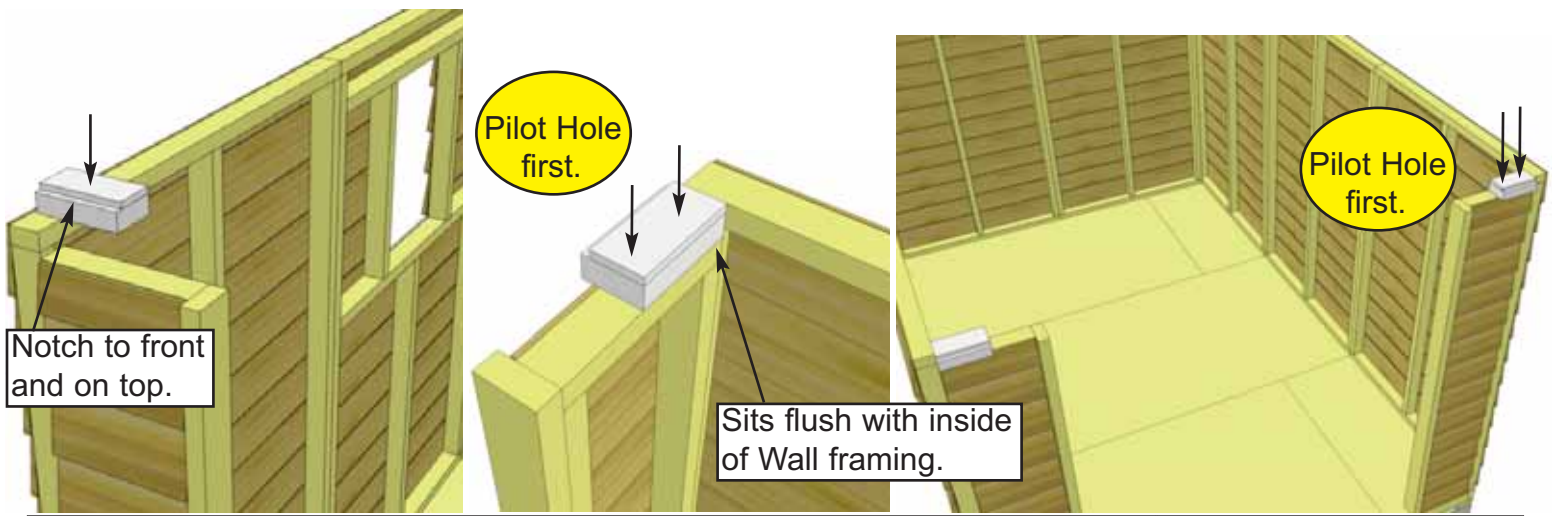

21. Attach **Short Door Headers** to Narrow Walls with **2 - 2 1/2" Screws** per piece. Header is 3 1/8" wide at bottom and has a 1/2" thick x 3" wide strip of wood stapled to the top creating a notch or dado effect. This notch needs to be positioned on the top facing the front. The notch is necessary to hold the drip cap that will be installed above the door in **Step 55**.
Pre-drill to prevent splitting!

<u>Parts</u> Door Headers - Short (2" x 3 1/8" x 6 1/2") x 2
<u>Hardware</u> S1 - 2 1/2" Screws x 4 total

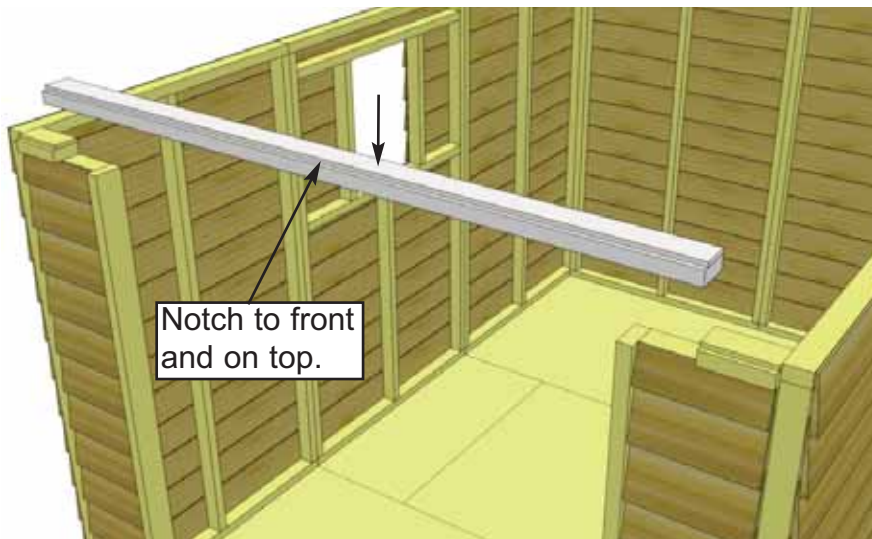

22. Attach **Long Door Header** to Vertical Door Jambs and Narrow Walls with **2 - 2 1/2" Screws** per side. Position the notch on the top facing the front as per **Step 21**.
Pre-drill to prevent splitting!

<u>Parts</u> Door Header - Long (2" x 3 1/8" x 78") x 1
<u>Hardware</u> S1 - 2 1/2" Screws x 4 total

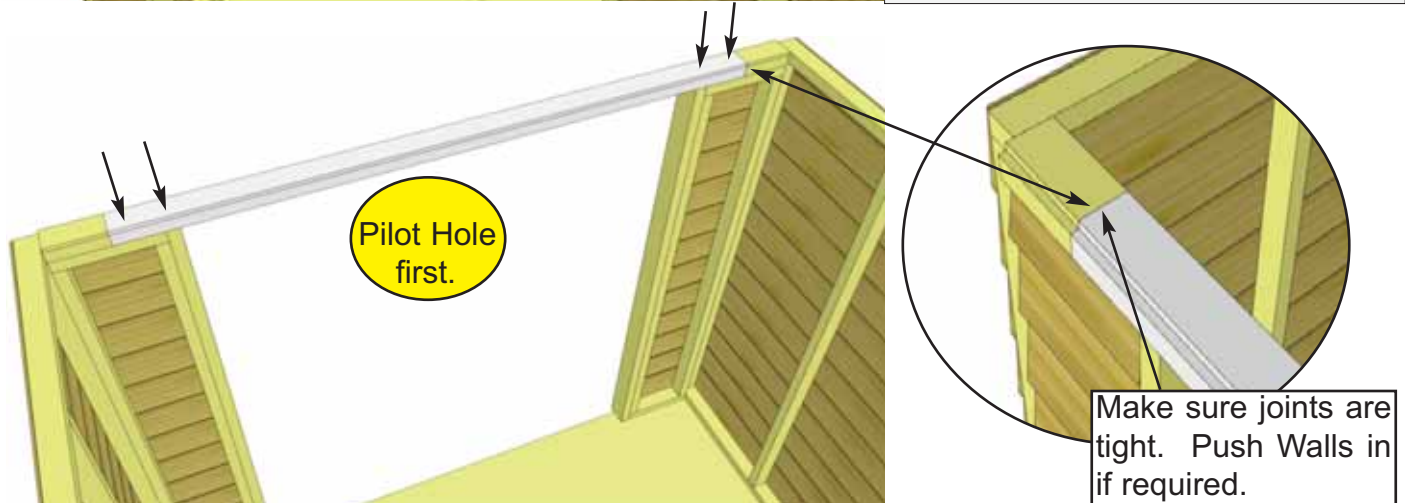

Advice: Prior to fastening walls and installing rafters, take time to confirm your walls are level, square and plumb.

Measure diagonal at top and bottom of walls corner-to-corner. This should be approximately 159 7/8". More importantly, if measurements are not within 1/4", your walls are not square. Adjusting now will make it easier to install roof section.

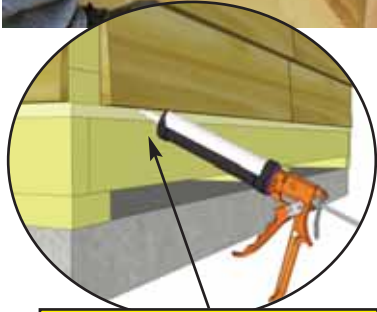

Optional - Caulking seams will help prevent moisture from entering your shed. **Caulking not included in kit.**

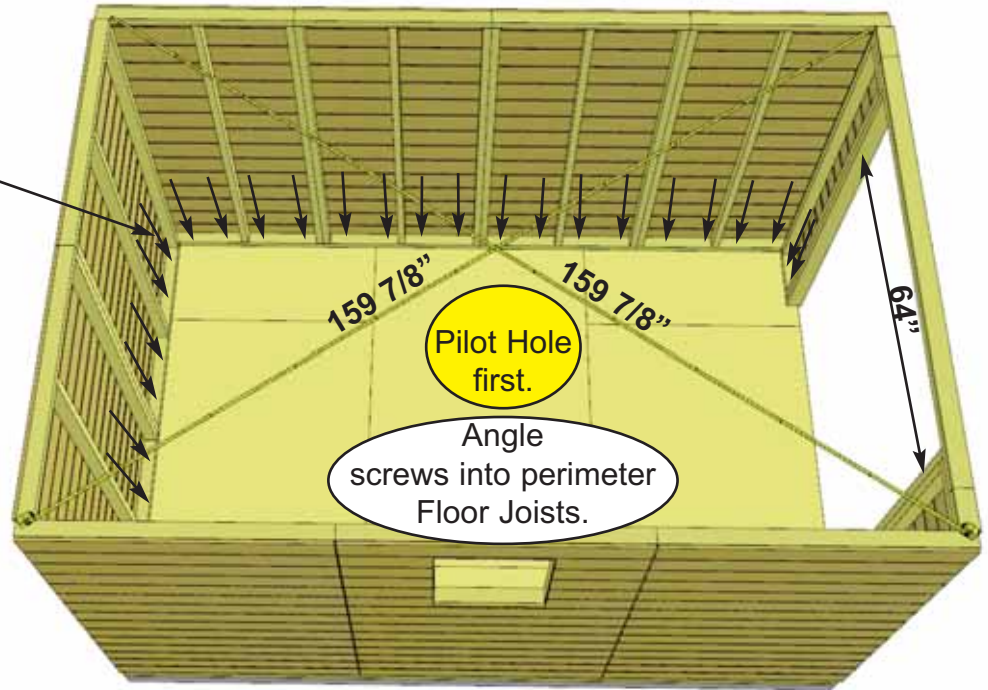

23. When all walls are attached together, check alignment with the floor. Bottom of wall frames should sit flush with outside of floor framing, with siding overhanging by approximately 5/8". Confirm 64" wide door opening at bottom. When positioned correctly, fasten Bottom Wall Plates to floor using **4 - 2 1/2" Screws** per wall panel.

Hardware
S1 - 2 1/2" Screws
x 40 total

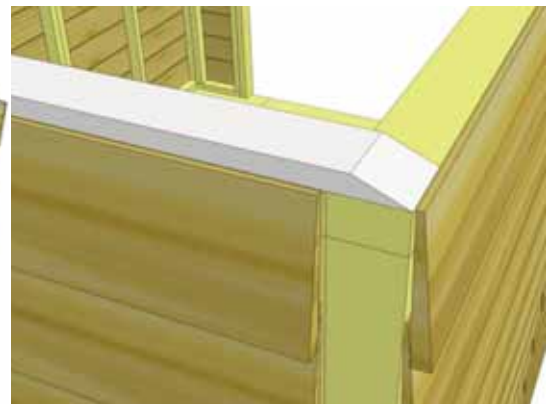
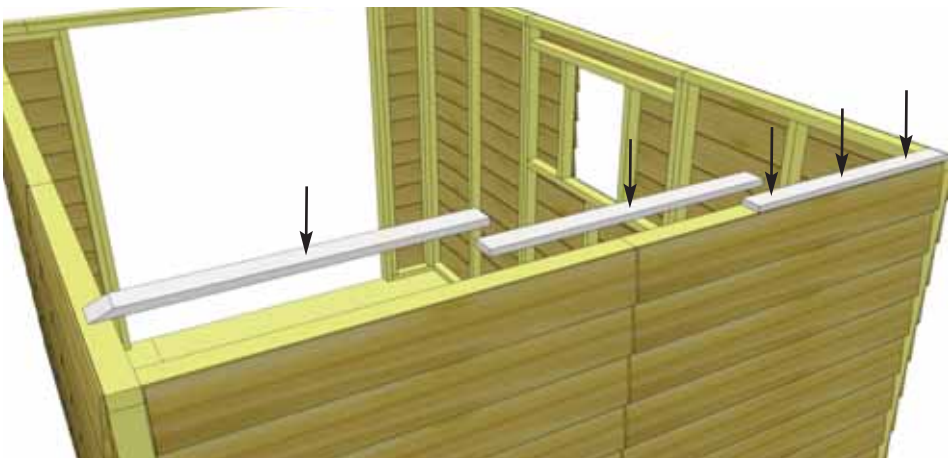

24. Position **Rear Top Plates** on top of wall studs so they are flush on the inside. Together, the plates should be centered evenly on the wall left to right. Attach by screwing down into top wall framing with **3 - 2" Screws** per plate.

Parts (Steps 24 - 25)

Front & Rear Wall Top Plates - 4 *Angle Cut End*, 2 *Straight Cut*
(3/4" x 2 1/2" x 32") x 6

Side Wall Top Plates - *Angle Cut Edge*
(3/4" x 2 1/2" x 65 3/4") x 4

Hardware (Steps 24 - 25)

S3 - 2" Screws
x 34 total

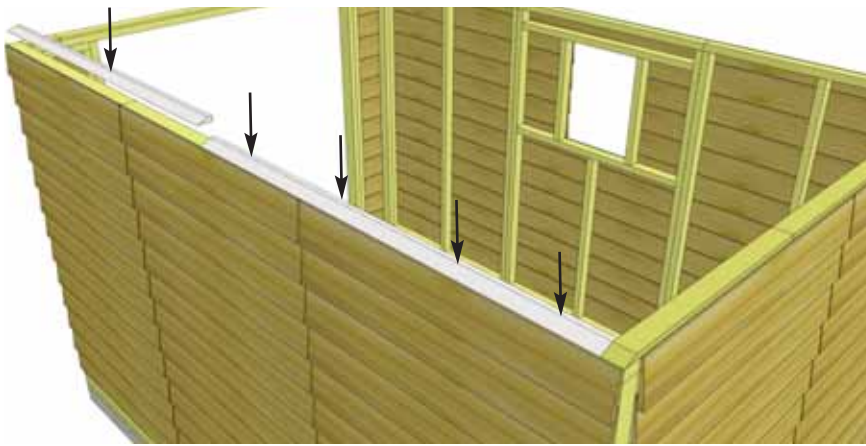

25. Next, attach the **Side Wall Top Plates**. The Side Wall Top Plates are angle cut down the length. Once again, position Top Plates on wall frame so they are flush. Side Wall Top Plates will fit between Front & Rear Plates. Attach with **4 - 2" Screws** per plate. Complete all other **Side & Front Top Plate** attachments the same.

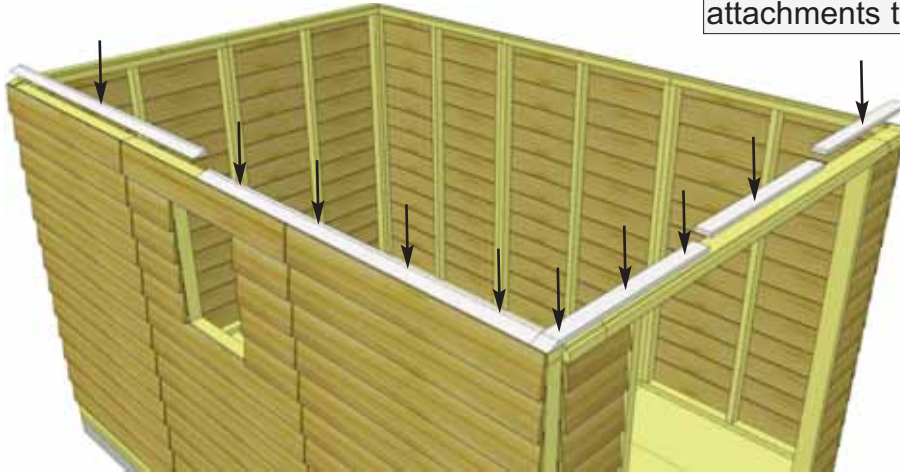

Male / Female Gable Siding Overlap.

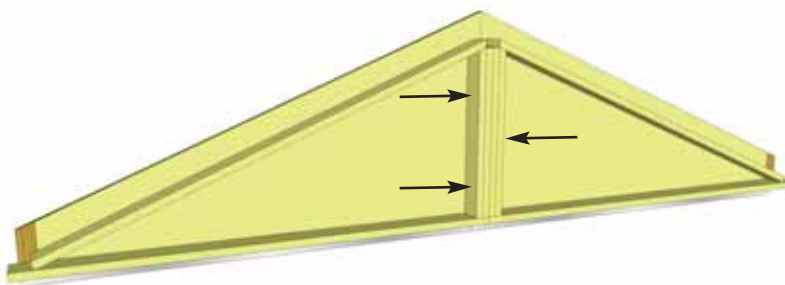
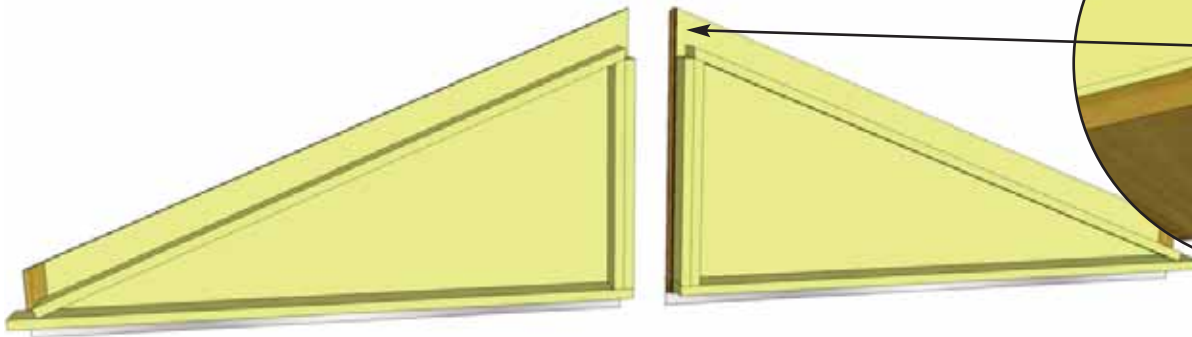
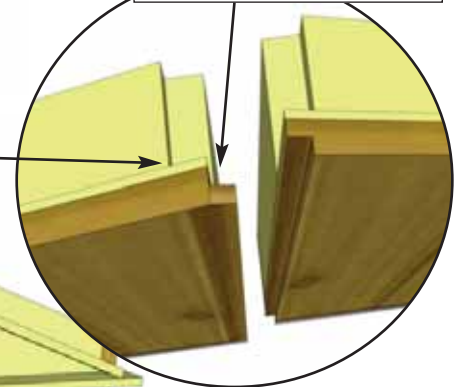

26. Locate **Triangular Gable Half Walls** for both ends of the shed. Align framing and wall siding lap together. Screw center wall framing of each piece together with **3 - 2 1/2" Screws**. **Note:** Prior to attaching, try each combination of Gables for best fit.

Parts

Triangular Gable Half Walls x 4

Hardware

S1 - 2 1/2" Screws x 6 total



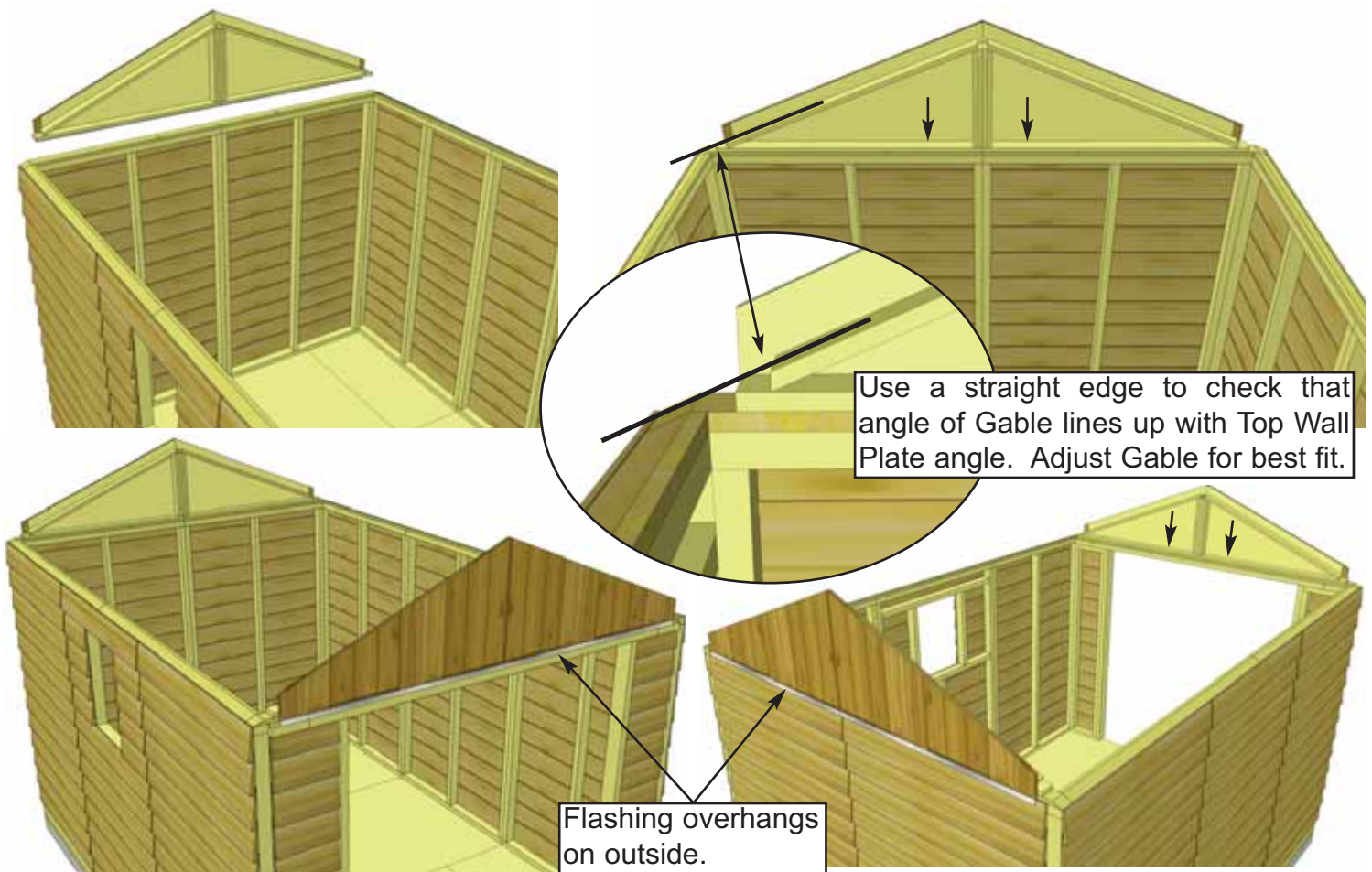

27. Place completed Gable section so framing sits flush with the inside of the Top Wall Plate. It should also be centered side-to-side on the Top Wall Plate. Gable Flashing overhangs wall on the outside. Temporarily attach to Gables and Top Wall Plate with **2 - 2" Screws**. Gables may need slight adjustment in **Step 37** when attachment will be completed with an additional 6 Screws. Screw from the bottom of Gable framing down into Top Wall Plate and Wall Framing. Complete Gable positioning and attachment on the other side.

Hint: Use a straight edge to check the angle of the Gable framing and Top Plate. Both angles should line up (see diagram above).

Hardware

S3 - 2" Screws x 4 total

C. Rafter and Roof Section

Exploded view of all parts necessary to complete the Roof Section. Identify all parts prior to starting.

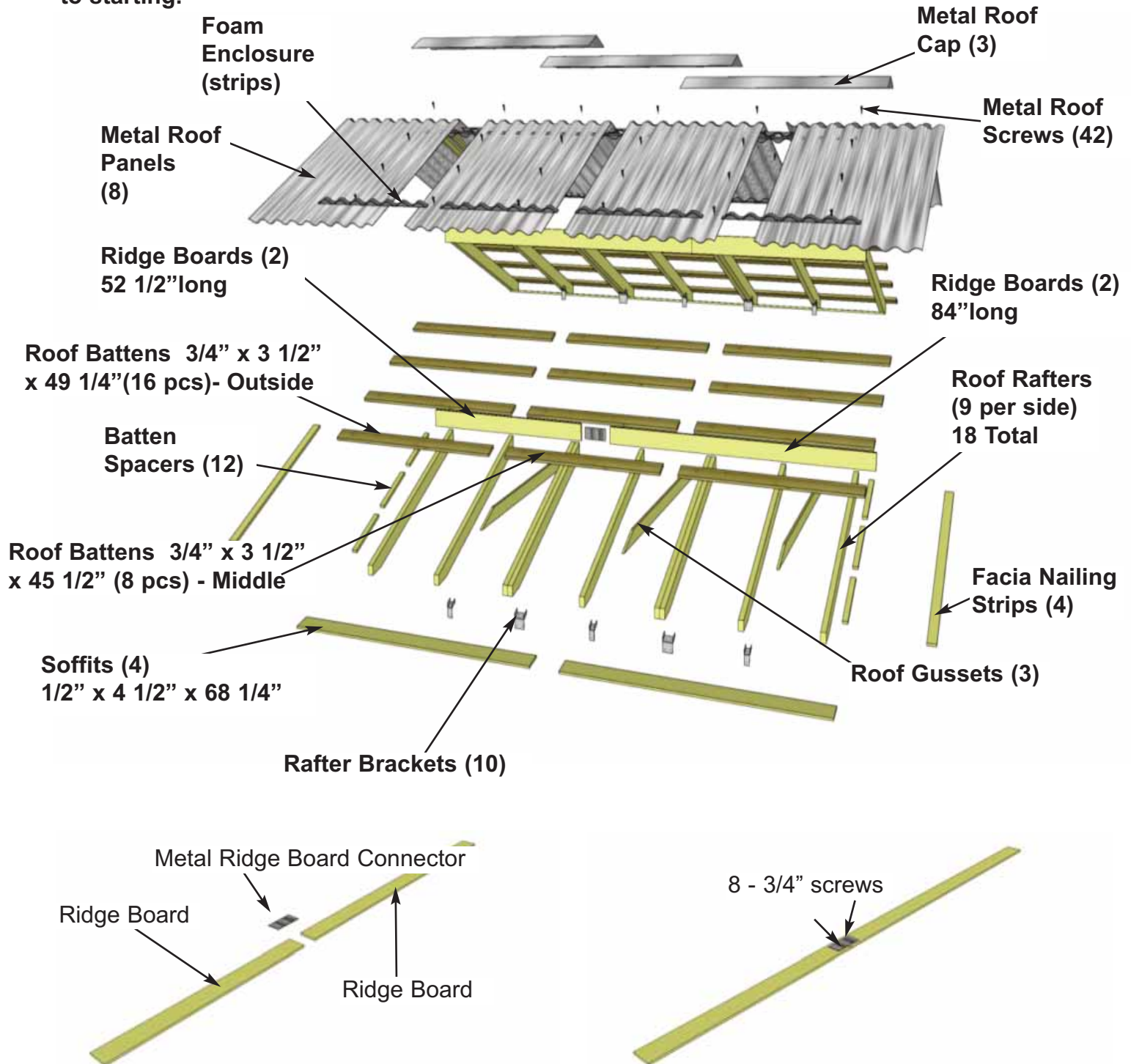

28. Locate (1 each) **Long & Short Ridge Boards** and attach together with a metal **Ridge Board Connector** using **8 - 3/4" Screws**. Total Length when connected is 136 1/2". Connect other set of Ridge Boards the same. Position metal Ridge Board Connector evenly on Ridge Boards.

Parts
Ridge Boards - Long (3/4" x 4 1/2" x 84") x 2
Ridge Boards - Short (3/4" x 4 1/2" x 52 1/2") x 2

Hardware
SS2 - 3/4" Screws x 16 total
Y9 - Ridge Board Connector x 2 total

29. Locate 9 **Rafters**, 2 **Soffits** and a completed Ridge Board. Lay out on level ground as shown to the right. Double up Rafters as illustrated. Screw doubled up Rafters together with **3 - 2 1/2" Screws** per piece.

Parts (Steps 29 - 31)	Hardware (Steps 29 - 31)
Rafters (1 1/2" x 3 1/2" x 56 1/2") x 18	S1 - 2 1/2" Screws x 12 total
Soffits (1/2" x 4 1/2" x 68 1/4") x 4	S2 - 1 1/4" Screws x 28 total
	S3 - 2" Screws x 28 total

Doubled up Rafters - screw together with 3 - 2 1/2" Screws.

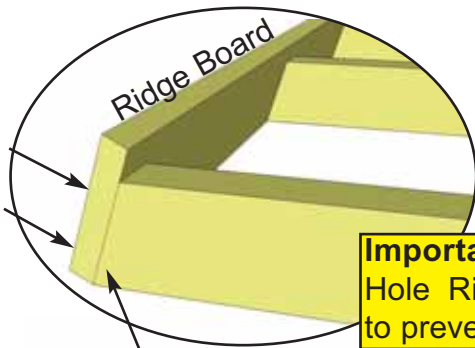
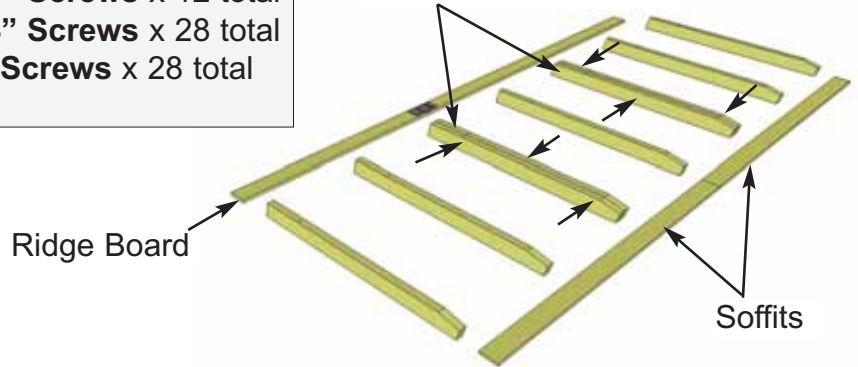

30. Attach completed Ridge Board to ends of both outside Rafters with **2 - 2" Screws** per end. Measure and position interior Rafters as illustrated below. When positioned correctly, attach Ridge Board to remaining Rafters with **2 - 2" Screws** / Rafter end.

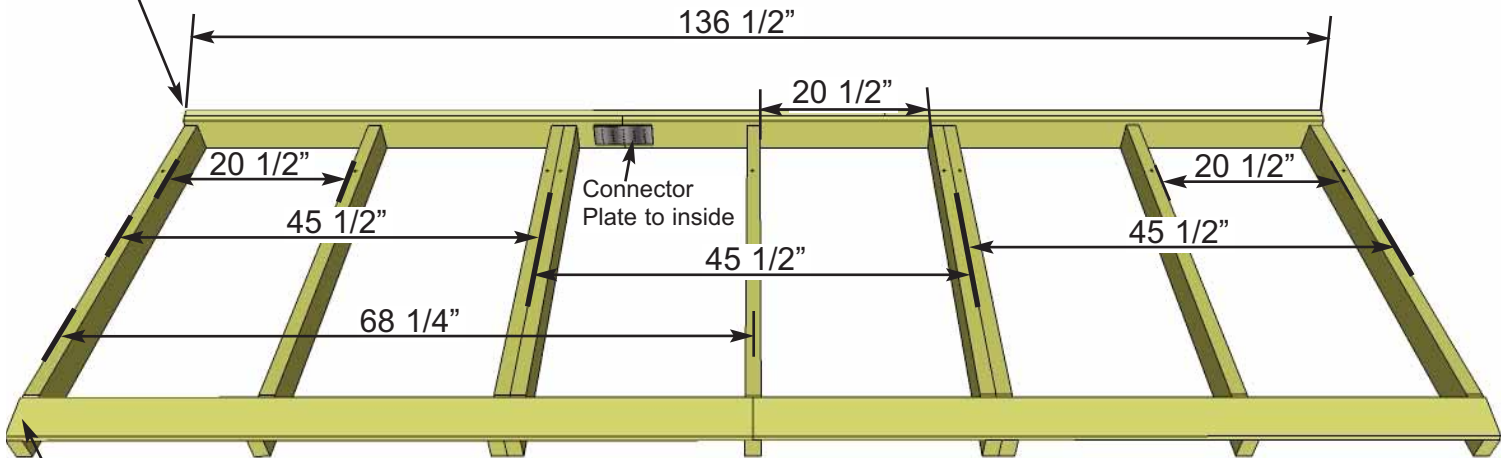

Important: Pilot Hole Soffit to prevent splitting!

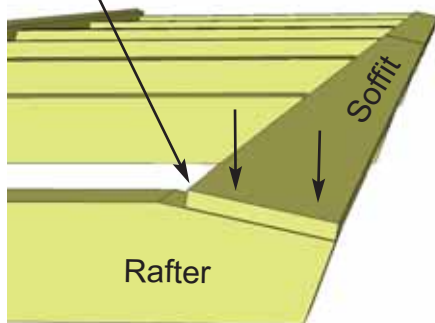

31. Attach end of a Soffit flush to ends of outside rafters with **2 - 1 1/4" Screws** per Rafter end. Drill pilot holes in Soffit to prevent splitting. Complete both outside Rafter / Soffit connections first. Measure and position interior Rafters as illustrated above. When positioned correctly, attach Soffit to remaining Rafters with **2 - 1 1/4" Screws** per Rafter. Flip completed rafter section over. Complete 2nd Rafter section now as per the 1st, but with the following exception - **When attaching Ridge Board to Rafter ends, make sure Metal Ridge Board Connector is positioned so offset to first Rafter Section. See Step 36 for illustration.**

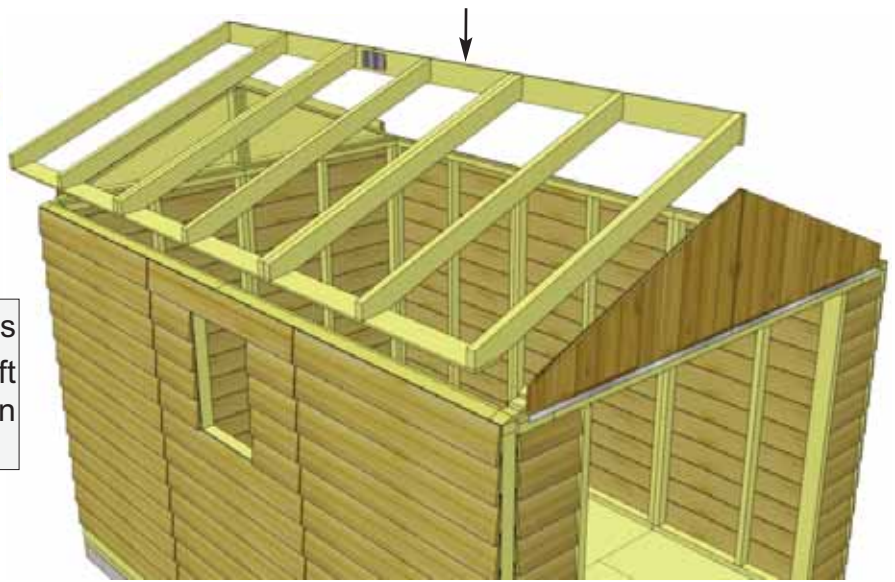
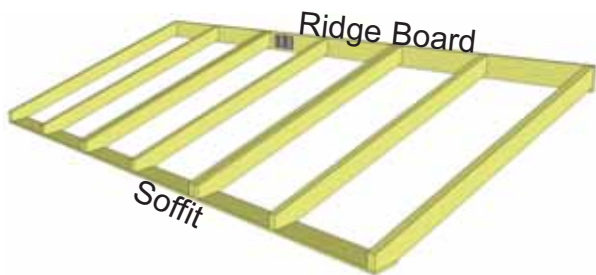

32. Flip Rafter Section over so Soffit is facing down. Starting with one side, lift completed Rafter Section up and place on gable framing.

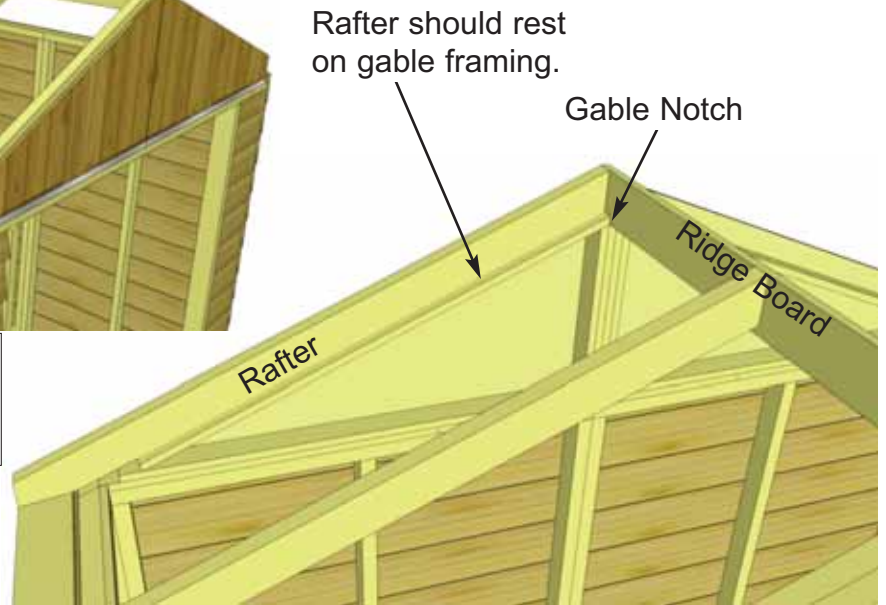
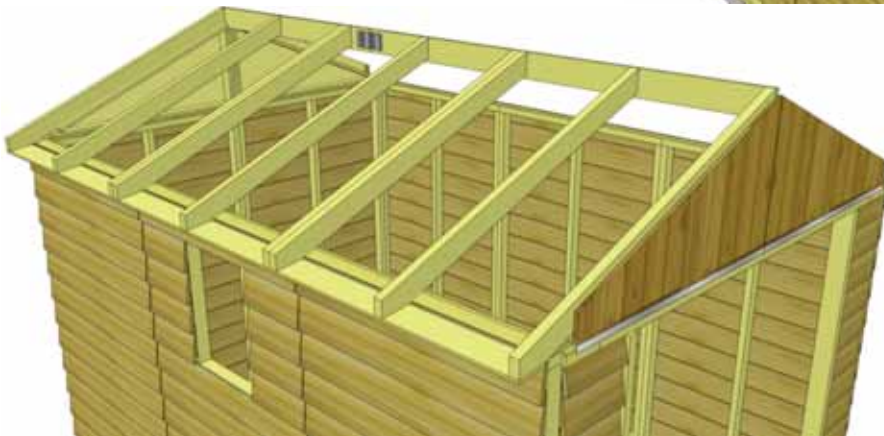

33. Slide Rafter Section up on gable framing until bottom of Ridge Board slips into gable notch.

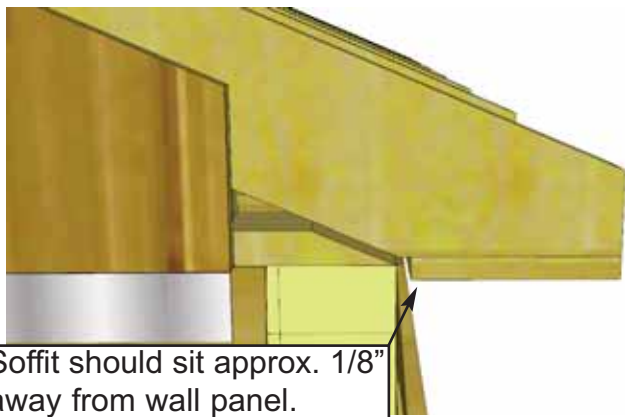

Soffit should sit approx. 1/8" away from wall panel.



34. When Rafter Section is correctly positioned, outside rafters will sit equally on gable framing and Soffit will sit approximately 1/8" away from wall panels.

35. Place second completed Rafter Section on gable walls as per **Steps 32 - 34.**

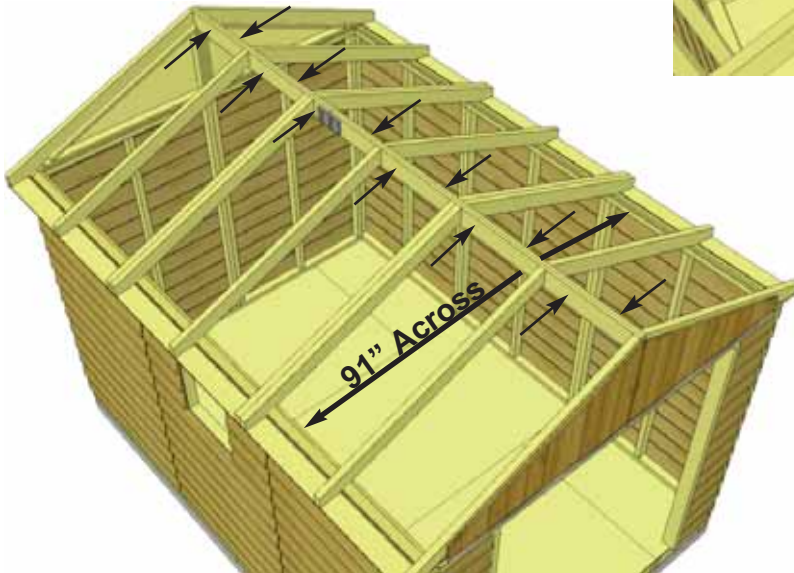
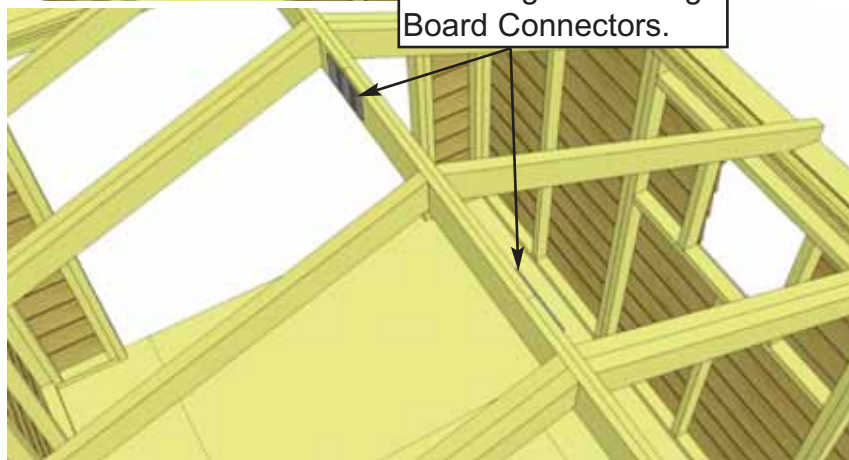
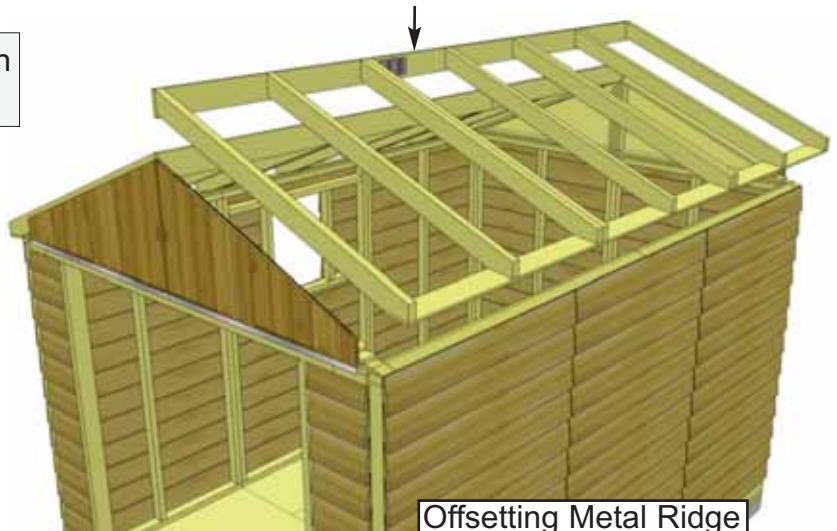
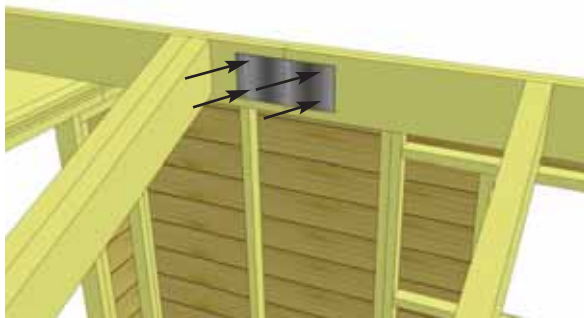
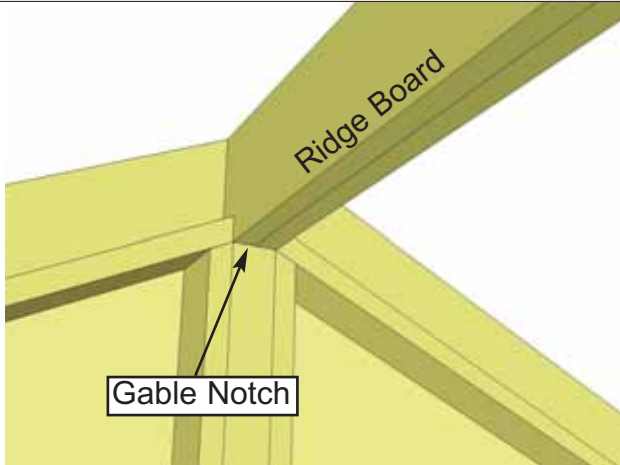

36. At the peak, align Ridge Boards so they are flush together and secure them with **12 - 1 1/4" Screws.**

Important: If there is a gap between Ridge Boards, have a helper push the Side Walls closer together from outside. Walls should be 91" apart at top from inside of wall plate to opposite wall plate. To completely secure Ridge Boards, place **1 1/4" Screws** into any of the remaining metal Ridge Board Connector holes. Complete both sides.

Hardware

S2 - 1 1/4" Screws x 20 total (approx.)

37. With both Ridge Boards connected, completely secure rear Gable framing to walls and rafters. Use **4 - 2" Screws** per Rafter. Use an additional **6 - 2" Screws** to secure Gable to wall.

Note: you may have to remove the 2 temporary screws in Gable from Step 27 and reposition Gable for best fit prior to completing Gable attachment.

Hardware

S3 - 2" Screws x 14 total

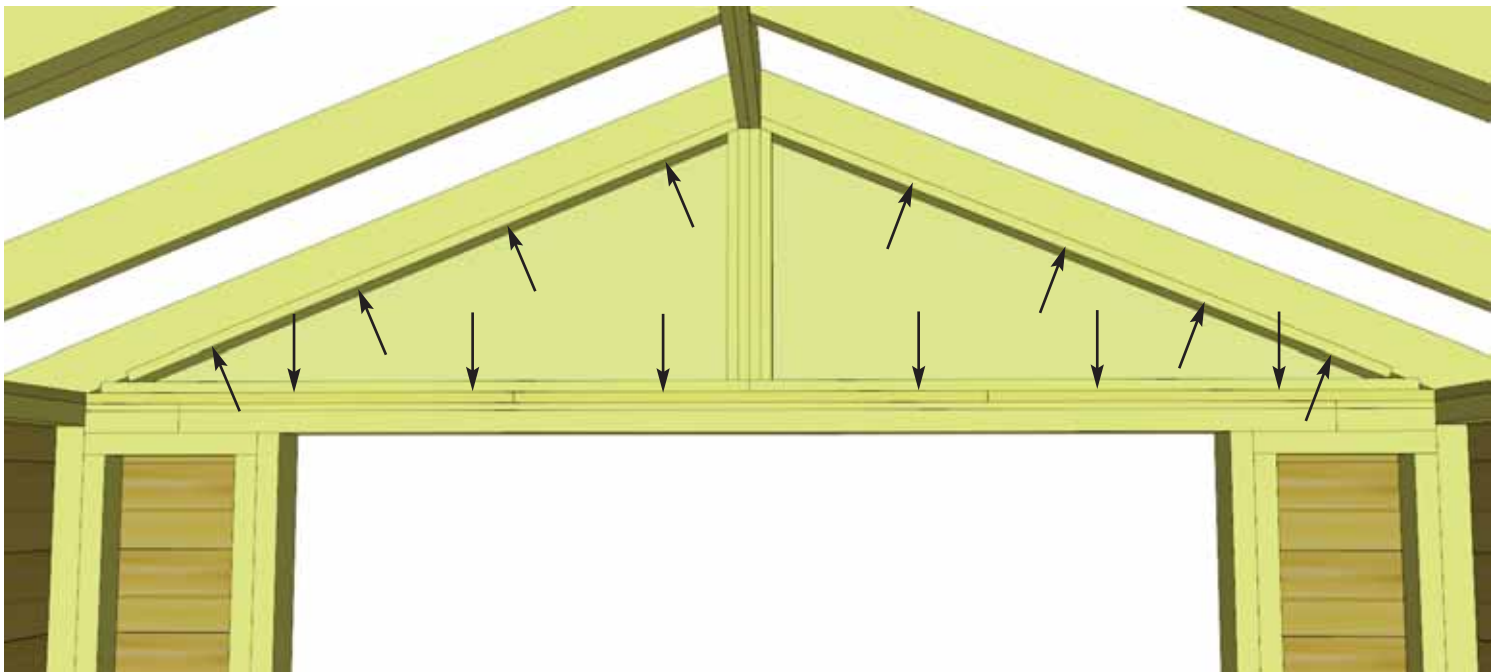
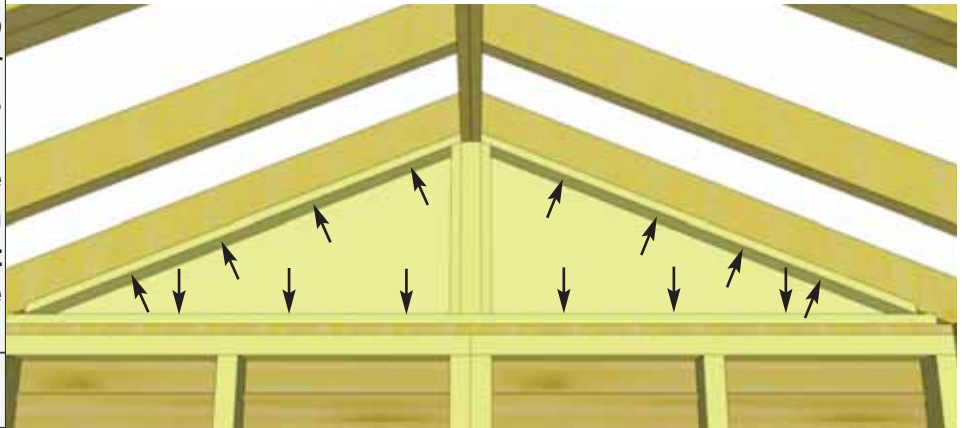

38. With both Ridge Boards connected, completely secure front Gable framing to walls and rafters. Use **4 - 2" Screws** per Rafter. Use an additional **6 - 2" Screws** to secure Gable to wall.

Note: you may have to remove the 2 temporary screws in Gable from Step 27 and reposition Gable for best fit prior to completing Gable attachment.

Hardware

S3 - 2" Screws x 14 total

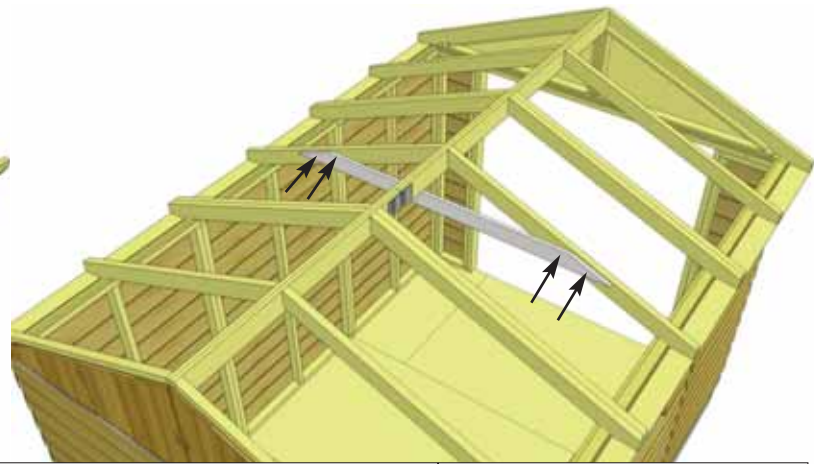
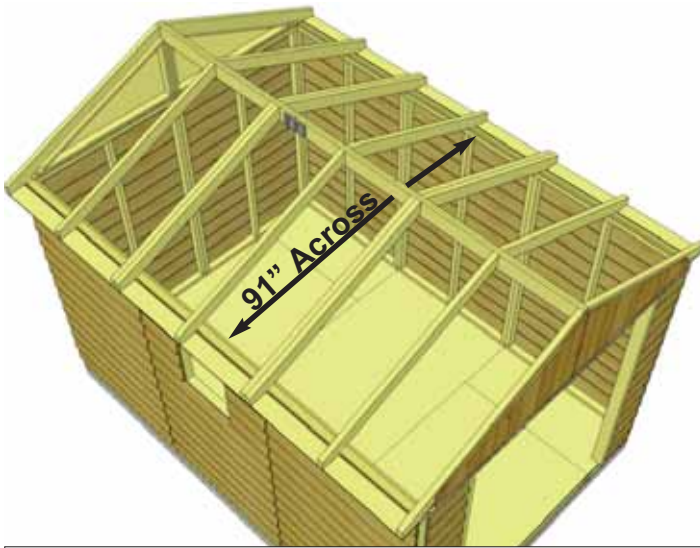

39. Roof Gussets are positioned on mid rafters. Have two helpers push the Side Walls at the top from the outside of shed until inside to inside measurement between the Top Plates is 91". Slide Gusset up on side of Rafters. Gusset must be below top edge of rafter. Use level to square Gusset and attach to Rafters with **4 - 2" Screws**. Pilot hole each Gusset end with 1/8" drill bit.

<u>Parts</u>
Roof Gussets (3/4" x 3 1/2" x 72") x 3
<u>Hardware</u>
S3 - 2" Screws x 12 total

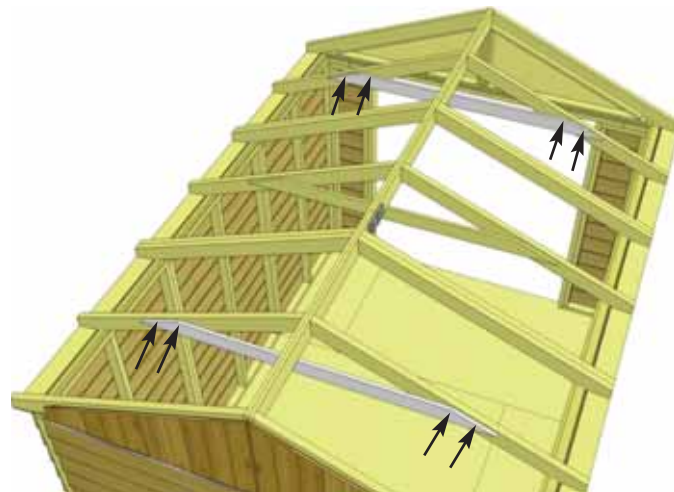

40. Complete remaining 2 Gussets as per **Step 39**.

41. Attach all Single and Double Rafter Brackets where rafters meet Top Wall Plates inside of shed. Attach with **2 - 1 1/4" Screws** and **2 - 2" Screws** per **Single Rafter Bracket** and **6 - 2" Screws** per **Double Rafter Bracket**.

Have two helpers hold the Side Walls at the top from the outside of shed to keep the inside-to-inside measurement between the Top Plates at 91".

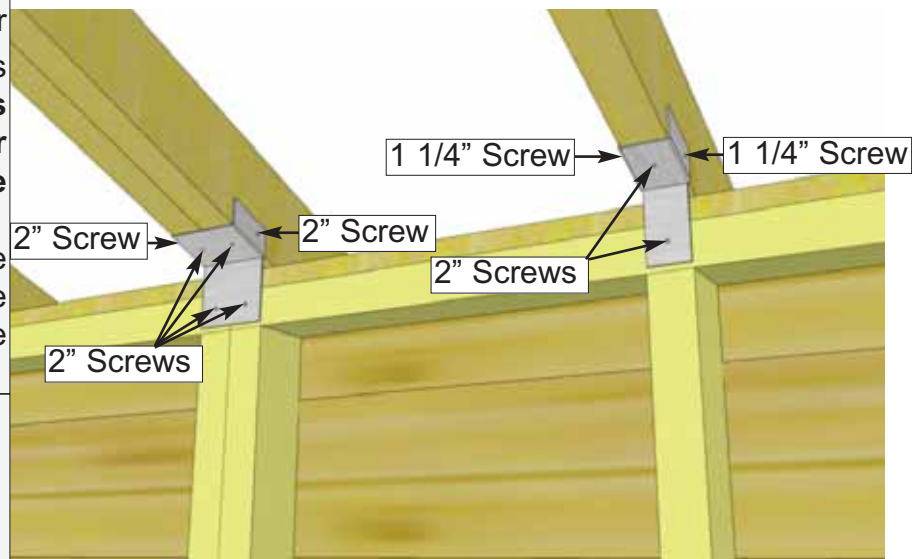

<u>Hardware</u>
Y30 - Single Rafter Brackets x 6 total
Y31 - Double Rafter Brackets x 4 total
S2 - 1 1/4" Screws x 12 total
S3 - 2" Screws x 36 total

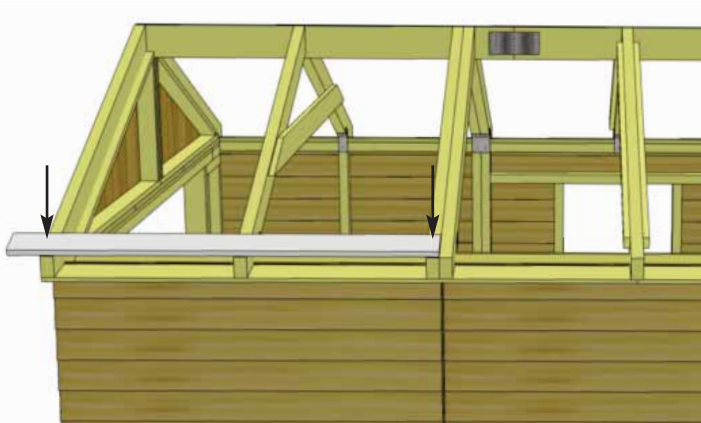

42. Locate first row of **Roof Battens**. Starting with an **Outside Batten** place on **Rafters** 1/8" up from **Rafter** end. **Batten** should rest on center of double rafter. Pre-drill 1/8" pilot hole before attaching. Attach with **2 - 1 1/4"** screws. Next place **Middle Batten** between double rafters and attach with **2 - 1 1/4"** screws. Next attach 2nd **Outside Batten** with **2 - 1 1/4"** screws.

Parts (Steps 42 - 46)
Roof Batten Outside (3/4" x 3 1/2" x 49 1/4") x 16
Roof Batten Middle (3/4" x 3 1/2" x 45 1/2") x 8
Batten Spacers (3/4" x 1 1/2" x 14 1/8") x 12

Hardware (Steps 42 - 46)
S2 - 1 1/4" Screws
 x40 total

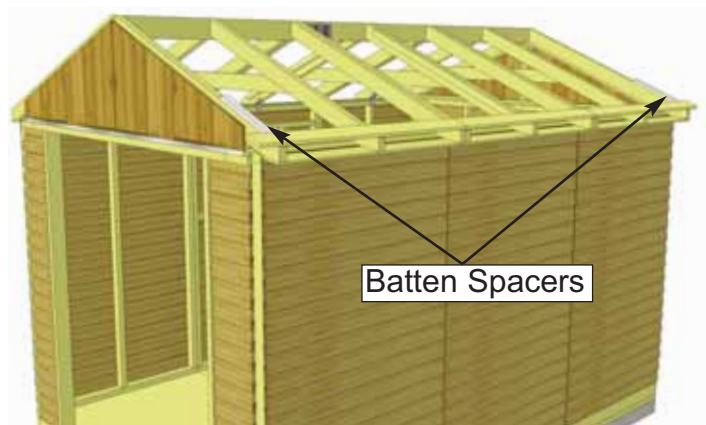
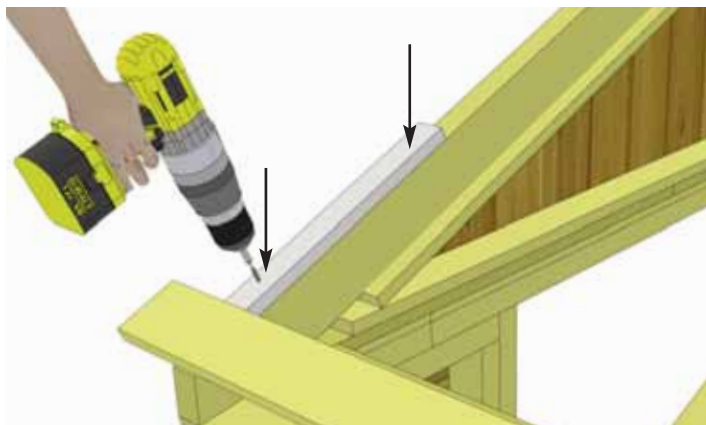

43. Locate **Batten Spacers**. Place 1 **Batten Spacer** above **Outside Battens** lengthwise along outside Rafter. Attach each Batten Spacer to outside Rafter with **2 - 1 1/4"** screws (4 total)

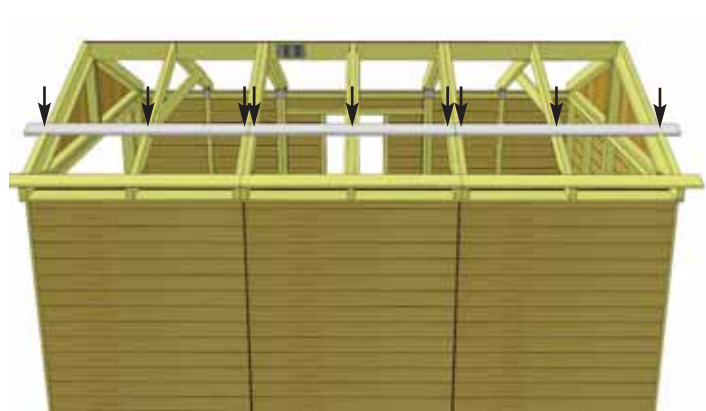

44. Locate 2nd row of **Roof Battens**. Place Batten flush against Batten Spacers. Ends of Batten should line up as the 1st row did in **Step 42**. Attach each Batten as per **Step 42**.



45. Repeat **Steps 42 - 44** to complete remaining 2 rows of **Roof Battens**. Place **Batten Spacers** between each row.

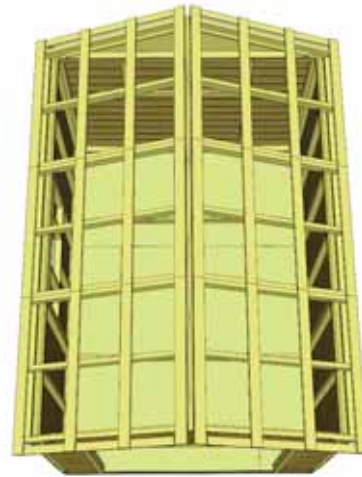
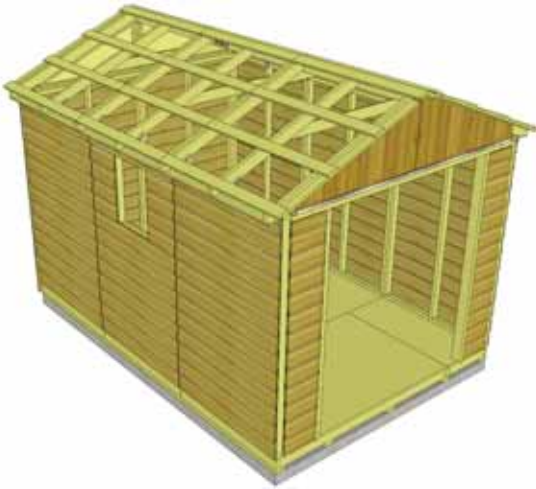

46. Complete attachment of **Battens** to 2nd Rafter section as per **Steps 42-45**.

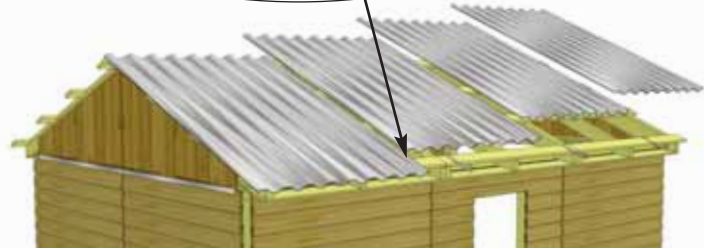
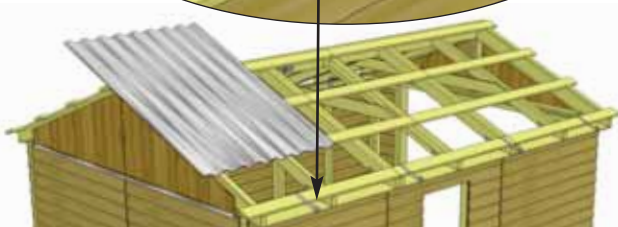
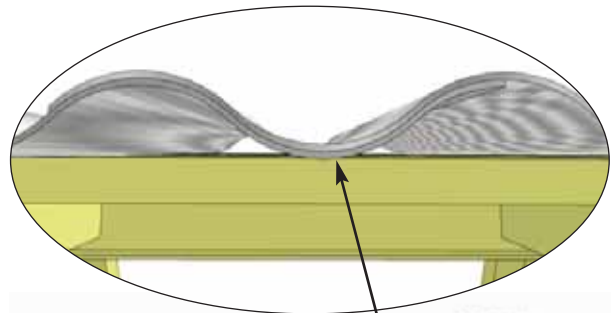
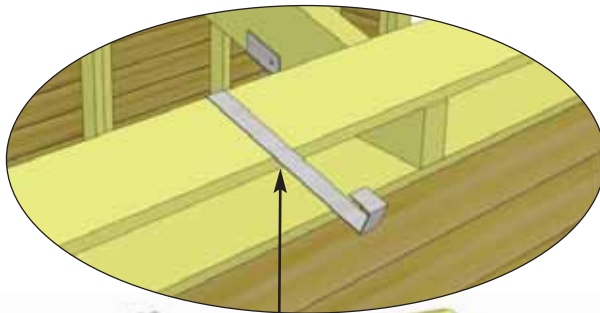

47. Locate 4 **Metal Roof Panels** and 4 **Metal Roof Hangers**. To temporarily hold the Metal Roof Panels in place, hook a Metal Roof hanger onto the lowest Batten, approximately where the center of the panels will be. Place first Metal Roof Panel onto Battens and into Metal Roof Hanger. Do not fasten panels down until **Step 53**. Place remaining 3 panels and hangers on the same way. Metal Roof Panels will overlap each other.

Parts (Steps 47 - 59)

Metal Roof Panels

(39" wide x 58"long) x 8

Metal Ridge Caps

(60" long) x 3

Foam Roof Enclosures

(Several Pieces)

Hardware (Steps 47 - 59)

Metal Roof Screw

(3/8"x2") x 36 total

Metal Ridge Cap

Screws

(5/16" x 7/8") x 12 total

Silicone Caulking

(1 Tube)



48. Do not attach **Metal Roof Panel** onto **Rafters** until all panels are positioned and spaced. **Metal Roof Panel** should overhang on the side by approximately 3/4". In the meantime, have your helper hold the panel in place so it doesn't slide off. Locate 2nd roof panel.

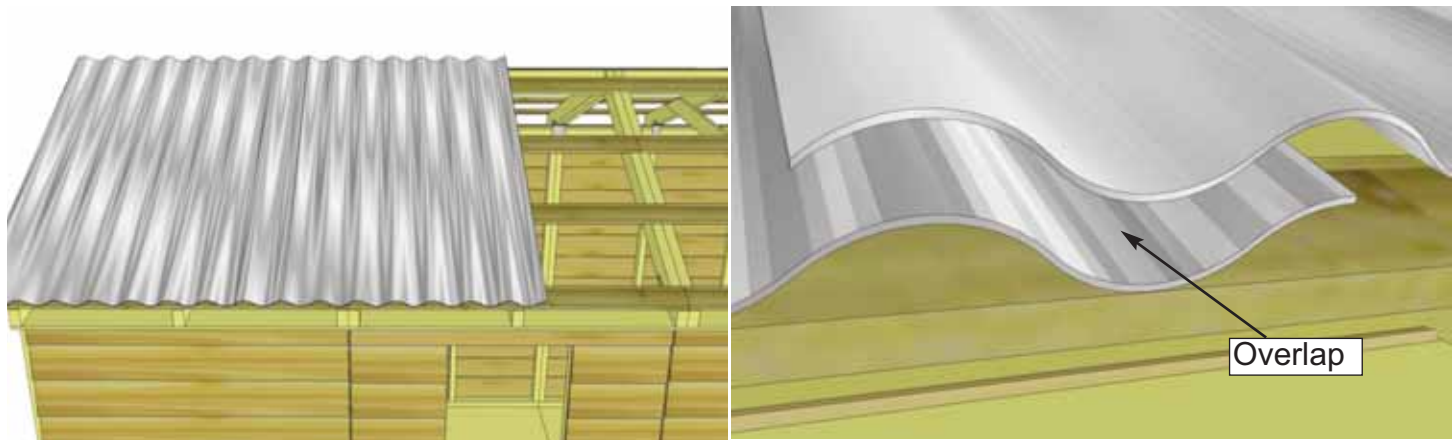

49. Place 2nd **Metal Roof Panel** on **Rafters** and overlap panel with the first outside panel as shown above. Temporarily position panel at top and bottom as per first panel.



50. Place remaining 3rd and 4th **Metal Roof Panels** on **Rafters** as per **Steps 48-49**. Overlap **Metal Roof Panels** to achieve desired width.



51. Once **Metal Roof Panels** are spaced correctly from side-to-side and top-to-bottom, lift panels up and run a bead of caulking down the overlapping seams of each pane to seal the joints.

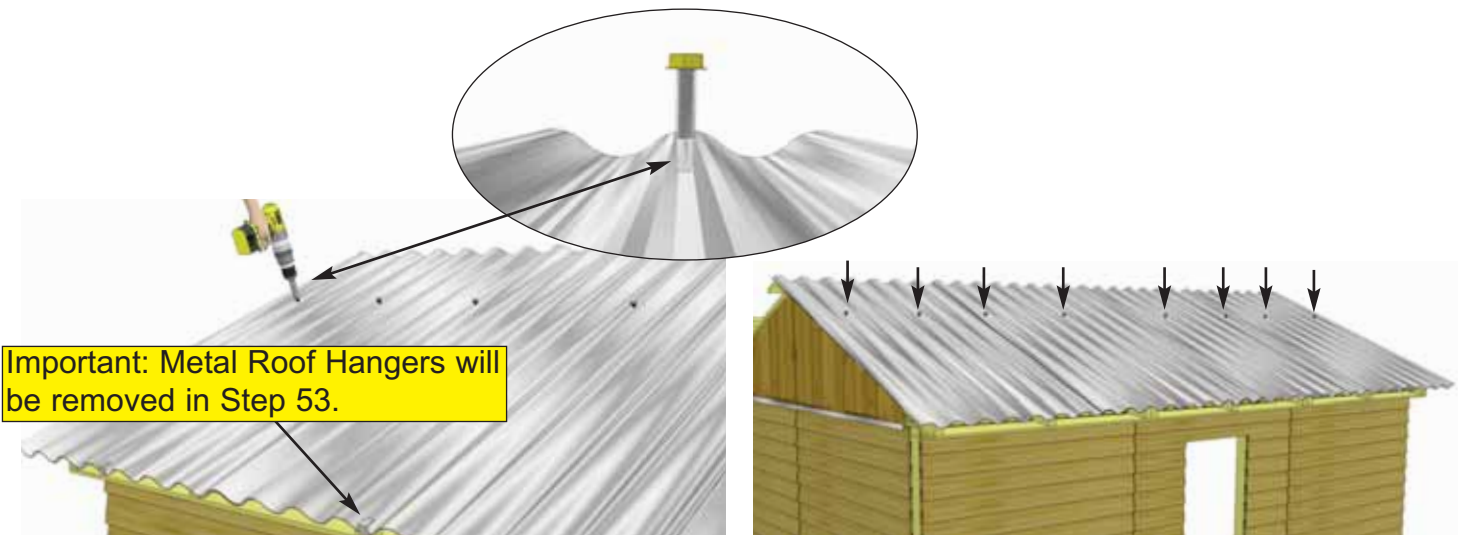

52. Using **8 - 2" Metal Screws** and **1/4" Nut Driver** (included), partially secure Metal Roof Panels to 2nd row of battens from top. Only fasten screws halfway so that Metal Roof Hangers can be removed. Metal screw is self-tapping, screw into center of Battens at peak of Roof panels.



53. Before fully securing roof panels, remove Metal Roof Hangers from Roof.



54. Before attaching roof panels down, insert **Foam Enclosures** between **Metal Roof Panels** and **Battens**.

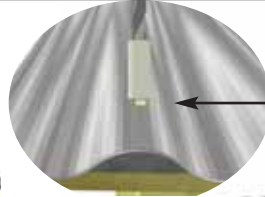
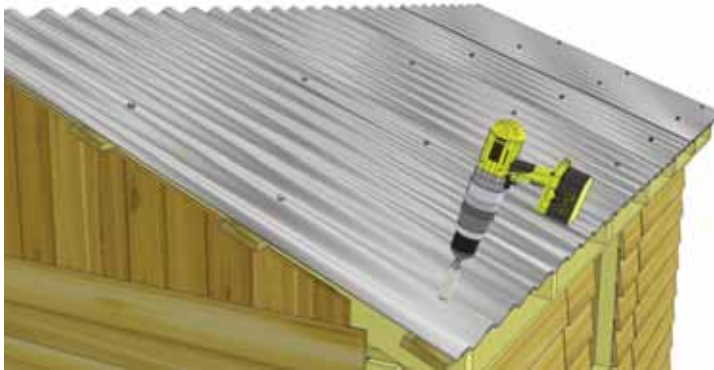

Screw into peak of
Metal Roof Panel



55. Using **2" Metal Screw** and **3/8" Nut Driver** (included), secure outside **Metal Roof Panel** down to each **Batten**. Metal screw is self-tapping. do not overtighten! Screw through the peak of the **Metal Roof Panel** not the valley. Use a total of 18 screws to secure **Metal Roof Panels** to lower 3 rows of **Battens**.



56. Complete the opposite metal roof as per **Steps 47-55**.

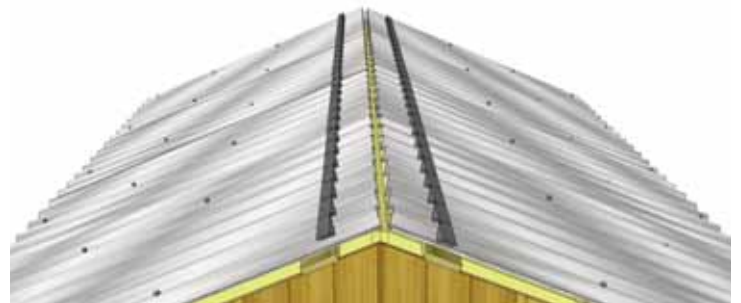

57. Before attaching **Metal Ridge Caps**, place strips of **Foam Enclosures** near to top. **Foam Enclosures** will prevent moisture from coming in from the top. Complete for both sides.

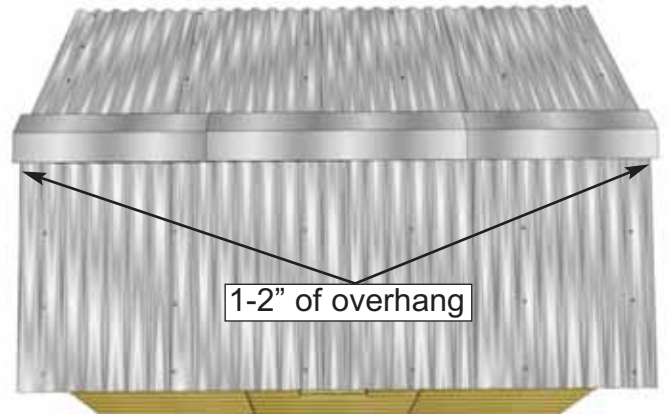

58. Place all three **Metal Ridge Caps** on apex of roof. Evenly space from front to back. **Metal Ridge Caps** will overlap each other. Overhang the cap by approximately 1-2" past each end.

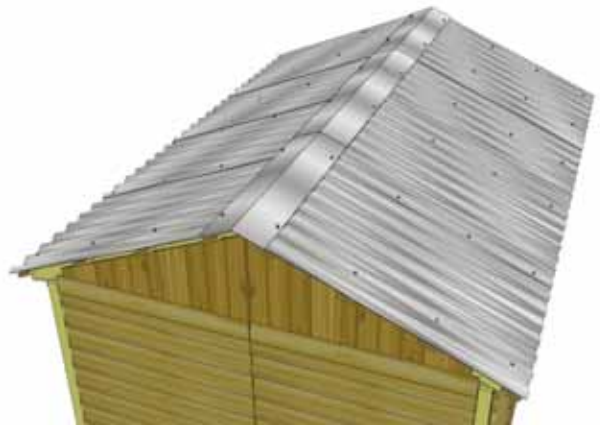

59. When **Metal Ridge Caps** are correctly positioned, secure with 12 - 2" long self-tapping metal screws. Screw into final **Batten** with 1/4" **Nut Driver**. Do not overtighten!



60. Attach **Facia Nailing strips** (3/4" x 2 1/2" x 51") to the underside edge of **Roof Battens** with 4 - 1 1/4" screws per piece. **Nailing Strip** will make it easier to attach Front and Rear Facia in **Step 73**. Complete front and rear strips (4 pieces total).

D. Trim & Miscellaneous Section

Exploded view of all parts necessary to complete the Miscellaneous Section. Identify all parts prior to starting.

Note: Not shown: Rear Gable Trim, Rear Narrow Trim, Rear Gable Detail Plate, Facia Nailing Strips, Interior Door Stops, 1 Interior Cane Bolt

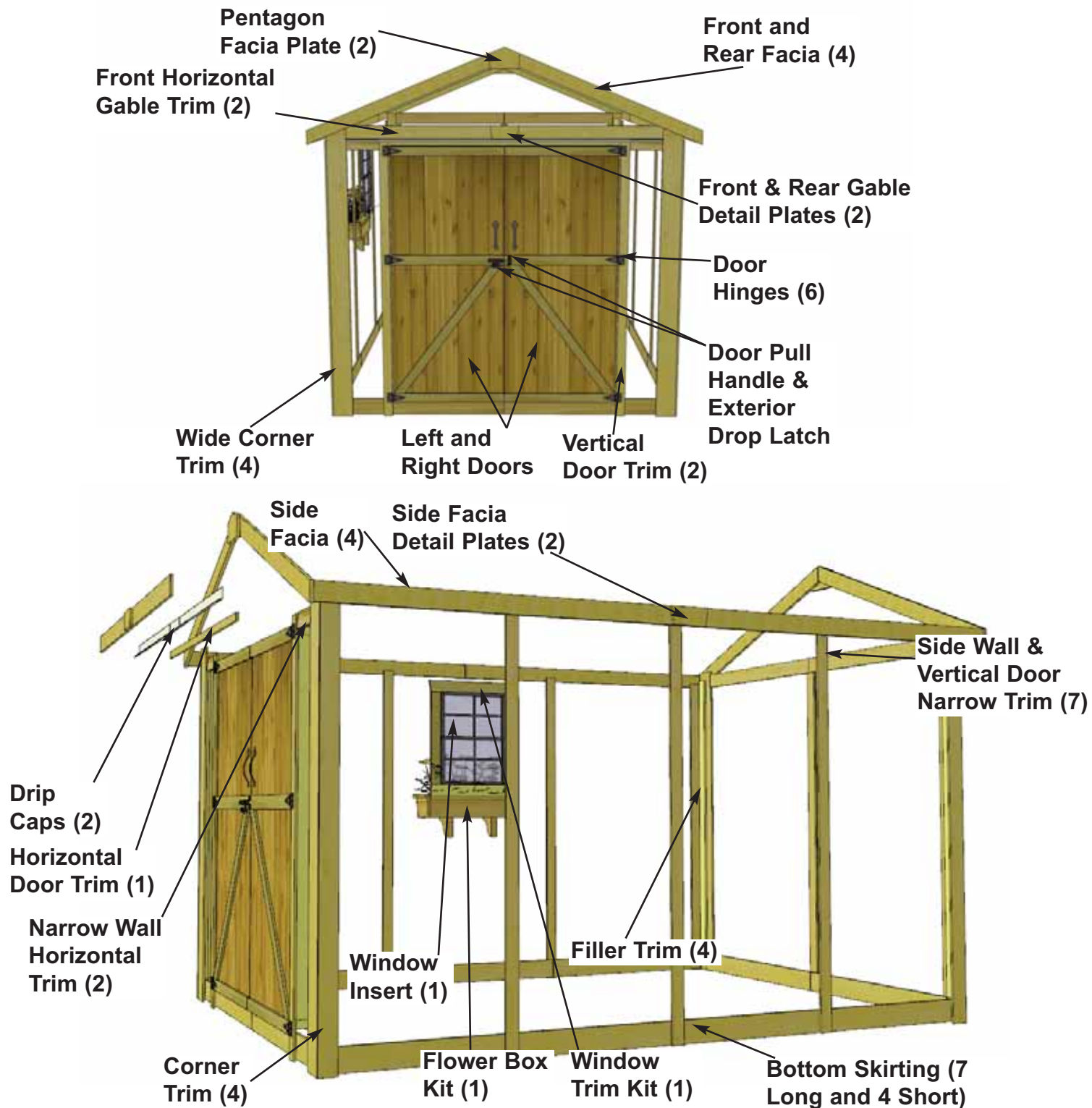

Expert Advice: When installing trim, sort pieces according to color and pieces that are most pleasing to the eye. Start with least visible side of shed and use the least desirable pieces first. Install trim to most visible side of shed as your skill installing trim improves.

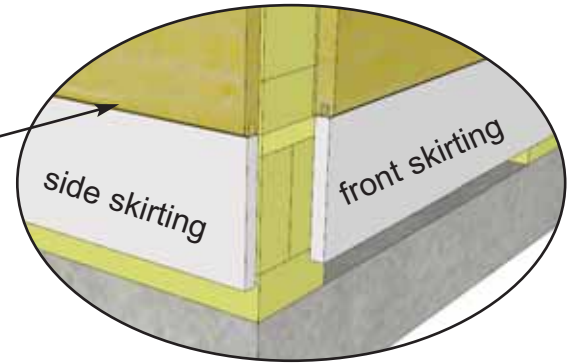

61. Attach **Bottom Skirting Long** and **Bottom Skirting Short** around the base of the shed (**Bottom Skirting Short** goes along the right side wall). Skirting will hide floor framing. Gaps on side will be covered by Wide Trim pieces later. Start with Side Skirting pieces first and attach with **4 - 1 1/2" Finishing Nails** per piece.

<u>Parts</u> Bottom Skirting (1/2" x 4 1/2" x 45 1/4") x 7 Bottom Skirting (1/2" x 4 1/2" x 34 1/8") x 4
--

<u>Hardware</u> N1 - 1 1/2" Finishing Nails x 44 total

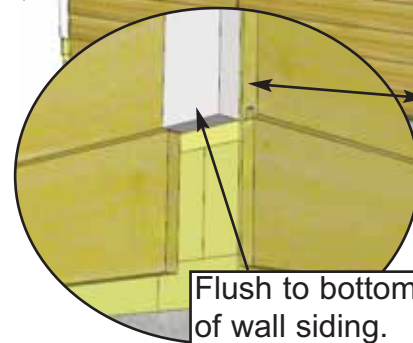
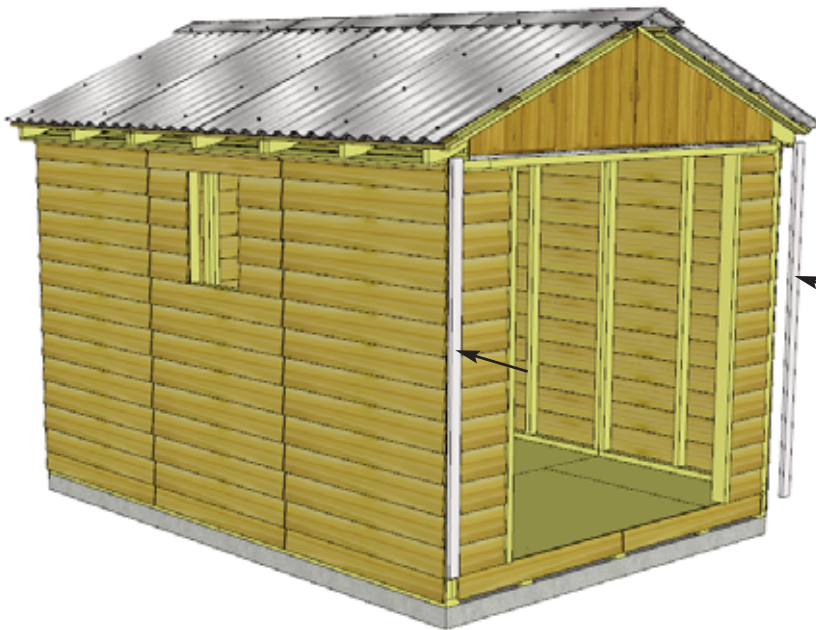

62. Attach **Filler Trim** to each corner side wall. Align Filler Trim so it sits flush with the bottom of the last piece of Wall siding. Attach with **8 - 1 1/2" Finishing Nails** per piece.

<u>Parts</u> Filler Trim (5/8" x 2 1/2" x 75") x 4

<u>Hardware</u> N1 - 1 1/2" Finishing Nails x 32 total

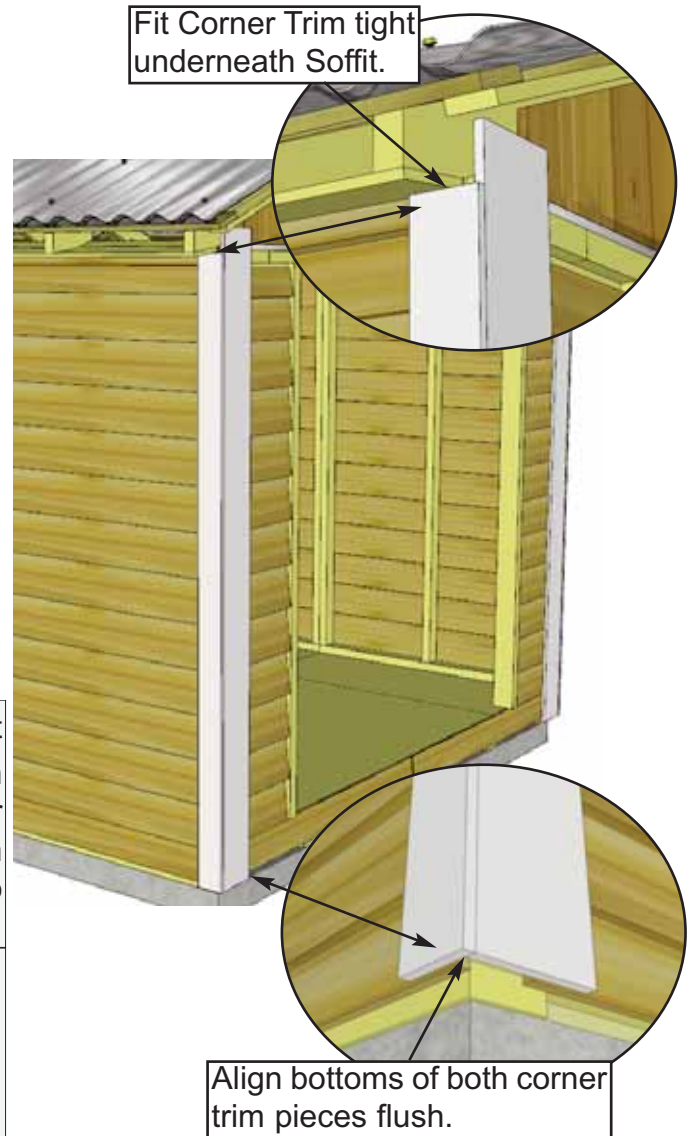

64. To trim out corners, start with a **Corner Trim**, align tight underneath Soffit and Rafter. Align **Wide Corner Trim** with bottom of Corner Trim. Corner Trim will cap the Wide Corner Trim. Do a dry run in each corner before attaching to confirm positioning. Use **8 - 1 1/2" Finishing Nails** per piece to secure. Complete other front corner the same.

Parts (Steps 64 - 65)

Corner Trim

(1/2" x 3 1/2" x 79") x 4

Wide Corner Trim

(1/2" x 5 1/2" x 82") x 4

Hardware (Steps 64 - 65)

N1 - 1 1/2" Finishing Nails

x 64 total

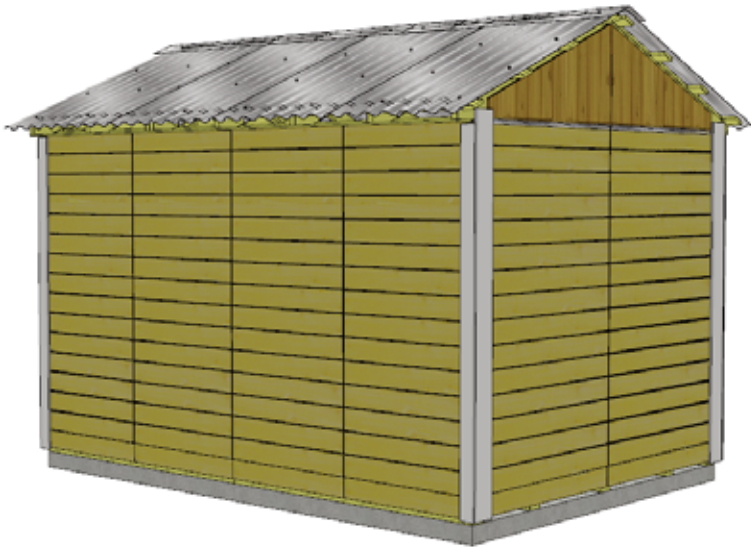

65. Trim out rear corners with remaining pieces of **Corner Trim** and **Wide Corner Trim**. Align and attach with **8 - 1 1/2" Finishing Nails** per piece as per **Step 64**.

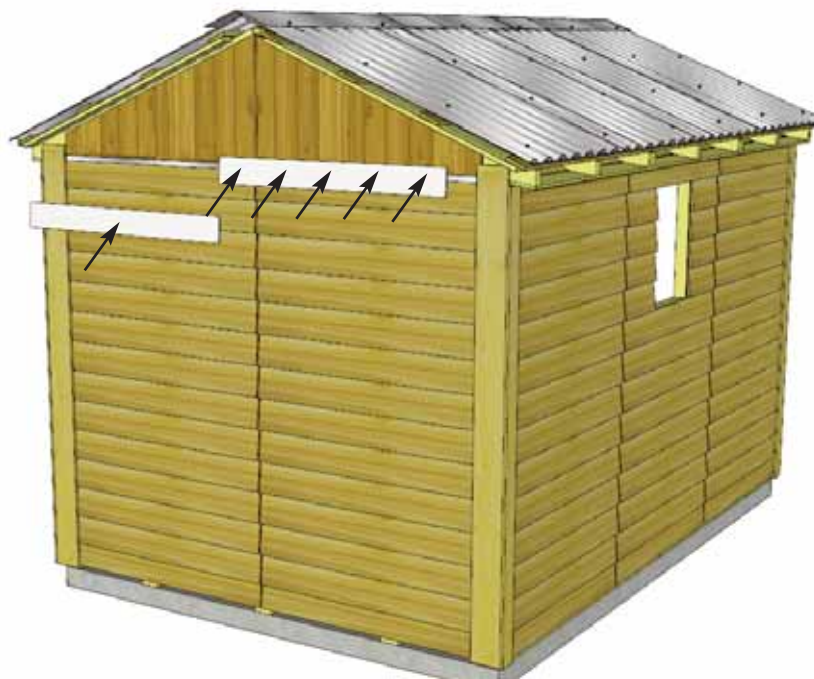

66. Attach **Rear Horizontal Gable Trims** to the back of the shed. Position over gable and wall seam. Use **5 - 1 1/2" Finishing Nails** to secure each piece.

Parts
Rear Horizontal Gable Trim
 (1/2" x 4 1/2" x 43 1/4") x 2

Hardware
N1 - 1 1/2" Finishing Nails x 10 total

67. Position **Drip Caps** so they are overlapping above doorway, resting in the notch of the Door Header. Attach each Drip Cap with **5 - 1 1/2" Finishing Nails** per piece.

<u>Parts</u>
Metal Drip Caps x 2
<u>Hardware</u>
N1 - 1 1/2" Finishing Nails x 10 total

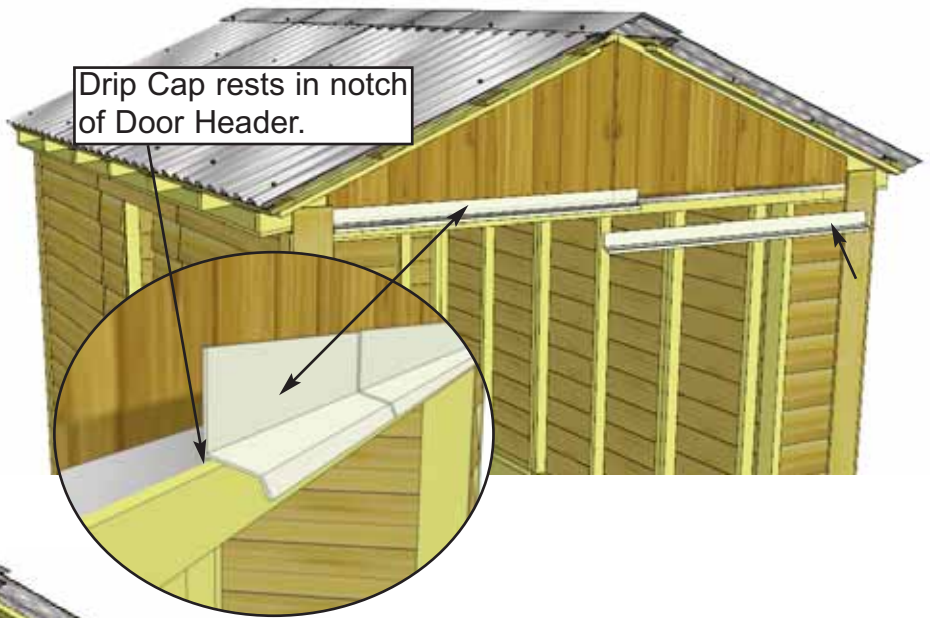

68. With Drip Caps secured place **Front Horizontal Gable Trims** over the Drip Caps and attach each with **2 - 1 1/2" Finishing Nails**.

<u>Parts</u>
Front Horizontal Gable Trim (1/2" x 4 1/2" x 43 1/4") x 2
<u>Hardware</u>
N1 - 1 1/2" Finishing Nails x 4 total

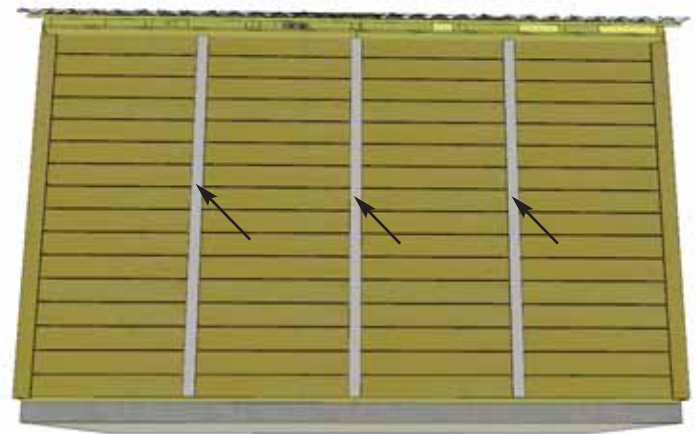
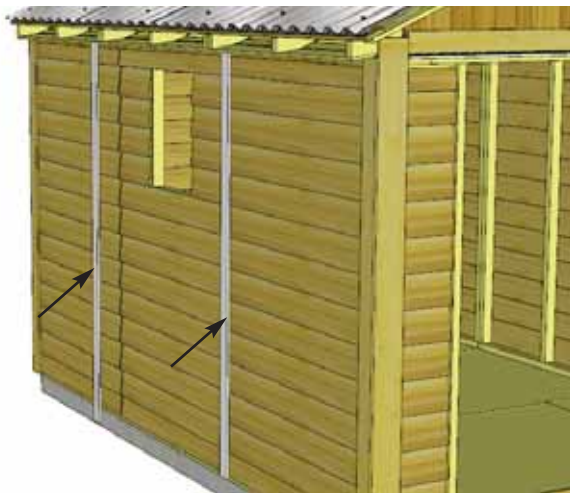

69. Attach **Side Wall Narrow Trim** where wall panels come together and leave a seam. Position trim equally on wall seam and tight underneath Soffit and Rafter. Use **8 - 1 1/2" Finishing Nails** per piece to secure.

<u>Parts</u>
Side Wall Narrow Trim (1/2" x 2 1/2" x 79") x 5
<u>Hardware</u>
N1 - 1 1/2" Finishing Nails x 40 total

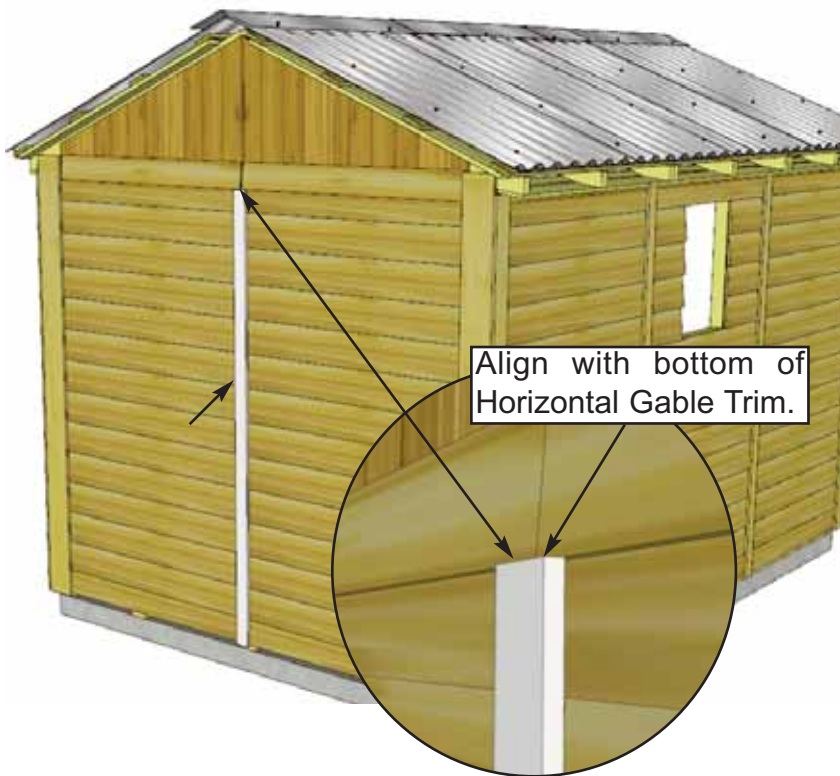

Align with bottom of Horizontal Gable Trim.

70. Attach **Rear Wall Narrow Trim** where wall seams come together on back of shed. Position equally on wall seam and flush with the bottom of the Horizontal Gable Trim. Secure with **8 - 1 1/2" Finishing Nails**.

Parts

Rear Wall Narrow Trim
(1/2" x 2 1/2" x 77 1/2") x 1

Hardware

N1 - 1 1/2" Finishing Nails x 8 total

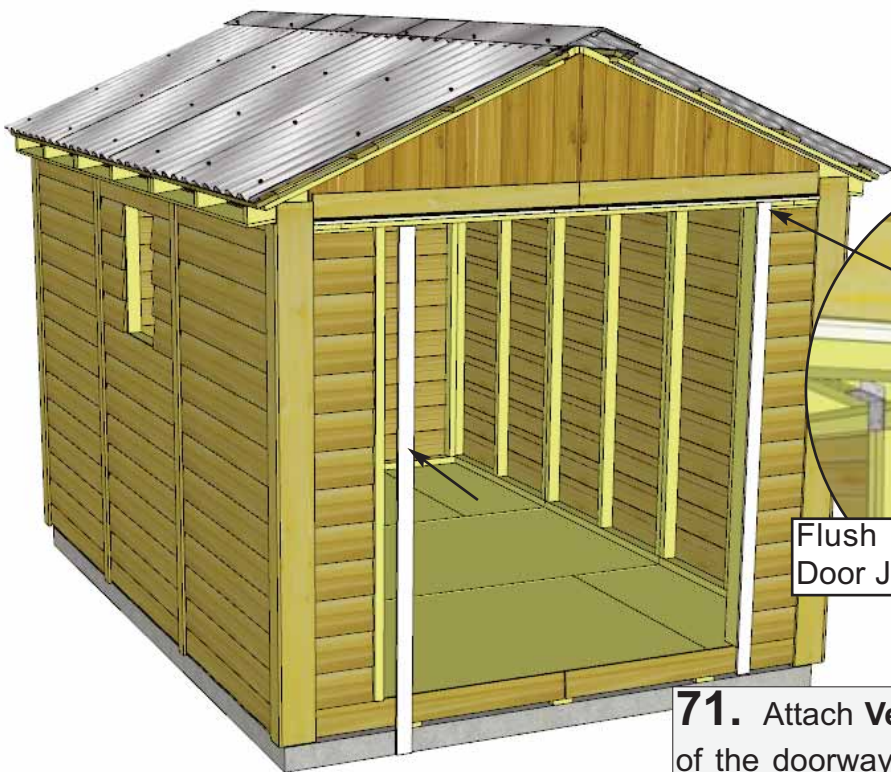

Flush with Door Jamb.

Fit Door Trim tight underneath Drip Cap.

71. Attach **Vertical Door Trim** on both sides of the doorway. Position flush with Door Jamb and tight under the lip of the Drip Edge. Secure with **8 - 1 1/2" Finishing Nails** per piece.

Parts

Vertical Door Trim
(1/2" x 2 1/2" x 79") x 2

Hardware

N1 - 1 1/2" Finishing Nails x 16 total



72. Attach **Horizontal Door Trim** and **Horizontal Narrow Wall Trim** onto the exposed part of the Door Header, and tight under the lip of the Drip Cap. Secure Horizontal Door Trim with **5 - 1 1/2" Finishing Nails** and the short Narrow Wall Trims with **2 - 1 1/2" Finishing Nails** per piece.

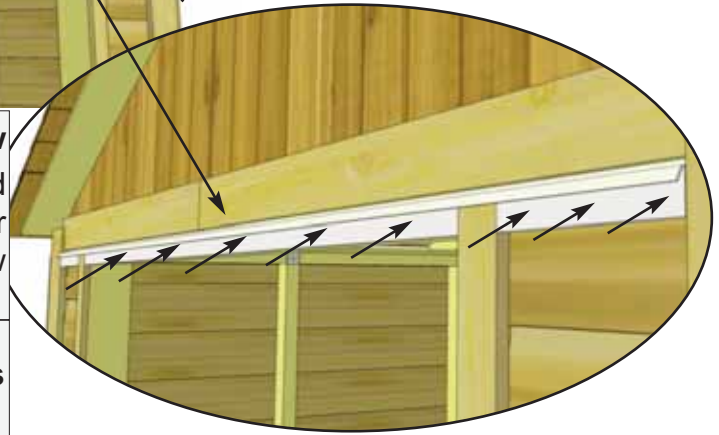

Parts	Hardware
Horizontal Door Trim (1/2" x 1 1/2" x 64") x 1	N1 - 1 1/2" Finishing Nails x 9 total
Horizontal Narrow Wall Trim (1/2" x 1 1/2" x 9") x 2	

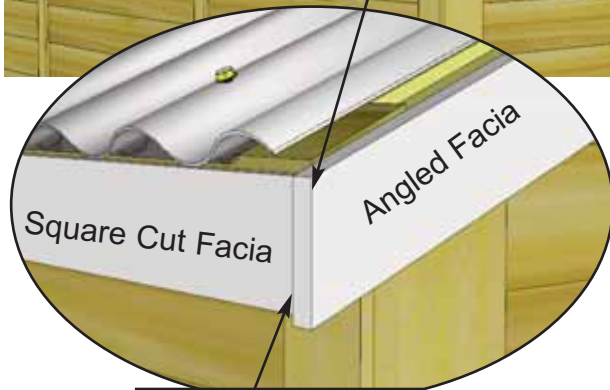

Angled Fascia caps Square Cut Fascia.

73. Position **Rear Fascia** (angle cut on ends) and **Side Fascia** (square cut ends) in corner. Line Fascia up so angle cut Fascia caps square cut Fascia. Attach angled Fascia to Nailing Strip with **8 - 1 1/2" Finishing Nails** per piece. Gap where fascia boards come together at peak will be covered in **Step 73**. Do a dry run using Side Fascia to help you correctly position before attaching.

Parts (Steps 73 - 74)

Front & Rear Fascia - Angle Cut Ends
(3/4" x 3 1/2" x 58") x 4

Side Fascia
(3/4" x 3 1/2" x 71 3/4") x 4

Hardware (Steps 73 - 74)

N1 - 1 1/2" Finishing Nails x 64 total



74. Attach remaining **Front & Rear Fascia** as per **Step 71** and attach **Side Fascia** to Rafter ends. There are 2 Fascia pieces per side. Secure with **8 - 1 1/2" Finishing Nails** per piece, ensure nails connect with the ends of the Rafters behind Fascia. Gaps between Fascia pieces will be covered by Detail Plates in **Step 75**.



75. Attach **Pentagon Fascia Plates** where Front & Rear Facias meet at the peak. Secure with **4 - 1 1/2" Finishing Nails** per piece. Attach **Fascia Detail Plates** to cover seams where Side Fascia pieces meet. Secure with **4 - 1 1/2" Finishing Nails** per piece. Attach **Horizontal Gable Detail Plates** to cover seams where Horizontal Gable Trims meet. Secure with **4 - 1 1/2" Finishing Nails** per piece.

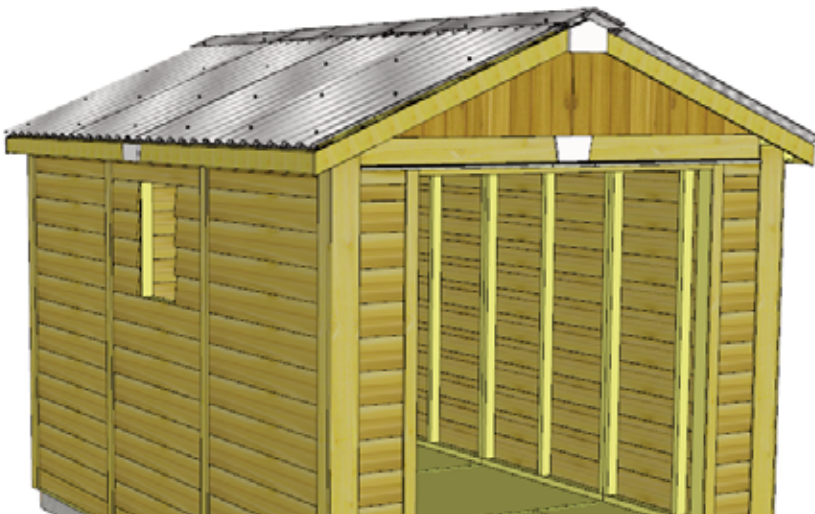

<u>Parts</u>
Pentagon Fascia Plates (1/2" x 5 1/2" x 8") x 2
Fascia Detail Plates (1/2" x 3 1/2" x 8") x 2
Horizontal Gable Plates (1/2" x 4 1/2" x 8") x 2
<u>Hardware</u>
N1 - 1 1/2" Finishing Nails x 24 total

Note: illustration of Hinge may not be accurate.

The # of screw holes in the hinge may vary from three to four depending on model.

Attach Black Tee Hinges
with 3/4" & 2" Black
hardware provided

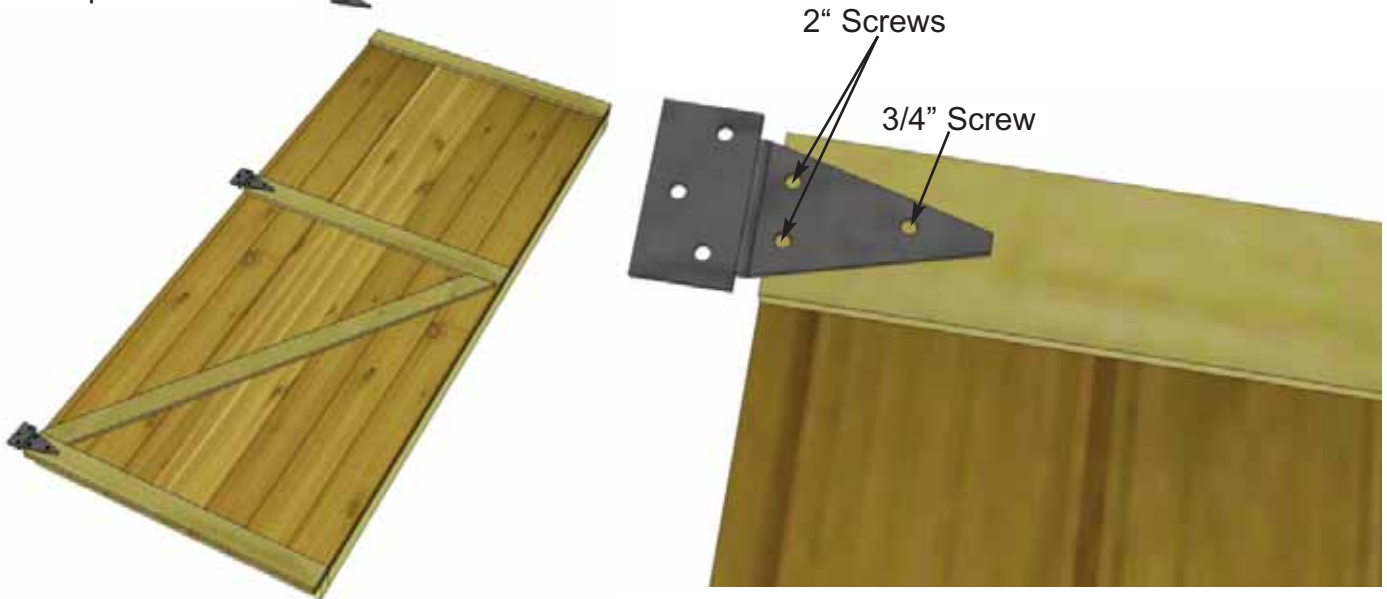

76. Attach Door Hinges to both **Left** and **Right Side Double Doors**. Position Hinges equally on door trim as shown above and attach with Black 3/4" and 2" screws.

Parts (Steps 76 - 78)
Left Side Door
 (31 1/2" x 72") x 1
Right Side Door
 (31 1/2" x 72") x 1

Hardware (Steps 76 - 78)
Y1 - Tee Hinges x 6 total
SB1 - 3/4" Black Screws x 6 total
SB2 - 2" Black Screws x 30 total

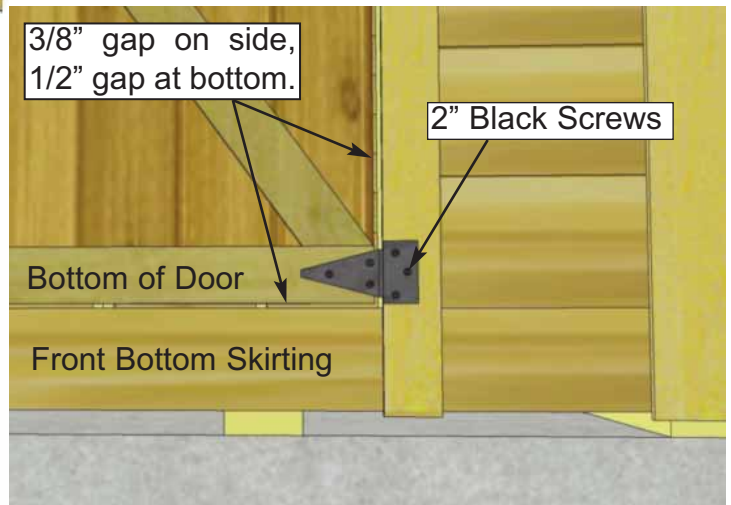

77. Next, position and secure the Double Doors. Starting with **Right Side Door**, position so there is a 1/2" gap on bottom and approximately 3/8" on the side. Use a spare Shingle to shim door in place at the bottom. Secure hinges to Door Trim with **3 - 2" Black Screws** per hinge. **Hint:** Do not attach all the 2" screws until both doors are positioned correctly into place. Use Screw Driver to tighten screws completely.



78. Position **Left Side Door** as per **Step 77** and secure with 2" Black Screws. When satisfied with door positioning, complete all 2" Black Screw attachments. **Note:** Do not over tighten hinge screws when using screw gun. Tighten 3/4 of the way and use a Screw Driver to finish so as not to strip screws.

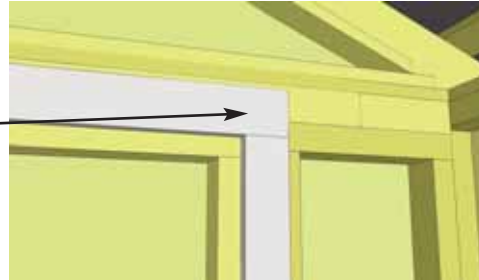

79. Attach **Horizontal** and **Vertical Door Stops** to Door Header and Jambs. Start with Horizontal Stop first and then complete both Vertical Stops. Position so door gap is covered. Use **4 - 2" Screws** per piece to secure.

Parts	Hardware
Horizontal Door Stop (1/2" x 2 1/2" x 68") x 1	S3 - 2" Screws x 12 total
Vertical Door Stops (1/2" x 2 1/2" x 72") x 2	

80. Close both doors and align so doors are straight. Attach **Door Threshold** with **4 - 2" Screws**, centering between doorway.

Parts
Door Threshold (3/4" x 2 1/2" x 62 1/2") x 1
Hardware
S3 - 2" Screws x 4 total

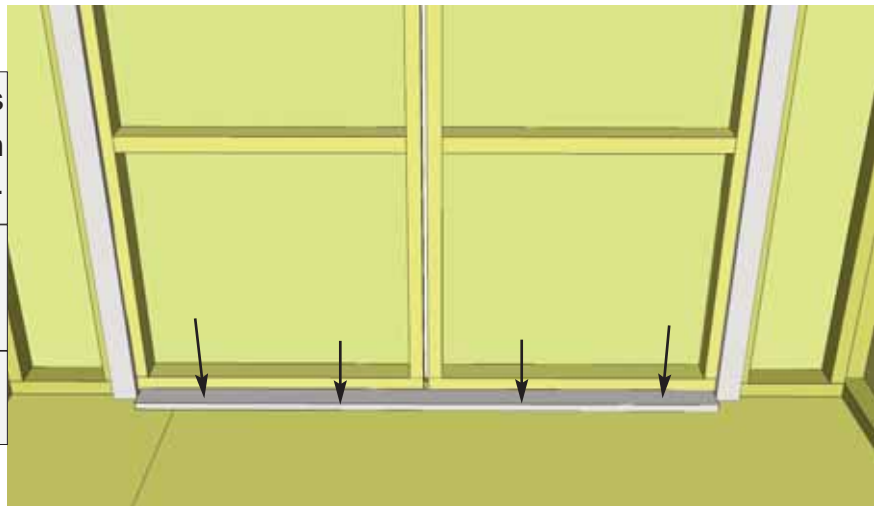

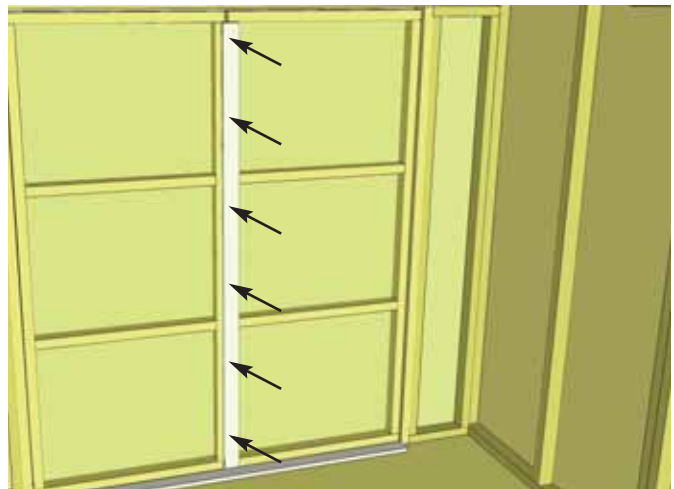
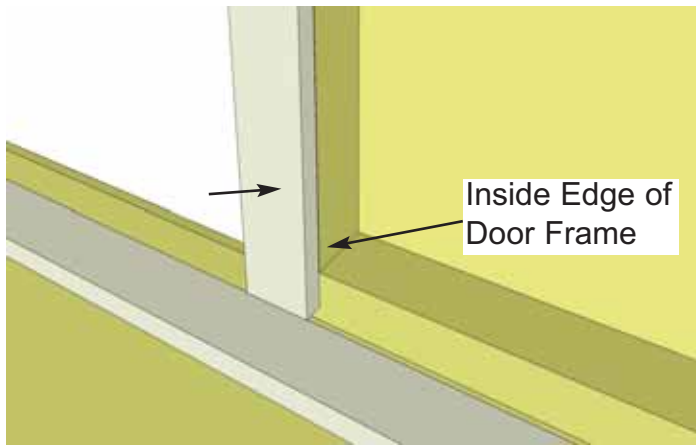

81. Position and attach **Vertical Door Flange** on inside edge of door frame (**left door from outside**) using **6 - 2" Screws**.

Parts
Interior Door Flange
 (1/2" x 2 1/2" x 71") x 1

Hardware
S3 - 2" Screws
 x 6 total

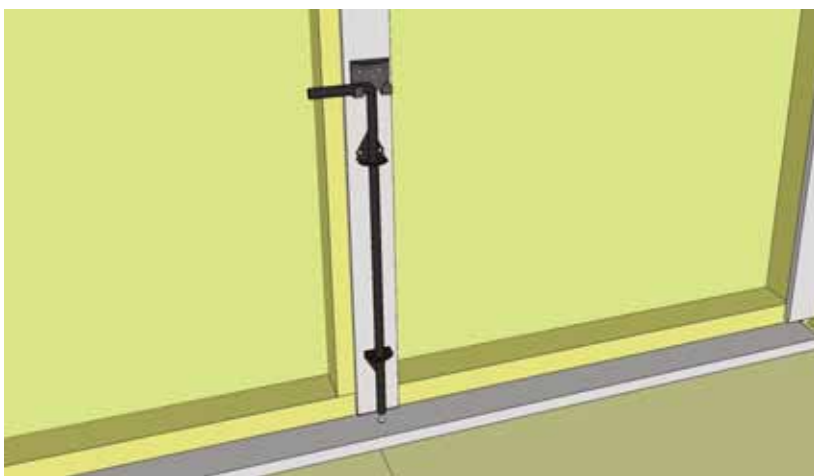

Drill 1/2" Diameter Hole to accommodate rod of Cane Bolt.

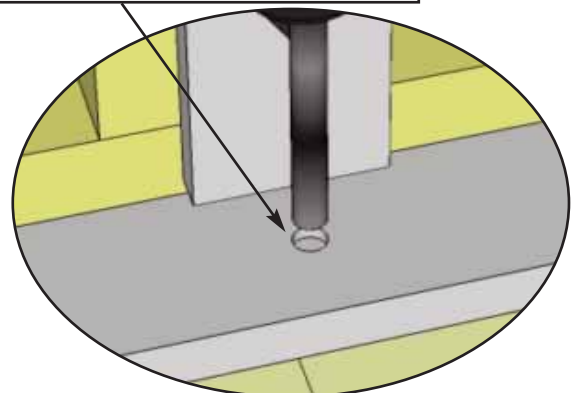

82. The Interior **Cane Bolt** will be attached to Vertical Door Flange. To position Cane Bolt correctly, attach to flange first, close doors and mark hole to house Cane Bolt Rod. Open doors and drill hole where previously marked with 1/2" bit. Attach Cane Bolt with 3/4" black screws.

Hardware
Y6 - Cane Bolt x 1 total
SB1 - 3/4" Black Screws
 x 6 total



83. Attach **Door Handles** and Exterior Black **Drop Latch** to door. Attach Drop Latch as illustrated above with **5 - 2" Black Screws** & **1 - 3/4" Black Screw**. Note how female part of Drop Latch is positioned higher than male. Do a dry run first to position Drop Latch correctly. Attach each Door Handle with **4 - 3/4" Black Screws**, ensure screws connect with inner door stud.
Important: Drill pilot holes with 1/8" drill bit prior to securing with screws to prevent wood splitting.

Hardware
Y3 - Door Handles x 2 total
Y4 - Drop Latch x 1 total
SB1 - 3/4" Black Screws
 x 9 total
SB2 - 2" Black Screws
 x 5 total

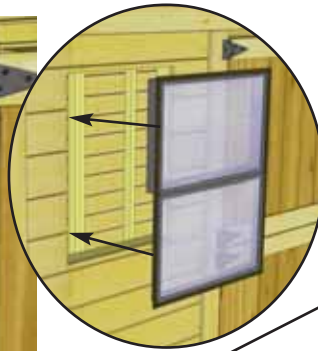
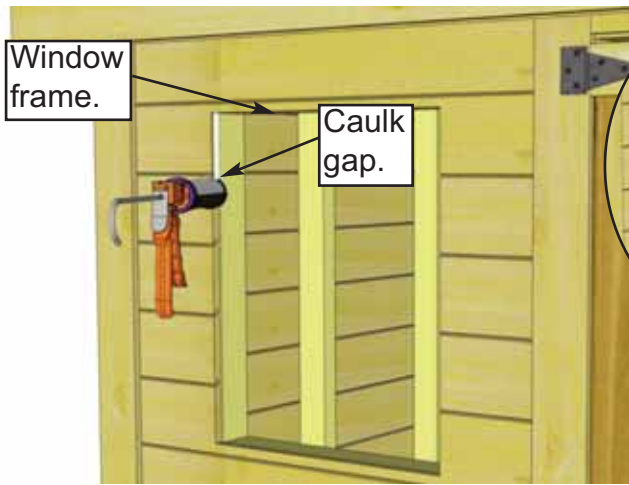

84. To reduce possible water from penetrating into the window cavity, caulk gap on both sides of window opening prior to installing **Window Insert**. Position insert in cavity and screw with **8 - 1 1/4" Screws**.

Parts (Step 84)
Window Insert x 1

Hardware (Step 84)
S2 - 1 1/4" Screws
x 8 total

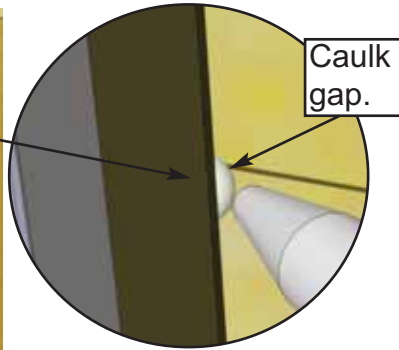

85. Once Insert is attached, caulk the "channel gap" between the Insert's outside flange and the siding. Also put a bead of caulking horizontally at top of window where the flange and siding meet. This additional caulking will also reduce the chances of moisture entering into your shed.

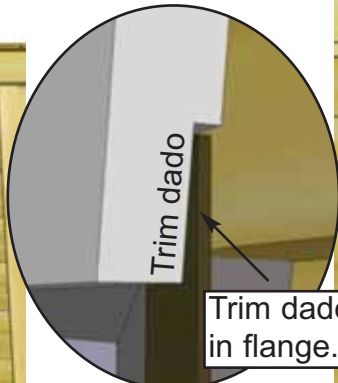

86. Position **Window Trim** around window doing a dry run first and attach with **4 - 1 1/2" Finishing Nails** per piece. Window trim has a small dado on reverse face. Outside flange of window will roughly sit in the dado to give a better fit.

Parts

Window Trim Package x 1

(Top - 24 1/16" Long - Angle Cut Ends) x 1
(Sides & Bottom - 23" Long) x 3

Hardware

N1 - 1 1/2" Finishing Nails
x 16 total



87. Assemble **Flower Box** with Assembly Instructions included on Page 45. Position completed Flower Box below bottom of window trim and secure with **2 - 2" Screws**. Screw from inside of box into the center Window Wall stud. Attach second screw 2" underneath first screw and once again into the wall stud.

<p><u>Parts</u> Flower Box Kit x 1 <u>Hardware</u> S3 - 2" Screws x 2 total</p>

Outdoor Living Today Flower Box Assembly Instructions

Parts Lists:

A - Base, Rear & Front Box Frames	(3pcs)	3/4" x 5 1/2" x 23"
B - End Cap Frames	(2pcs)	3/4" x 5 1/2" x 7" / 8"
C - Front Trim	(1 pc)	3/4" x 1 1/2" x 26"
D - Side Trims	(2 pc)	3/4" x 1 1/2" x 8 3/4"
E - Brackets	(2 pc)	1 1/2" x 5 1/2" x 5 1/2"
F - 1 1/4" Screws		
G - 1 1/4" Nails		

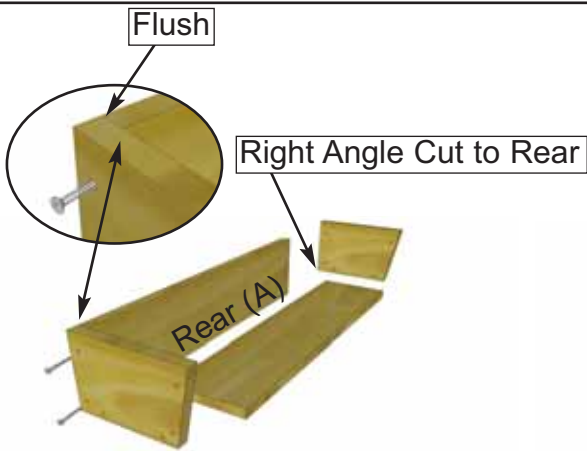
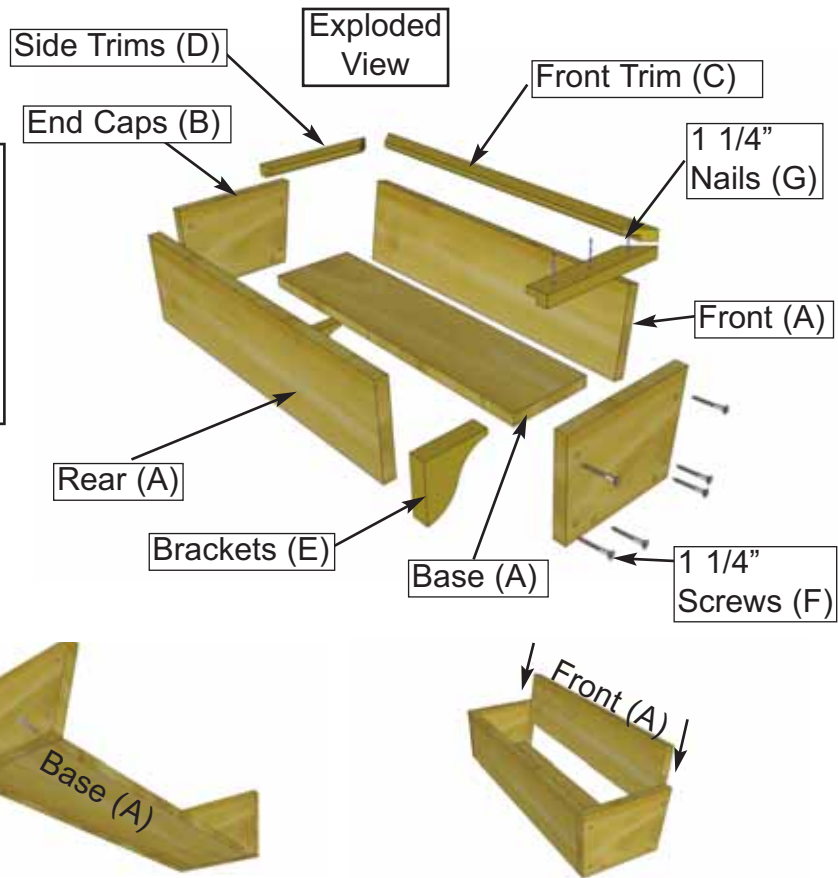

1. On a table position Rear Box and End Cap Frames together so flush at top. Fasten together with 2 - 1 1/4" screws. Place Base Frame tight against Rear and End Cap and flush at bottom. Secure with 2 - 1 1/4" screws. Complete attachment of remaining End Cap Frame. Slide Front Frame between End Caps.

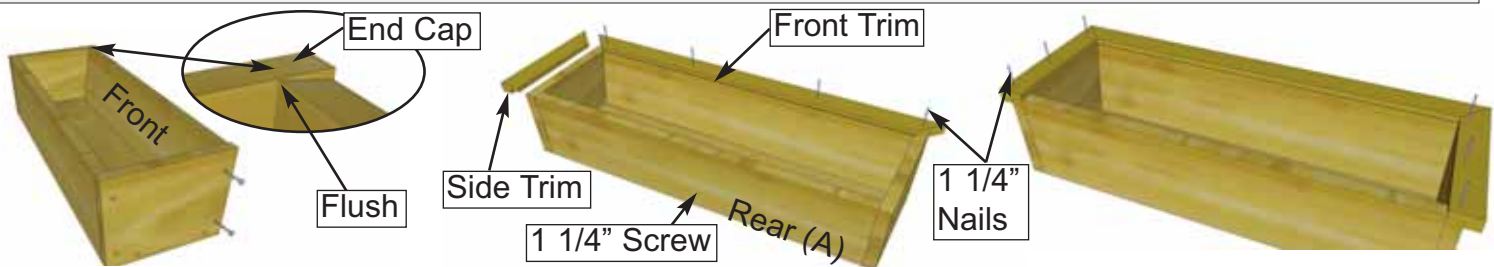

2. Position Front Frame Piece flush with End Cap. Attach both ends with 2 - 1 1/4" screws. Pilot hole Rear Box Frame near bottom center and secure to Base edge with 1 - 1 1/4" screw. Evenly position Front Trim (mitre cut on end and dado cut on inside bottom) tight against front frame and nail down with 4 - 1 1/4" nails. Position Side Trims as per Front and secure with 3 - 1 1/4" nails per side.

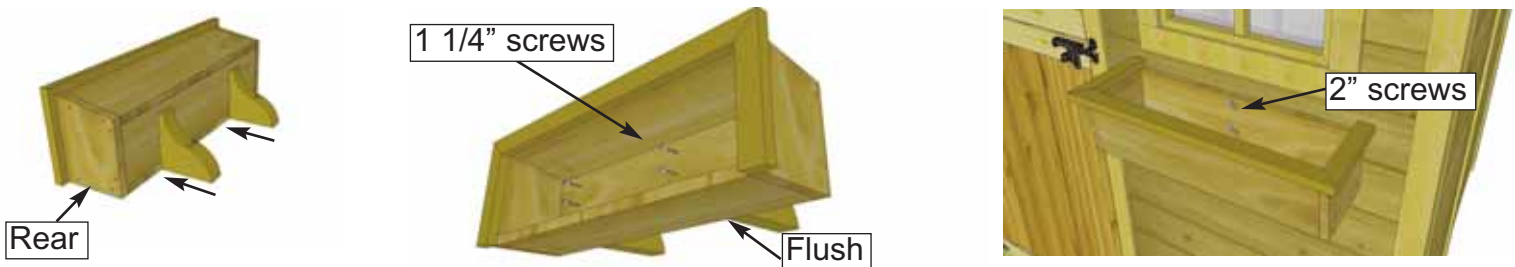

3. On a flat surface, flip Flower Box on it's rear face. Evenly space Brackets and secure through Base Frame and into the Brackets with 2 - 1 1/4" screws per Bracket. Position completed Flower Box beneath window trim and screw from inside of box into the center wall stud with 2 - 2" screws. (2" screws supplied with Base Kit.)



Congratulations on assembling your 8x12 SpaceMaker!

Note: Our Sheds are shipped as unfinished products. If exposed to the elements, the western red cedar lumber will weather to a silvery-gray color. If you prefer to keep the cedar lumber looking closer to the original color, we suggest that you treat the wood with a good oil base wood stain. You may also wish to paint your new shed rather than stain it. In both cases we recommend that you consult with a paint and stain dealer in your area for their recommendations.

We hope your experience assembling your 8x12 SpaceMaker Garden Shed has been both positive and rewarding.

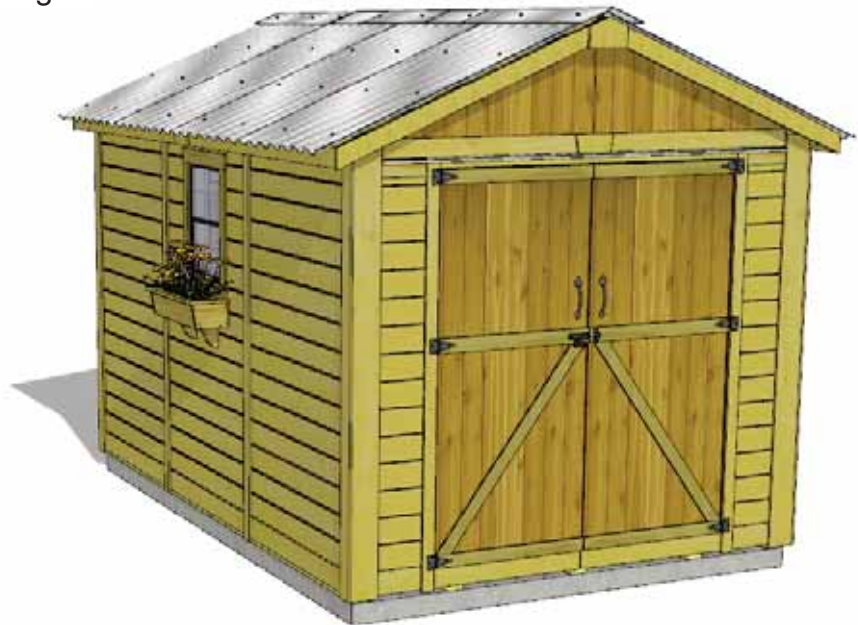

We value your feedback and would like to hear back from you on how well we are doing in the following areas:

- 1. Customer Service**
- 2. On Time Shipping**
- 3. Motor Freight Delivery**
- 4. Quality of Materials**
- 5. Assembly Manual**
- 6. Overall Satisfaction.**

Please call, write or email us at:

Outdoor Living Today

Canadian Address
9393 287th Street
Maple Ridge, British Columbia
Canada V2W 1L1

United States Address
P.O. Box 96
Sumas, Washington
USA 98295



The materials contained in this Assembly Manual may be downloaded or copied provided that ALL copies retain the copyright and any other proprietary notices contained on the materials. No material may be modified, edited or taken out of context such that its use creates a false or misleading statement or impression as to the positions, statements or actions.