



12x4 Lorem Ipsum Sliding Doors - Metal Roof - ES Siding Assembly Manual

Stock Code:
#####

Version #1.0
April 11, 2022

Thank you for purchasing a 12x4 XXXXXXXX Shed with Sliding Doors. Please take the time to identify all the parts prior to assembly.

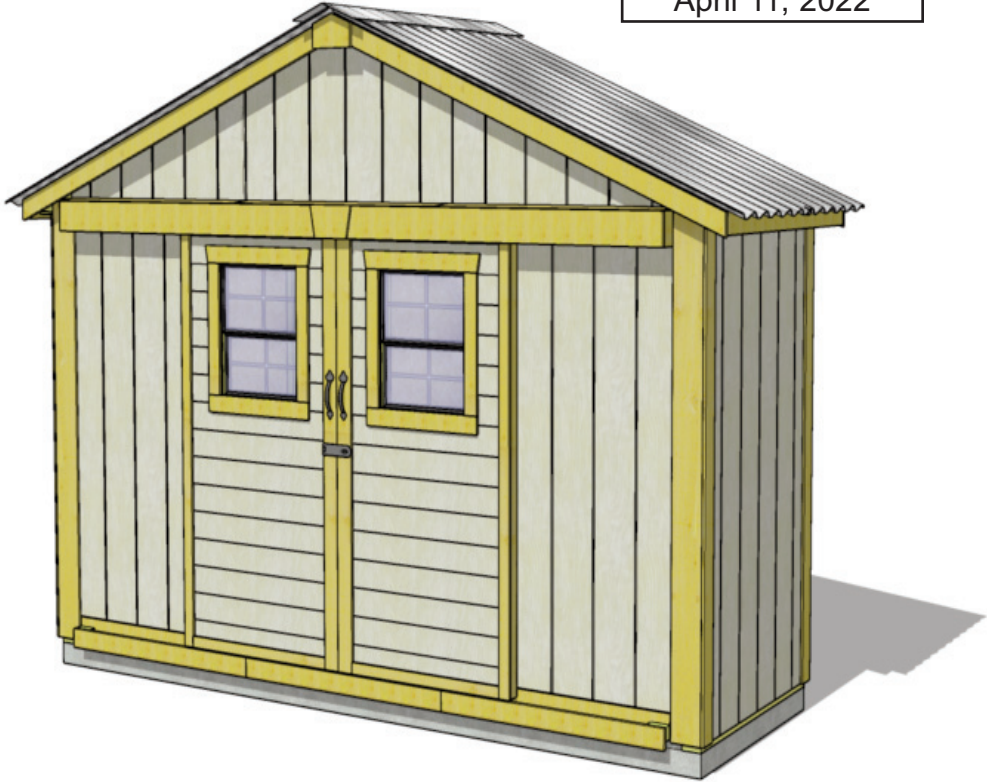

Safety Points and Other Considerations

Our products are built for use based on proper installation on level ground and normal residential use. Please follow the instruction manual when building your shed and retain the manual for future maintenance purposes.

Customers are responsible for ensuring a solid, level, well-draining site for construction.

Please check with your local municipal or county by-laws before ordering this product to confirm it complies with building codes.

- Snow load ratings vary by geographical location. If heavy or wet snowfall occurs, it is advisable to sweep snow off roof frequently.
- If the product is elevated, any structural and building code requirements are solely the customer's responsibility, and should be abided by.
- In areas with high or gusty wind conditions, it is advisable to install the structure securely to the ground.
- Have a regular maintenance plan to ensure screws, doors, windows and parts are tightly affixed.



Customer agrees to hold Outdoor Living Today and any Authorized Dealers free of any liability for improper installation, maintenance and repair.

In the event of a missing or broken piece, call the Outdoor Living Today Customer Support Line @ 1-888-658-1658 within 30 days of the delivery of your purchase. It is our commitment to you to courier replacement parts, free of charge, within 10 business days of this notification. Replacement parts will not be provided free of charge after the 30 day grace period.

All structures purchased from Outdoor Living Today are covered for a period of one year for defects in manufacturing and workmanship. Costs incurred for customer installations are not included.

Failure to use supplied parts included in this kit could result in poor product performance and may void your warranty. Please contact Outdoor Living Today's Customer Toll Free Line if you plan to deviate from our written instructions.

What to do before my Shed arrives?



- Become familiar with this assembly manual and determine if you can complete the project yourself or will require a professional contractor.



- One helper is recommended to assist in constructing your shed. It generally takes two people over two days to assemble a shed. If you're hiring a contractor, their rate should be in line with that duration of work.



- Clear the construction area and ensure a clear pathway for delivery when the freight company arrives. Remove all debris: roots, grass, rocks, etc.



- Excavate the site. Contact your local utilities company to ensure there are no gas or electric lines buried in the area before digging.

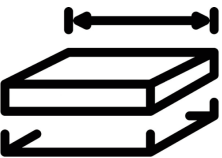

- Decide on the type of foundation you will be using:
 - Concrete slab, or
 - 4-6 inches of crushed gravel with paver stones or 4x4 stringers.

You can find the footprint for your shed on Page 3 of your Assembly Manual.



- If doing the assembly yourself, have all the necessary tools ready to go and in working condition. A list of required tools can be found after the parts list.

Foundation Types for 12x4 Garden Shed

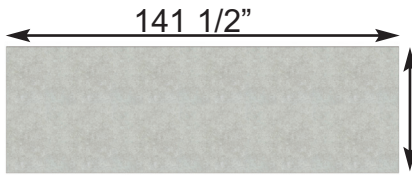

Concrete Foundation

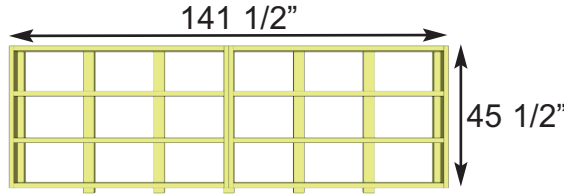

Floor Frame

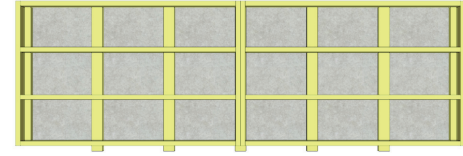

Completed Foundation

Concrete Slab Foundation:

- Slab must be at least the same size as assembled floor frame (45 1/2" x 141 1/2") or larger.
- 6" Deep foundation.
- 0.9 Cubic Yards of concrete required.
- A concrete slab will have the longest durability out of your foundation options.

Once level, a concrete slab is the easiest surface to build on.

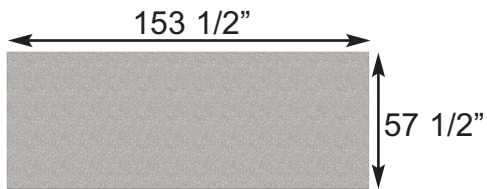

Gravel Foundation

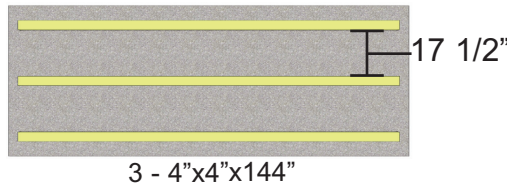

Gravel Foundation with treated stringers

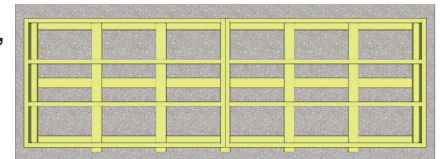

Completed Foundation

Gravel with 4x4 Pressure Treated Stringers:

- Excavate at least 6" deep, and 6" wider than floor frame on each side.
- 1.2 Cubic Yards of gravel required, approximately 11 wheelbarrows.
- 3 - 4x4 Pressure Treated Stringers 12' long required.
- Evenly spaced, with one at each end of floor frame.

Saves money on materials, easy to level and work with.



Gravel Foundation

21 Patio Stones

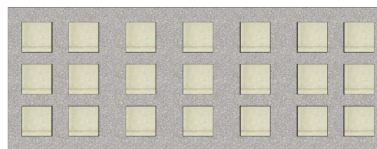

Gravel Foundation with Patio Pavers

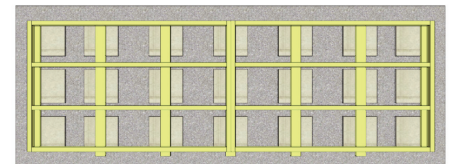

Completed Foundation

Gravel with Patio Paver Stones:

- Excavate at least 6" deep, and 6" wider than floor frame on each side.
- 1.2 Cubic Yards of gravel required, approximately 11 wheelbarrows.
- 21 patio pavers (8" x 8" or larger).
- Center patio paver stones underneath floor runners and underneath seams in floor joists.

Patio paver stones are widely available from most landscape stores.

Thank you for purchasing our 12x4 XXXXXXXXXX Sliding Door Shed.
Please take the time to identify all the parts prior to assembly.

1. Floor Section	Parts List - Pages 4 and 5	Steps ↓
Floors -----		1-6
2 - 45 1/2" x 70 3/4" - Floor Frames		
4 - 1 1/2" x 3 1/2" x 67 3/4" - Floor Joists		
2 - 1 1/2" x 3 1/2" x 45 1/2" - Floor Runners Short		
5 - 1 1/2" x 3 1/2" x 47 1/2" - Floor Runners Long		
2 - 5/8" x 45 3/8" x 70 5/8" - Plywood Floor		
2. Wall Section		Steps ↓
Main Wall Panels -----		
5 - 45 1/2" x 75" - Side/Rear Wall Panels		7-14
5 - 1 5/8" x 2 1/2" x 45 1/2" - Bottom Wall Plates - Side/Rear Walls		
2 - 1 5/8" x 2 1/2" x 35" - Bottom Wall Plates - Front Walls		
2 - 35" x 73" - Front Wall Panels		
Door Headers -----		15-17
2 - 2" x 2 7/8" x 26 1/4" - Door Headers - Short		
1 - 2" x 2 7/8" x 84" - Door Header - Long (88" Aluminum Strip Attached)		
1 - 1 1/2" x 2 7/8" x 66 1/2" - Interior Door Header		
Top Wall Plates & Gables -----		19-24
4 - 3/4" x 2 1/2" x 70 3/4" - Front/Rear Top Wall Plates		
2 - 3/4" x 2 1/2" x 40 1/2" - Side Top Wall Plates		
4 - 46 1/4" x 22 1/4" - L/R Triangular Gables		
2 - 45 1/2" x 31 7/8" - Pentagon Gable		
3. Rafter and Roof Section		Steps ↓
Rafters -----		
6 - 1 1/2" x 3 1/2" x 80 7/8" - Rafters		25-31
2 - 1/2" x 4 1/2" x 45 1/2" - Soffits		
2 - 3/4" x 4 1/2" x 45 1/2" - Ridge Boards		
1 - 3/4" x 3 1/2" x 75" - Gusset		
Roofs -----		32-45
10 - 3/4" x 3 1/2" x 51 3/4" - Roof Battens		
16 - 3/4" x 1 1/2" x 15 3/4" - Batten Spacers		
4 - 39" w x 86" d - Metal Roof Panels		
1 - 60" long - Metal Roof Ridge Cap		
8 - Foam Enclosures for Metal Roof		
4. Trim & Miscellaneous Section		Steps ↓
Bottom Skirting -----		
3 - 1/2" x 4" x 43 1/2" - Front Bottom Skirting		46
Filler Trim -----		
4 - 3/8" x 2 1/2" x 75" - Front Corner Filler Trims		47
Door System -----		48-52
2 - Aluminum Door Tracks		
2 - 36" x 73" - Sliding Doors		
2 - 1 1/2" x 1 5/8" x 60" - Lower Door Track		
3 - 1 1/2" x 2 1/4" x 3 1/2" - Sliding Door Track Stop		
3 - 3/4" x 3 1/2" x 43 1/2" - Lower Door Track Cover		
1 - 3/4" x 3 1/2" x 71 1/2" - Interior Door Flange		
Track Overlay -----		53-55
2 - 1 1/2" x 3 1/2" x 66" - Track Overlay Top		
2 - 3/4" x 5 1/2" x 66 1/2" - Track Overlay Front		
2 - 1/2" x 3 1/2" x 5 1/2" - Track Overlay Ends		
3 - 1/2" x 4 1/4" x 44 1/4" - Track Overlay Sill		
Outer Wall Trim -----		56-58
4 - 1/2" x 4 1/2" x 82" - Wide Corner Trims		
4 - 1/2" x 3 1/2" x 79" - Corner Trims		
3 - 1/2" x 4 1/2" x 44 1/4" - Horizontal Gable Trims		
2 - 1/2" x 2 1/2" x 77 1/2" - Rear Wall Trims		

Continued on next page

Note: All Trim, Facia, and Bottom Skirting pieces will be positioned rough face out when installed.

4. Trim & Miscellaneous Section Cont.

Facia

- 8 - 3/4" x 1 1/2" x 40" - Facia Nailing Strips
- 4 - 3/4" x 3 1/2" x 81 1/4" - Front/Rear Facia (Angle Cut Ends)
- 2 - 3/4" x 3 1/2" x 51 3/4" - Side Facia - Left/Right
- 2 - Pentagon Detail Plates
- 3 - Facia Detail Plates (2@ 4 1/2", 1@ 5 1/2")

Windows

- 2 - Window Inserts 18 1/4"w x 23"h
- 2 - Window Trim Kits
 - 1 - Top pc - 24 1/16" Length - Angle Cut Ends
 - 3 - Side/Bottom pcs - 23" Length

Miscellaneous

- 1 - Shim, Shingle
 - Use to shim floor or door.

Steps ↓

59-63

64-64

12X4 Lorem Ipsum with Metal Roof HARDWARE PACKAGE

BR1 - Square Drive Bit  x 2

1/4 Nut Driver  x 1

S5 - 4" Screws  x 6

S4 - 3" Screws  x 28

S1 - 2 1/2" Screws  x 129

S2 - 1 1/4" Screws  x 173

SB1 - 3/4" Screws  x 20
Black Headed

ST1 - 1 1/2" Torx Screws  x 12

N1 - 1 1/2" Finishing Nails  x 259

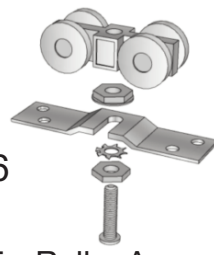

Y35 - Roller Assembly x4

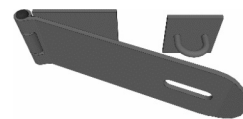

Y11 - Black Hasp x 1



Y38 - Metal Roof Hanger x 2

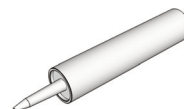

Silicon Caulking (1)



Y3 - Black Handle x 2

1/4" x 2" long  x 40
Metal Roof Screw

Tools Required (Not Provided)



Hammer



Utility Knife



Pliers



Tape Measure



Silicone Caulking

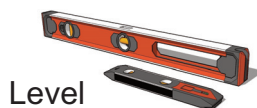

Level

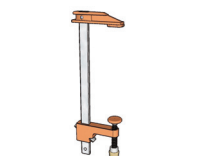

Wood Clamp



Ladder



1/8" Drill Bit

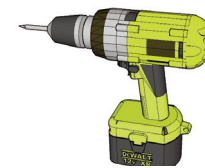

Screw Gun/Drill

Safety Equipment Required

(Not Provided)



Safety Glasses



Work Gloves

Before/During Assembly:

- 1.) Paint each face and edge of your plywood floor with a latex exterior paint.
- 2.) Caulk wall seams if gaps appear.
- 3.) Caulk around window framing.
- 4.) Caulk perimeter between floor plywood and bottom wall plate.
- 5.) Caulk channels in lap siding at the top of your door above the trim, just a drop in each channel.
- 6.) Caulk edge of door threshold (if applicable).
- 7.) Optional: Install a Sill Gasket between floor runners and foundation.
- 8.) Optional: Install an 8" strip of roofing paper below Cedar Ridge Caps for Cedar Roof Sheds.

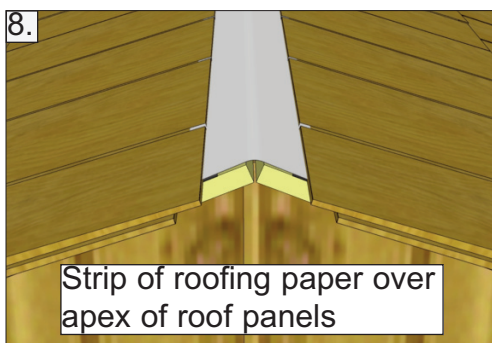
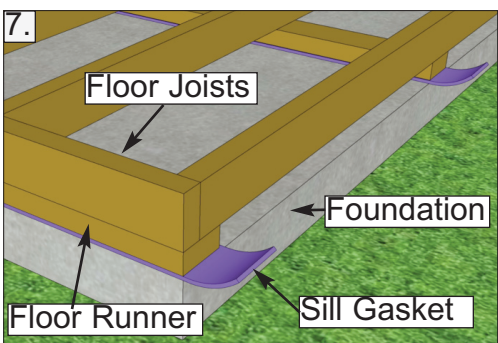
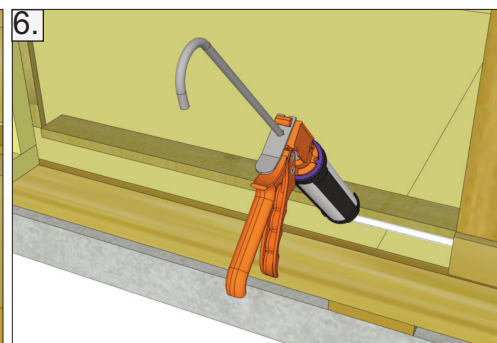
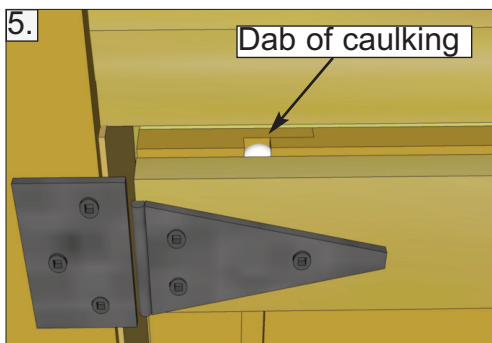
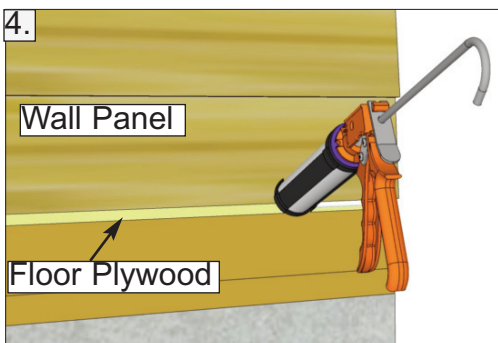
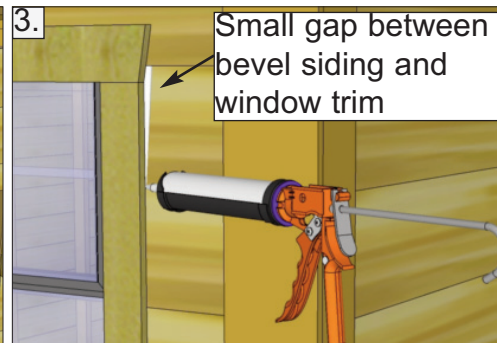
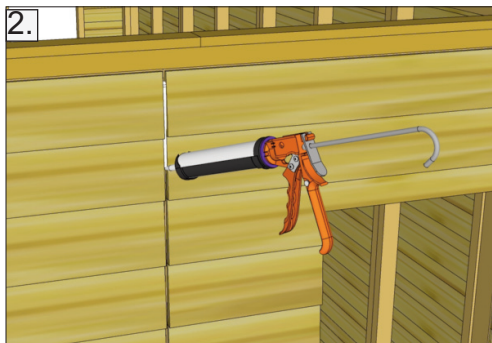
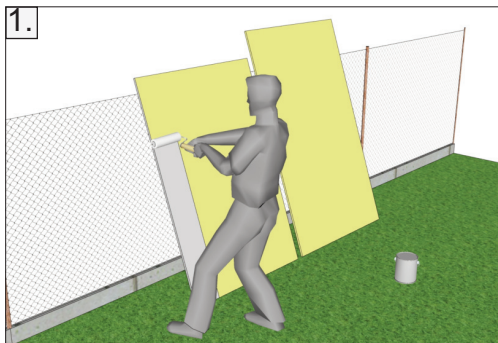

Routine Maintenance:

- Routinely check all fasteners are tight (ex. Door Hinges, Nails)
- Brush off dirt from walls.
- Brush off snow from roof regularly.
- Routinely remove needles and leaves from roof.

Painting/Staining

- Your cedar shed, if left untreated, will weather to a silvery grey colour.
- Painting or staining your structure is highly recommended and will prolong the life of your shed.
- You do not need to wait to paint or stain your shed, the wood in your kit has been dried and can be stained or painted immediately.
- Consult your local paint store for the best paint or stain for cedar.
- Optional: stain the inside of your shed. (Note: this will remove the fresh cedar smell.)

1. Floor Section

Exploded view of all parts necessary to complete Floor Section. Identify all parts prior to starting.
 Note: Floor Footprint is 141 1/2" wide x 45 1/2" deep.

Floor Frames - 2pcs.
 (Part 1A)

Plywood Floor - 2pcs.
 (Part 1D)

Center Floor
 Joists - 4pcs.
 (Part 1B)

Floor Runners - 7pcs.
 (Part 1C)

Concrete Pad
 (optional foundation method)

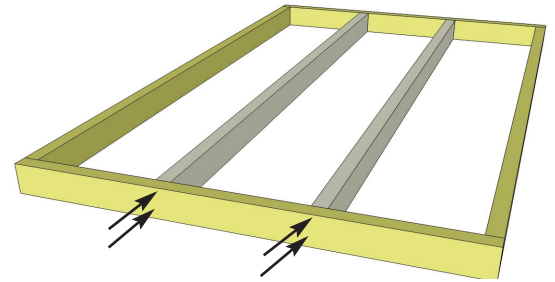
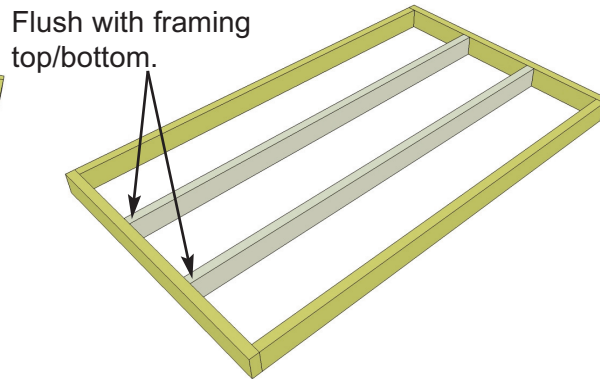
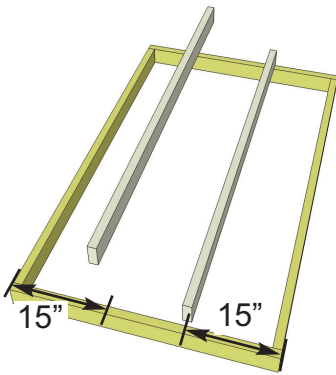

1. Lay out **1A - Floor Frame** and two **1B - Floor Joists** as illustrated above. Position the center of each Joist 15" from the outer edge of Floor Frame. When correctly positioned, attach each Joist with **4 - 2 1/2" Screws** (2 per end). **You can find the Square Drive Screw Bit in the Hardware Kit Bag.** Complete remaining Floor Frame the same.

<p><u>Parts</u> Floor Joist Frames (45 1/2" x 70 3/4") x 2 Floor Joists (1 1/2" x 3 1/2" x 67 3/4") x 4</p>
<p><u>Hardware</u> S1 - 2 1/2" Screws x 16 total</p>

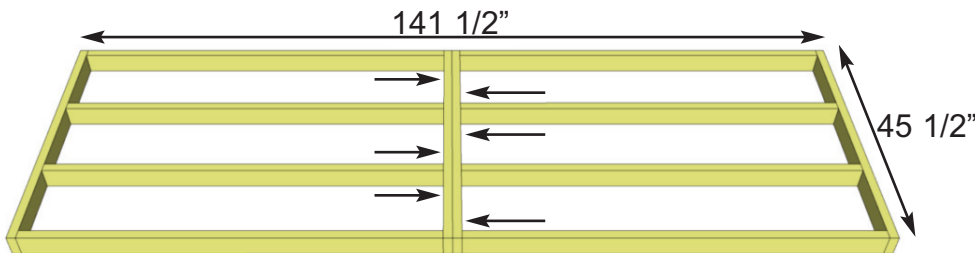

You can find BR1 - Square Drive Bit for the screws in with the Hardware Kit Bag.

2. Lay out both complete floor joist frames as illustrated. The footprint for the floor when attached together will be 141 1/2" wide x 45 1/2" deep. Attach frames together with **6 - 2 1/2" Screws**.

<p><u>Hardware</u> S1 - 2 1/2" Screws x 6 total</p>
--

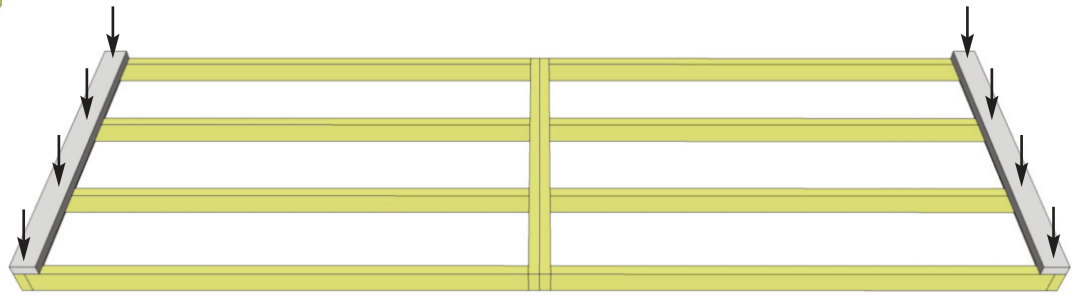
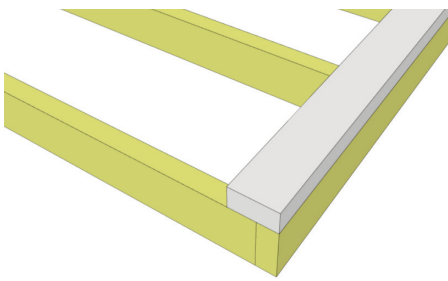

3. Position 1C - Floor Runners - Short on each side of the completed floor frame. Runners should be flush with corners but not overhanging. Attach with **4 - 2 1/2" Screws** per Runner.

Parts
Floor Runners - Short
 (1 1/2" x 3 1/2" x 45 1/2") x 2

Hardware
S1 - 2 1/2" Screws
 x 8 total

Floor Runners flush with Floor Frame on back.

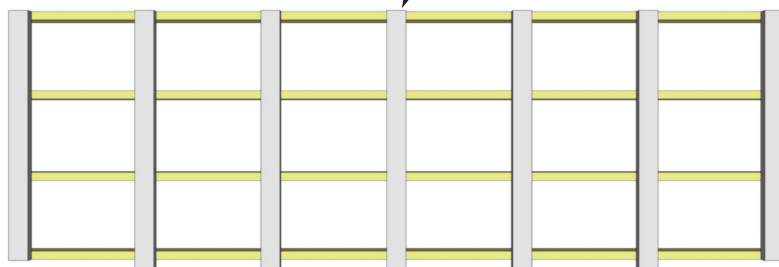

Long Floor Runners overhanging Floor Frame on front.

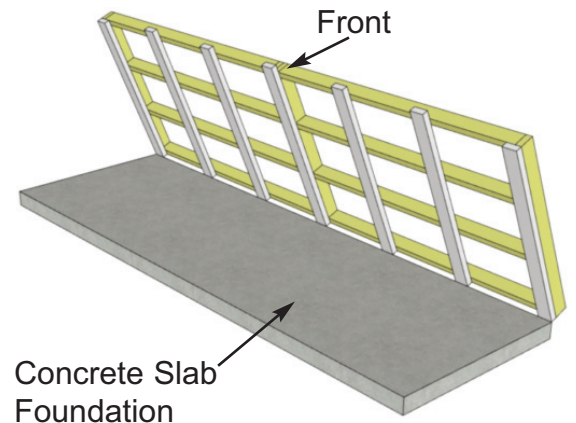

4. Align 1CC - Floor Runners - Long evenly spaced as shown above and flush with the back of the Floor Frame. On the front, Runners will extend 2" past the Floor Frame to provide support for the Sliding Door Track later in the Assembly. Attach with **4 - 2 1/2" Screws** per Runner. With Floor Runners attached, carefully flip the floor over and place on your foundation. **Caution** - Be careful when laying floor down not to bend or twist floor. **Note:** Having a level foundation is critical. Choosing a foundation will vary between regions. Typical foundations can be concrete pads or patio stones positioned underneath the floor runners.

Parts
Floor Runners - Long
 (1 1/2" x 3 1/2" x 47 1/2") x 5

Hardware
S1 - 2 1/2" Screws
 x 20 total

Note: Plywood is cut slightly smaller than floor framing. Keep plywood seams tight.

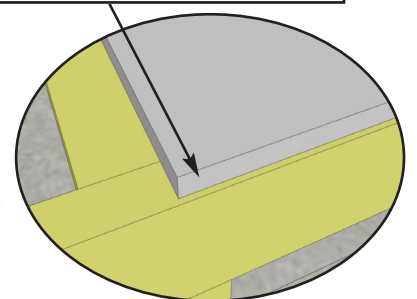
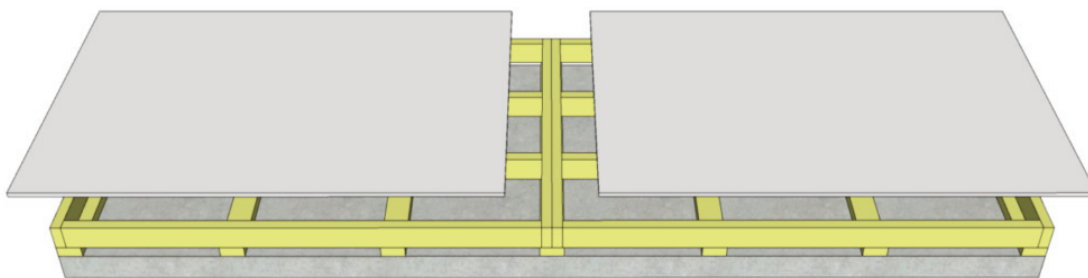

5. Position 1D - Plywood Floor on top of completed floor frames. Plywood will sit slightly inset from outside of floor frame.

Parts
Plywood Floor
 (5/8" x 45 3/8" x 70 5/8") x 2

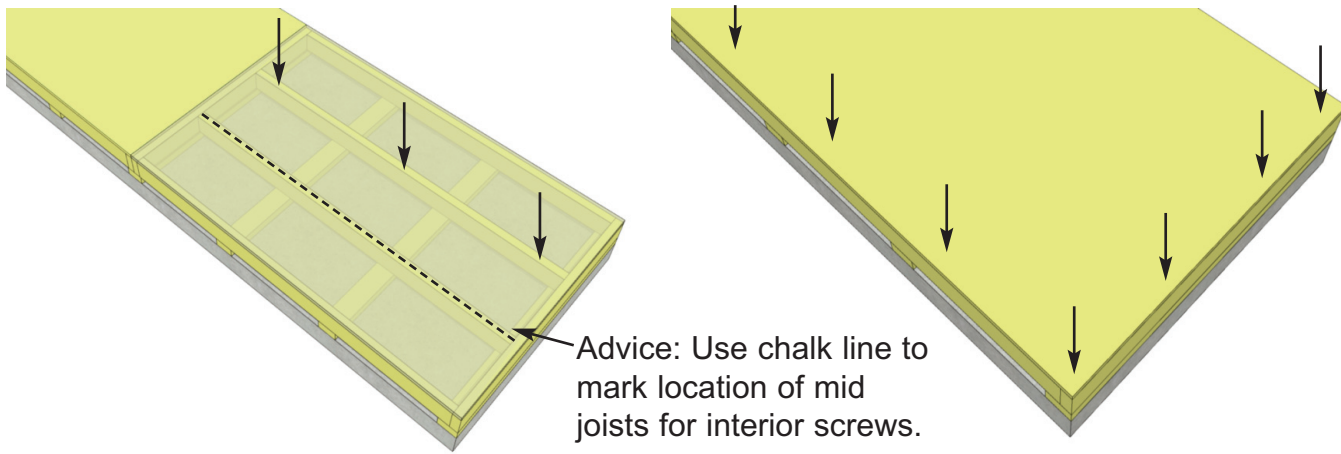

Advice: Use chalk line to mark location of mid joists for interior screws.

6. With Plywood positioned correctly on floor framing, attach with **1 1/4" Screws**. Use screws every 16" around perimeter of each floor section and 3 screws through each mid joists.

Hardware
S2 - 1 1/4" Screws
 x 40 total (approx.)

2. Wall Section

Exploded view of all parts necessary to complete the Wall Section. Identify all parts prior to starting.

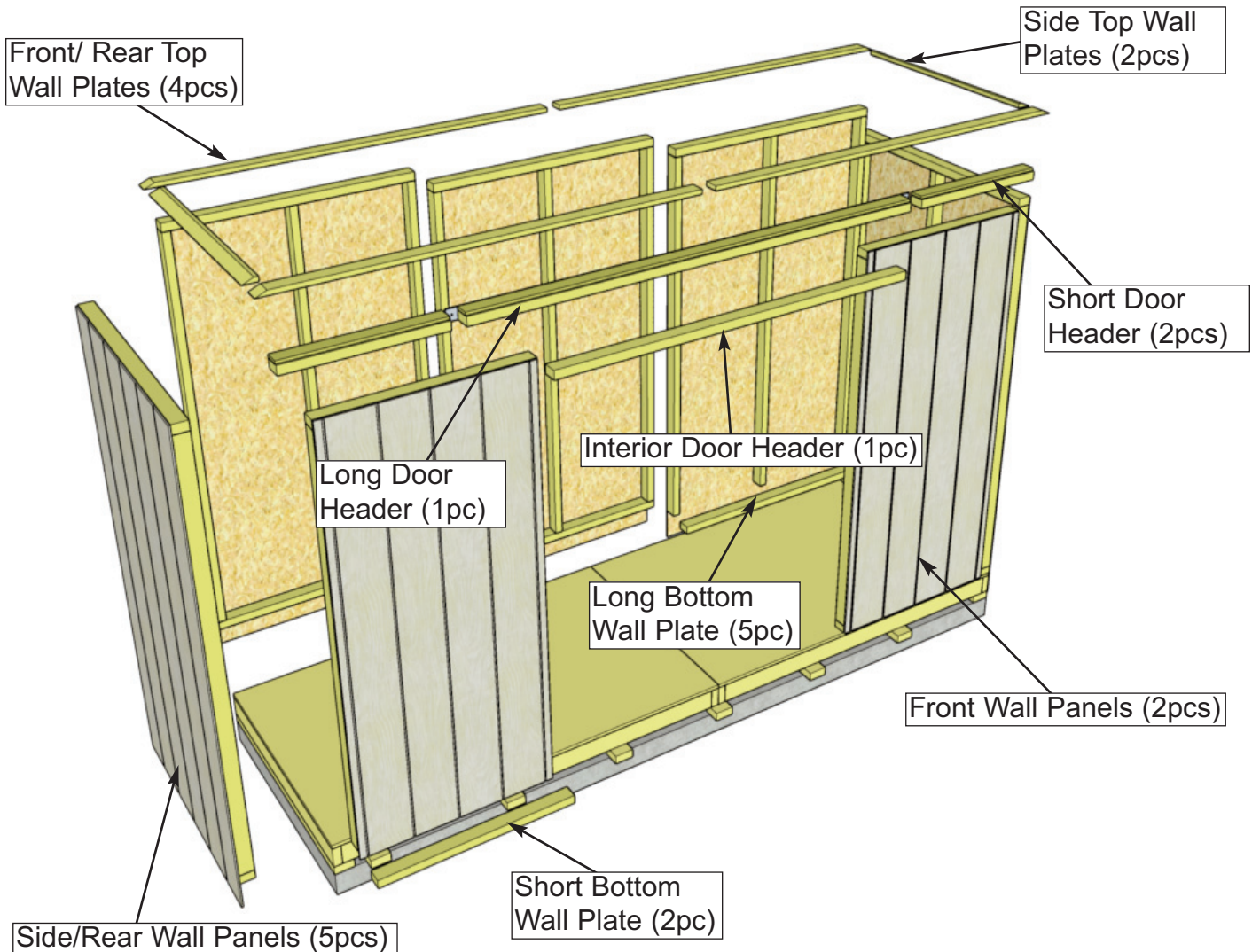

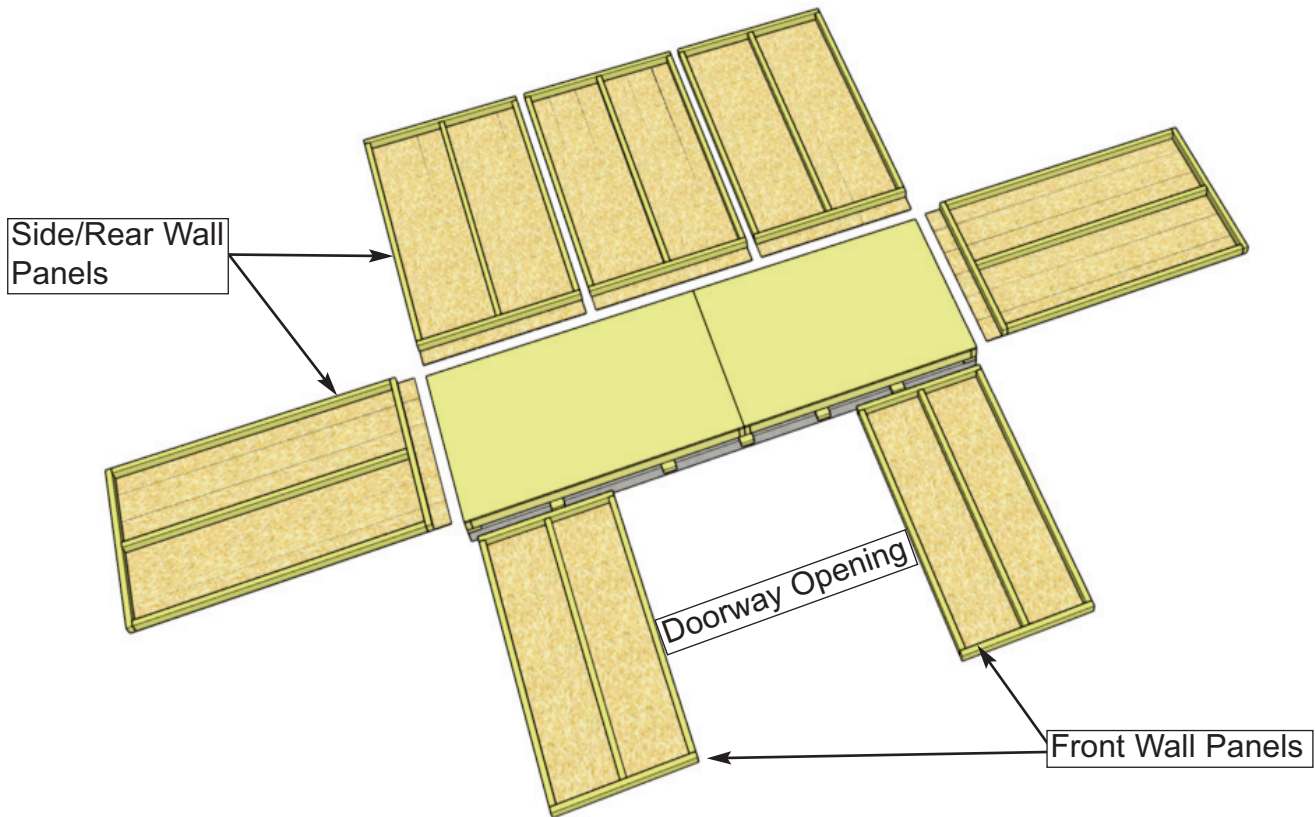

7. Layout all wall panels and become familiar with their location. On standard kits there are 2 Front Wall Panels and 5 Side/Rear Wall Panels.
Note: Siding on Wall Panels overhangs framing by 4 1/2" to cover floor frames on sides and rear.

<u>Parts</u>
Side/Rear Wall Panels (45 1/2" x 75") x 5
Front Wall Panels (35" x 75") x 2



8. Carefully lay **Side/Rear Wall Panels** face down. Position and attach **Bottom Wall Plates** to bottom of wall studs of each wall panel with **3 - 2 1/2" Screws**. Position so plates are flush with framing. Complete 4 remaining solid walls.

<u>Parts</u>
Side/Rear Wall Panels (45 1/2" wide x 75" high) x 5
Bottom Wall Plates (1 5/8" x 2 1/2" x 45 1/2") x 5

<u>Hardware</u>
S1 - 2 1/2" Screws x 15 total

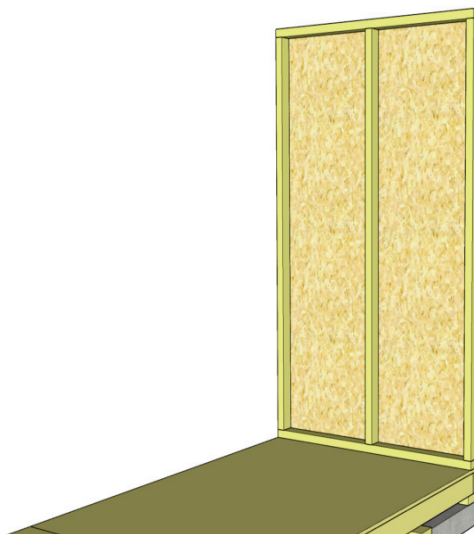

9. Starting on one side, position a Solid Wall Panel on top of plywood floor. The Wall Panel bottom framing will sit flush with the outside of the floor frame. Wall siding will overhang the floor.

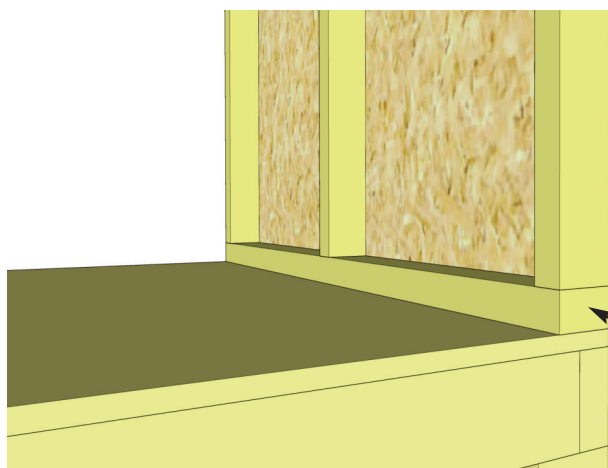

Do Not Attach Walls To Floor until Step 18.

Floor plywood may be slightly recessed

Siding overhangs floor frame by 4 1/2"

Outside 2x3 framing of wall panel should be positioned flush with the outside of floor framing when properly aligned.

10. The rear wall panels will sit even with the floor frame and the sidewall panels will be sandwiched between the front and rear wall panels. The floor plywood may be slightly recessed.

Note: Siding will overhang the floor frame by approximately 3/4".

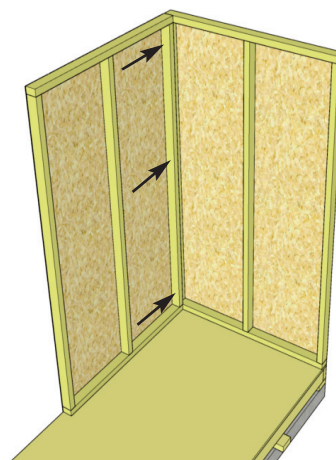
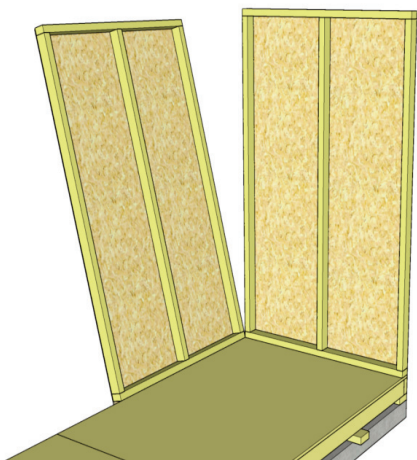

11. Position rear solid wall into place on plywood floor. Butt both vertical wall studs of side and rear walls together and attach with **3 - 2 1/2" Screws**. Screw at the bottom, middle and top of stud to secure properly.

Note: Drill pilot holes in studs to prevent splitting.

Hardware (Steps 10 - 12)

S1 - 2 1/2" Screws
x 12 total

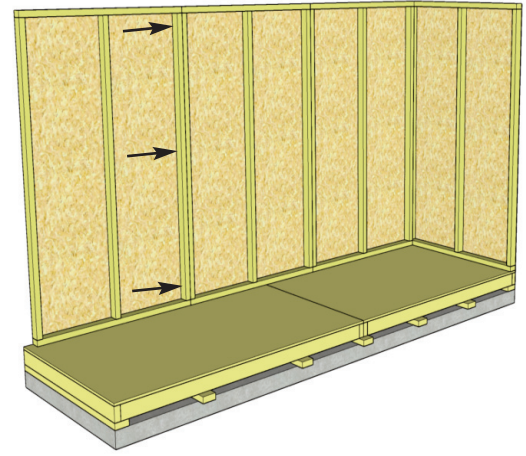
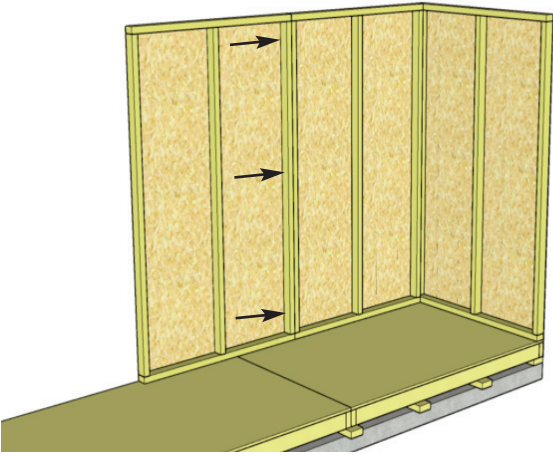

12. With the corner wall attachment complete, position a second rear wall panel in place so bottom 2x3 wall framing is sitting flush with outside floor joists. When positioned correctly, attach both side wall panel studs together as per **Step 11**.

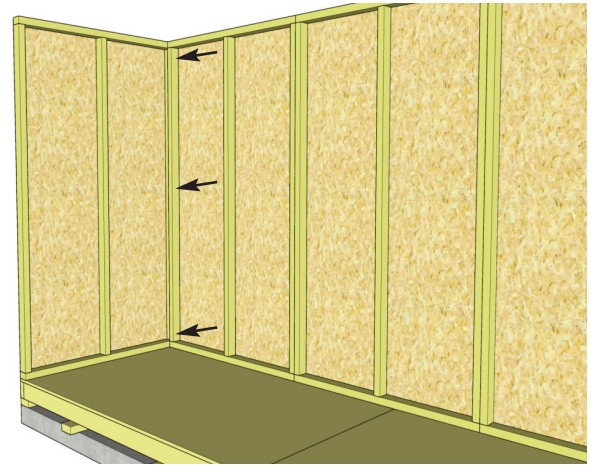
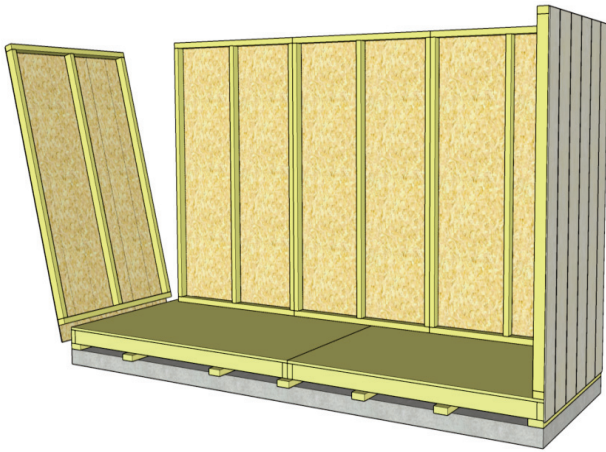

13. Complete remaining side wall attachment as per **Steps 11 - 12**.

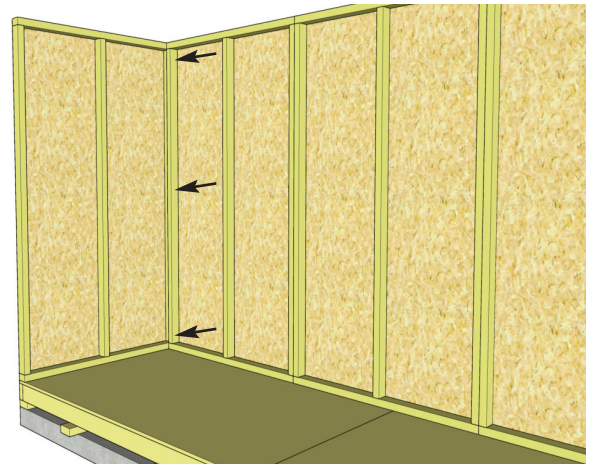
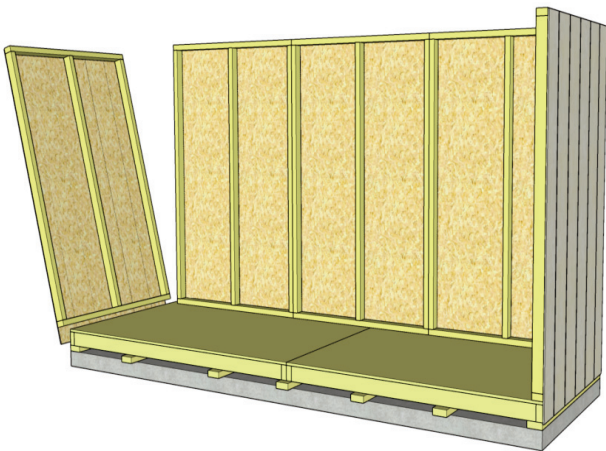

13. Complete remaining side wall attachment as per **Steps 11 - 12**.

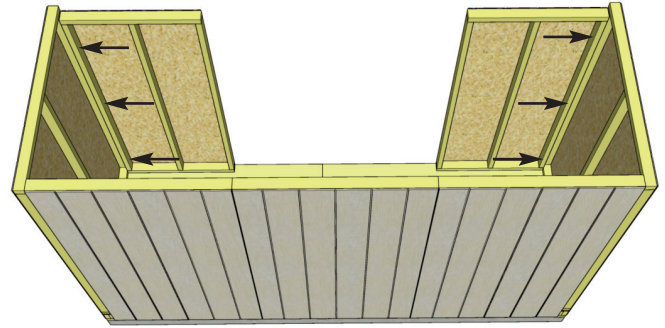
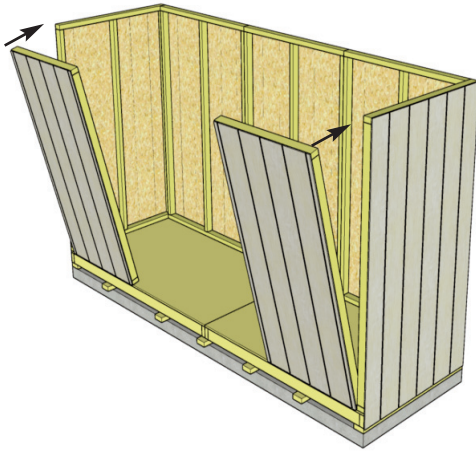

14. Carefully lay down Front Wall Panels face down. Position and attach Front Bottom Wall Plates to bottom of wall studs of 8. Complete each wall panel with 3 - 2 1/2" screws as per Step 8. Place Front Walls so wall framing is flush with floor. Attach each wall panel with 3 - 2 1/2" screws per panel as per Steps 11-13.

Parts
Side/Rear Wall Panels
 (35" wide x 75" high) x 2
Bottom Wall Plates
 (1 5/8" x 2 1/2" x 35") x 5

Hardware
S1 - 2 1/2" Screws
 x 12 total

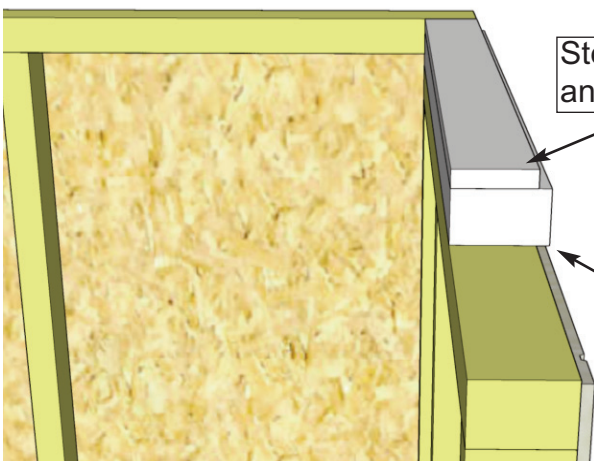

Step to front and top.

Align flush outside with wall siding.

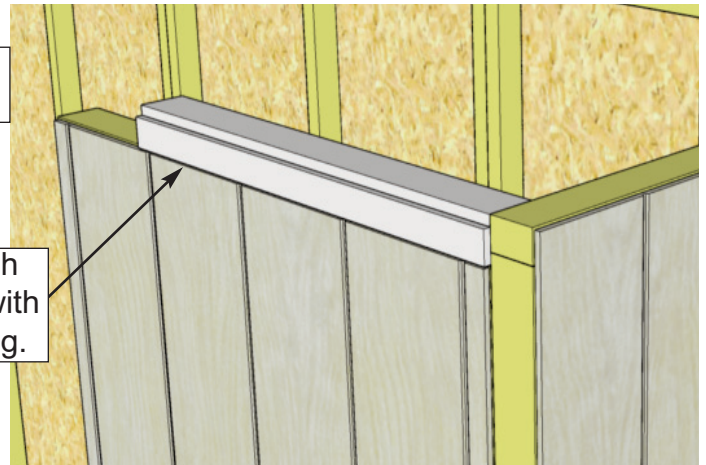

15. Position **Door Header - Short** on top of front wall framing so it is flush on the inside with 2x3 wall stud. Attach by screwing down into top wall framing with 3 - 3" **Screws**. Complete both sides.

Parts
Door Header - Short
 (2" x 2 7/8" x 26 1/4") x 2

Hardware
S4 - 3" Screws
 x 6 total

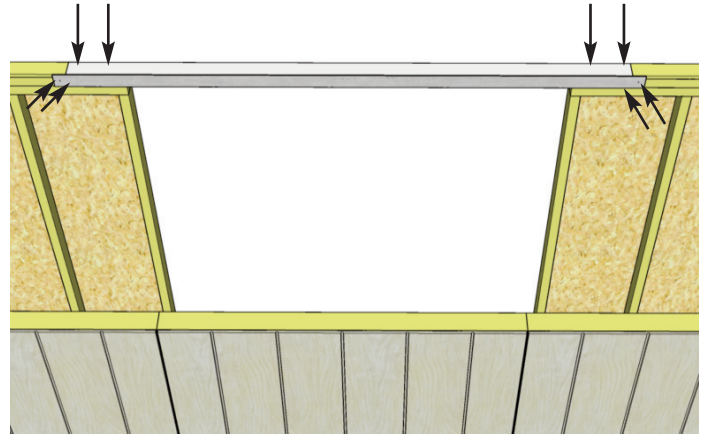
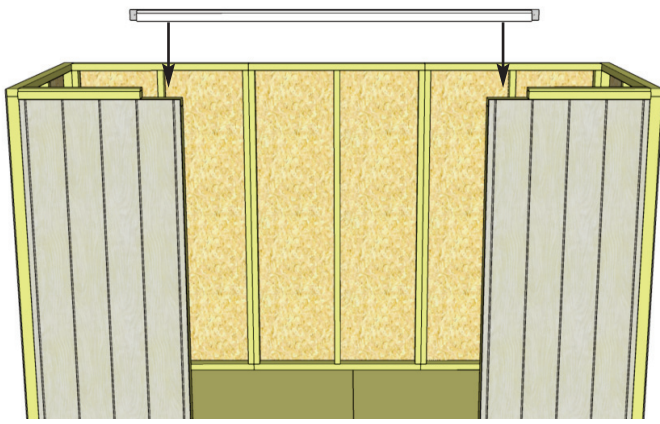

16. Position and attach **Door Header - Long** between short door headers. The Long Door Header has an aluminum strip attached to the back for added support. Attach by screwing down into wall framing with **2 - 3" Screws** per side. Fasten Aluminum strip to short headers with **2 - 1 1/4" Screws** per side.

Parts
Door Header - Long
 (2" x 2 7/8" x 84") x 1

Hardware
S4 - 3" Screws x 4 total
S2 - 1 1/4" Screws x 4 total

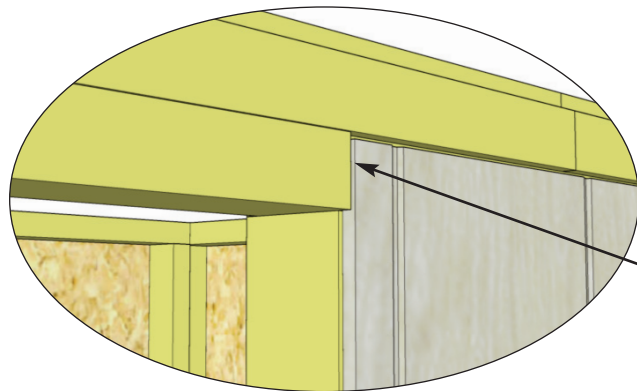

Interior Door Header flush with wall siding.

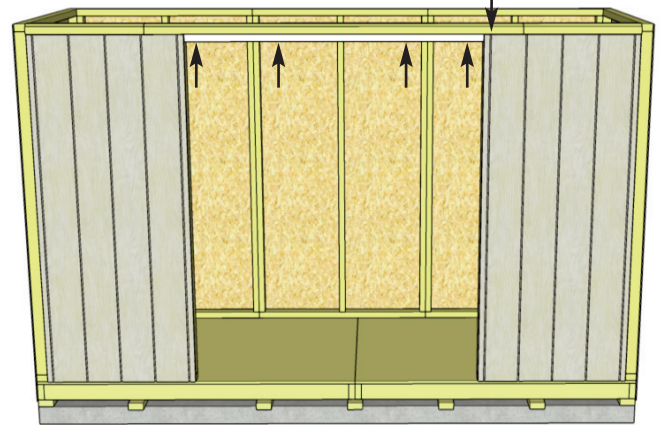
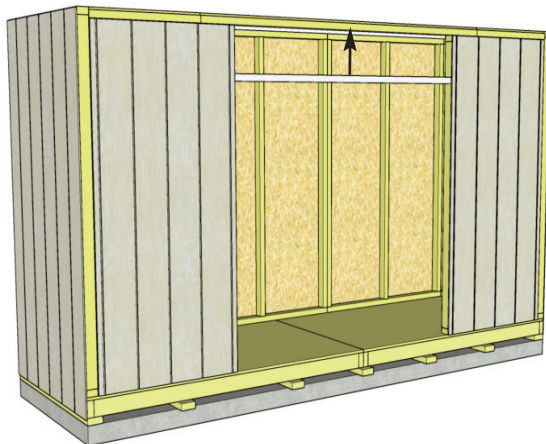

17. Attach Interior Door Header as shown above. Align with front wall siding. Attach with **4 - 2 1/2" Screws** to underside of Door Header.

Parts
Interior Door Header
 (1 1/2" x 2 7/8" x 66 1/2") x 1

Hardware
S1 - 2 1/2" Screws x 4 total

Advice: Prior to fastening walls to floor and installing rafters, take time to confirm your walls are level, square and plumb. Measure diagonal at top and bottom of walls inside corner-to-corner. This should be approximately 142 3/8". More importantly if measurement are not within 1/4", your walls are not square. Adjusting now will make it easier to install roof section.

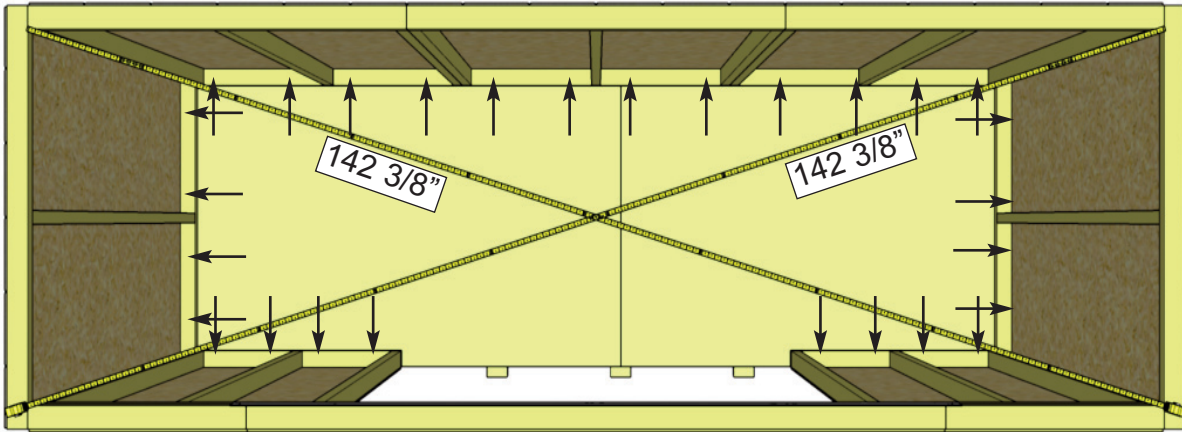

18. When all walls are attached together, check alignment with floor. Bottom of wall frames should sit flush with outside of floor framing, with siding overhanging by approximately 4 1/2". Confirm 66 1/2" wide door opening at bottom. When positioned correctly, fasten Bottom Wall Plates to floor using **4 - 2 1/2" Screws** per wall panel.

Hardware
S1 - 2 1/2" Screws
 x 28 total

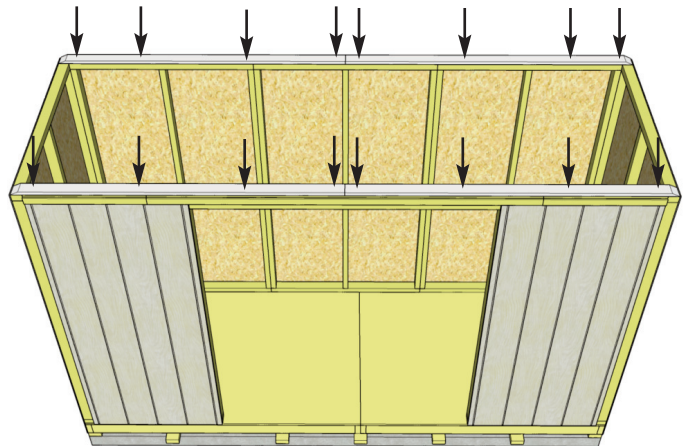
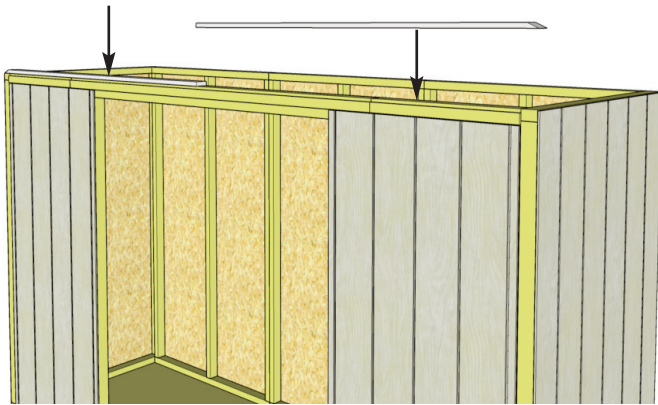

19. Locate Front/Rear Top Plates and position on top of wall framing. Top Plates are angle cut on one end. Together the plates should be centered evenly on the wall left to right. Attach by screwing each piece down with **4 - 2" Screws** per piece. Complete both Front & Rear.

Parts
Front/Rear Top Plates
 (3/4" x 2 1/2" x 70 3/4") x 4

Hardware
S3 - 2" Screws x 16 total

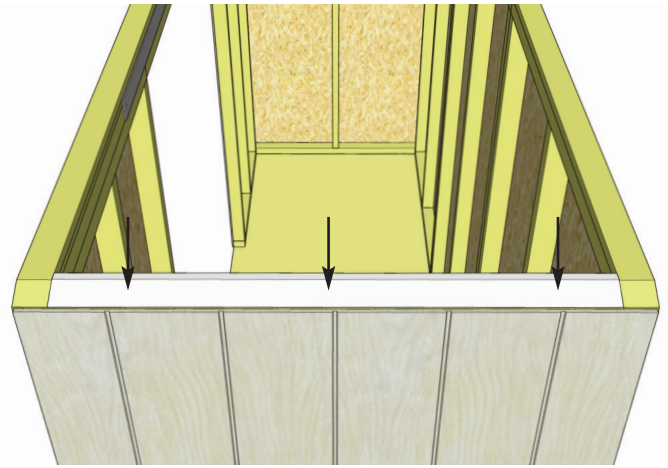
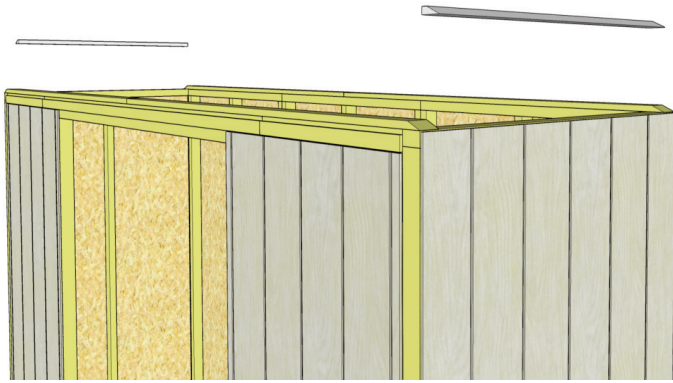

20. Locate Side Top Plates and position on top of wall framing between Front/Rear Top Plates. Side Top Plates are angle cut on one edge. Attach by screwing each piece down with **3 - 2" Screws** per piece. Complete both Sides.

Parts
Side Top Plates
 (3/4" x 2 1/2" x 40 1/2") x 2

Hardware
S3 - 2" Screws x 6 total

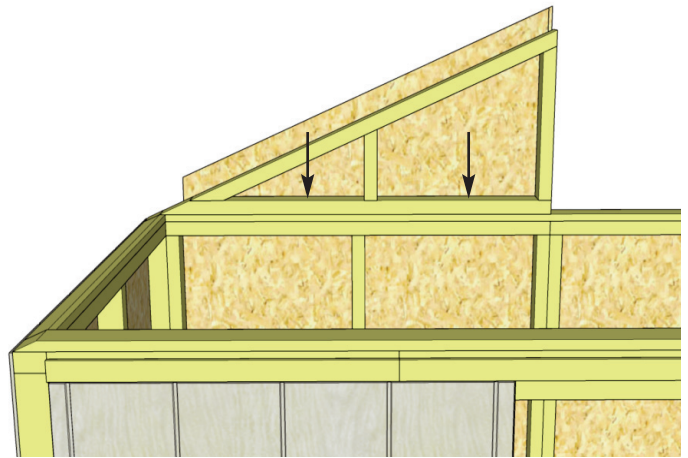
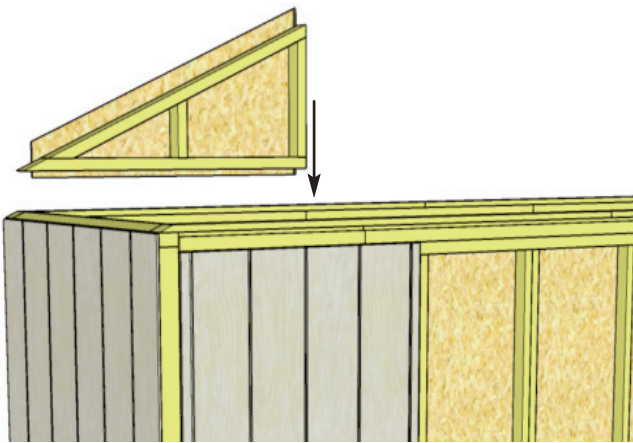

21. Locate Triangular Side Gable and position on top of rear wall framing. Angles should match up between gable and Front/Rear Top Plates. Temporarily attach with **2 - 2" Screws** to hold in place.

Parts
Triangular Gable
 (3/4" x 2 1/2" x 40 1/2") x 1

Hardware
S3 - 2" Screws x 2 total

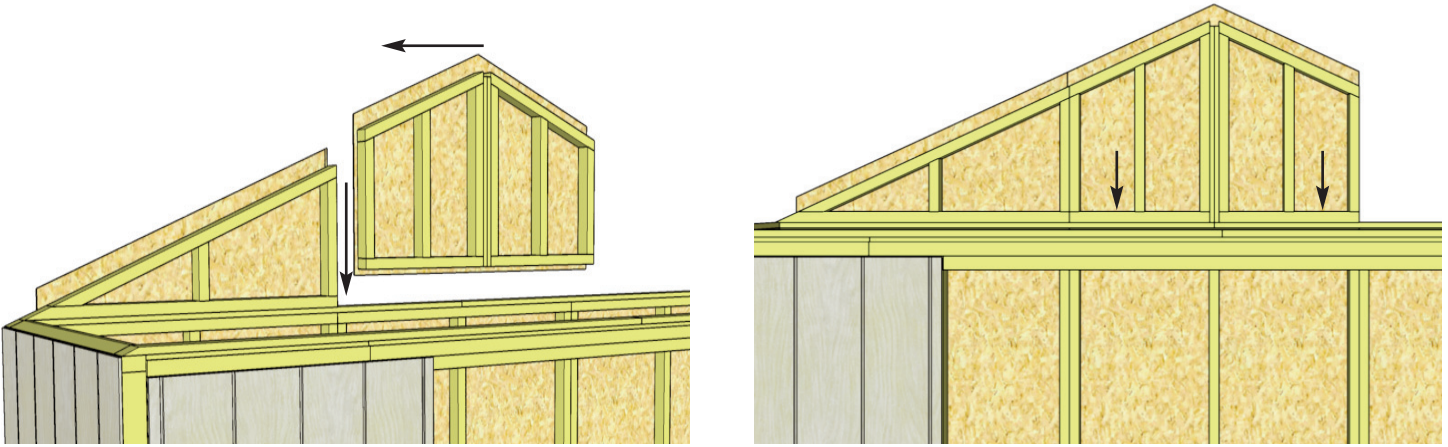

22. Locate Pentagon Gable and position next to previous gable panel. Angles should match up between gable and Front/Rear Top Plates. Temporarily attach with **2 - 2" Screws** to hold in place.

<u>Parts</u> Pentagon Gable (45 1/2" X 31 1/2") x 1
--

<u>Hardware</u> S3 - 2" Screws x 2 total
--

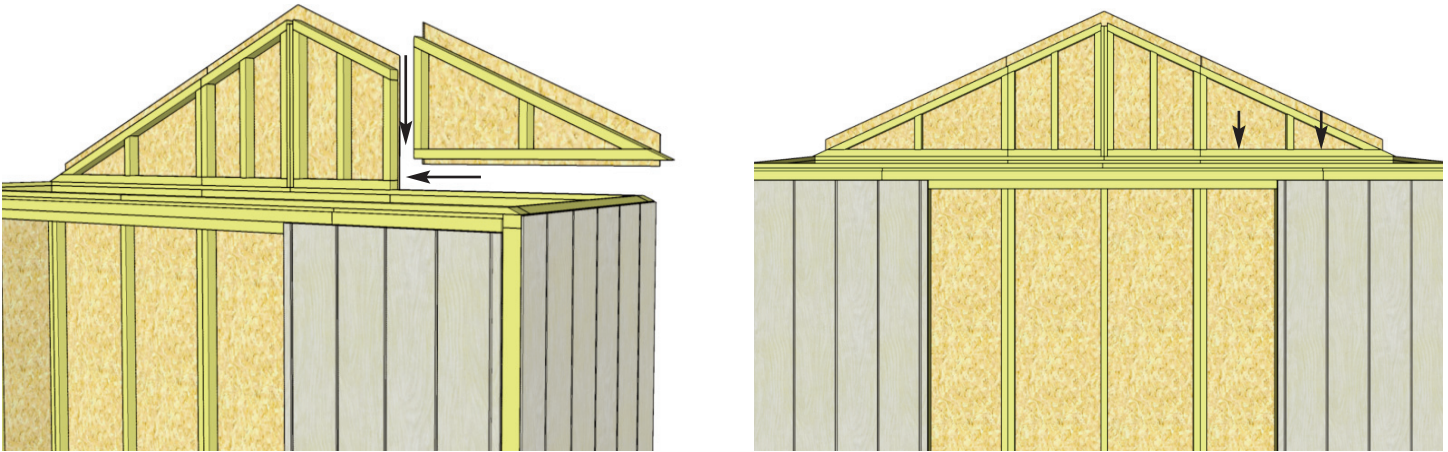

23. Locate second Triangular Side Gable and position next to previous gable panel. Angles should match up between gable and Front/Rear Top Plates. Temporarily attach with **2 - 2" Screws** to hold in place.

<u>Parts</u> Triangular Gable (3/4" x 2 1/2" x 40 1/2") x 1
--

<u>Hardware</u> S3 - 2" Screws x 2 total
--

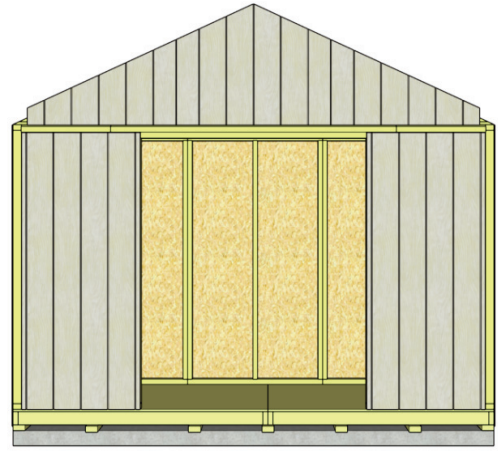
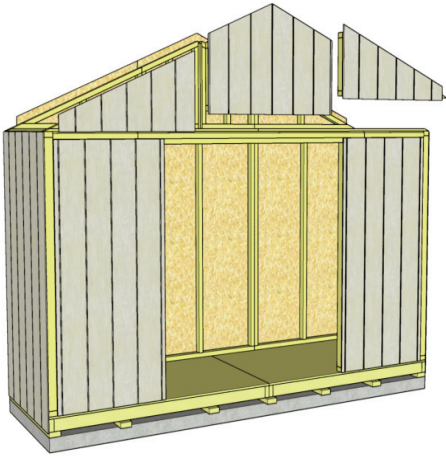

24. Repeat **Steps 21-23** to position and attach remaining gable panels to front of shed.

Parts
Triangular Gable
 (3/4" x 2 1/2" x 40 1/2") x 1

Hardware
S3 - 2" Screws x 2 total

3. Rafter Section

Exploded view of all parts necessary to complete the Rafter Section. Identify all parts prior to starting.

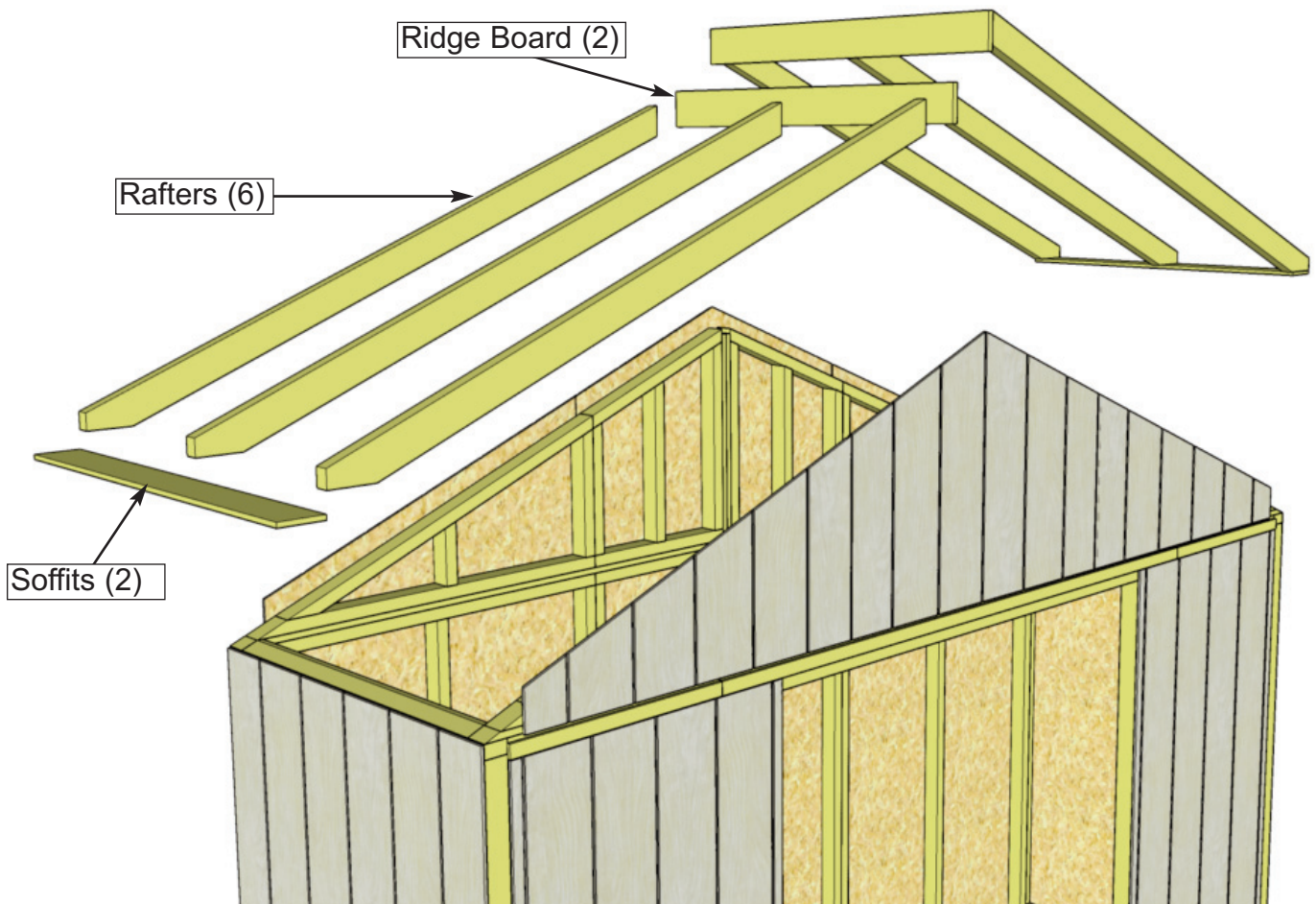

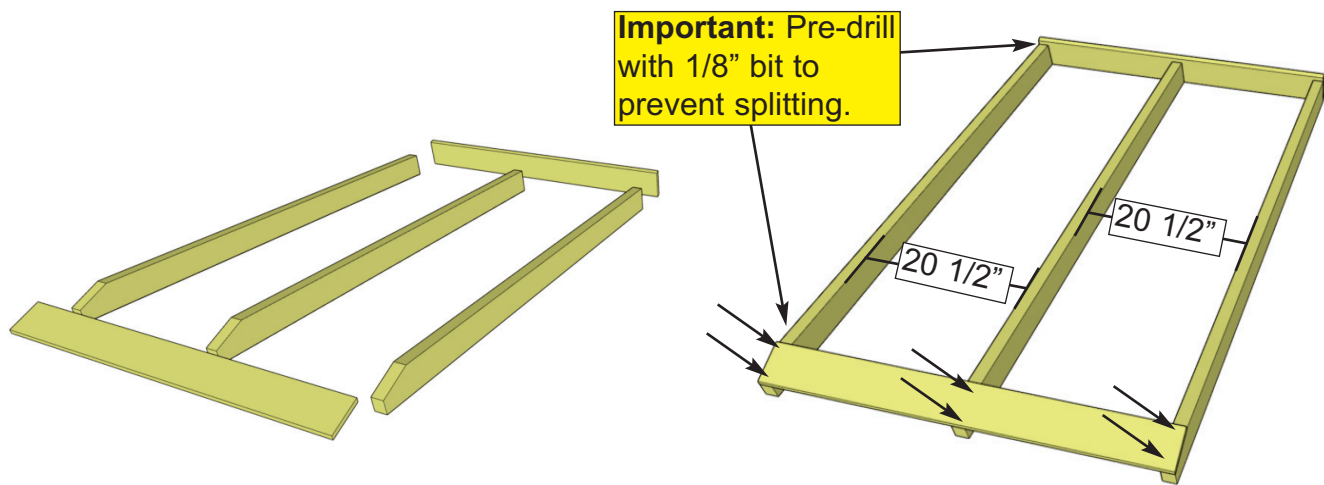

25. Locate 1 **Ridge Board**, 1 **Soffit** and 3 **Rafters**. Lay out on level ground as shown above. When assembling Rafter section it is important to pre-drill the soffit and ridge board connections before screwing together. Attach Soffit Boards flush to end of outside rafters. Attach soffits with **2 - 2 1/2" Screws** per rafter end. Attach Ridge Board to Rafters with **2 - 2" Screws** per Rafter end. Complete both sections.

Parts	
Ridge Board	(3/4" x 4 1/2" x 45 1/2") x 2
Rafters	(1 1/2" x 3 1/2" x 80 7/8") x 6
Soffit	(1/2" x 4 1/2" x 45 1/2") x 2

Hardware

S1 - 2 1/2" Screws x 12 total

S3 - 2" Screws x 12 total

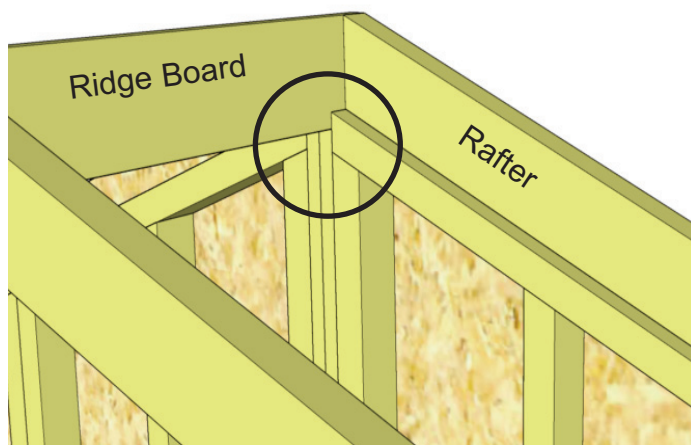

26. Flip Rafter section over and left up onto Gable Framing. Slide Rafter section up until bottom of Ridge Board slips into Gable notch. Soffit will sit approximately an 1/8" away from wall panel.

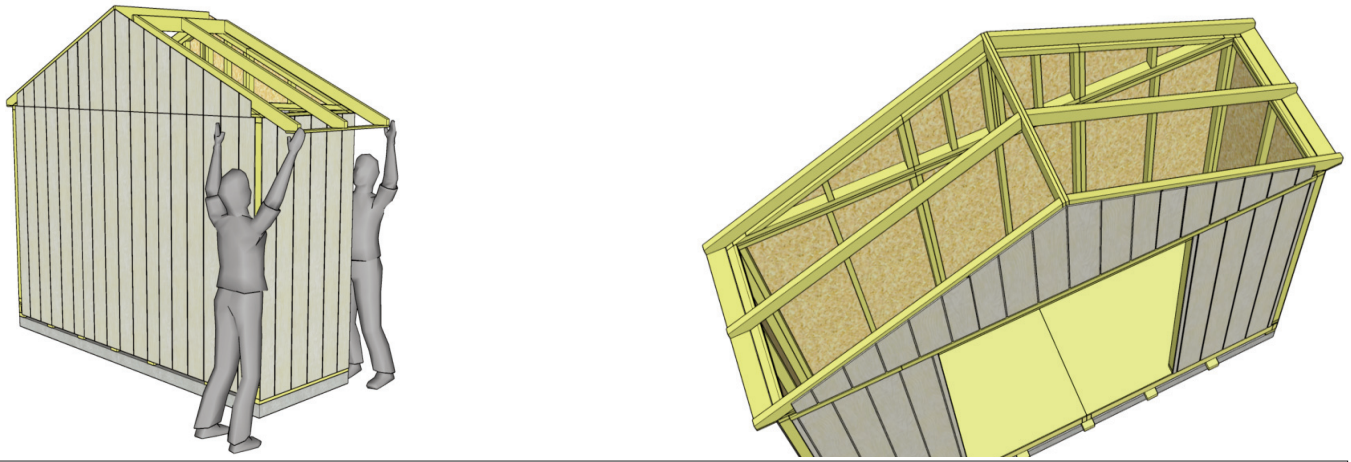

27. Place second completed Rafter section onto Gable Framing as per **Step 26.**

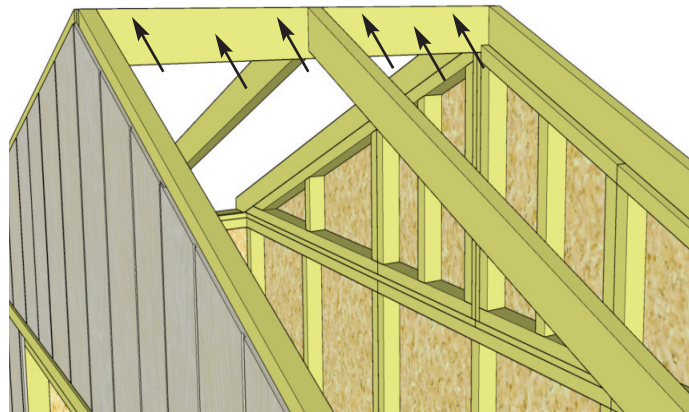

28. At the peak, align **Ridge Boards** so they are flush together and secure them with **12 - 1 1/4" Screws**. **Important:** If there is a gap between Ridge Boards, try pushing side walls closer together from outside. Side walls should be 136 1/2" apart from inside of wall plate to wall plate.

Hardware

S2 - 1 1/4" Screws x 12 total

Important: If Gable framing does not line up with Rafter, remove temporary 2" Screws from Gable framing. Re-align gable and secure with **26 - 2" Screws** per side.

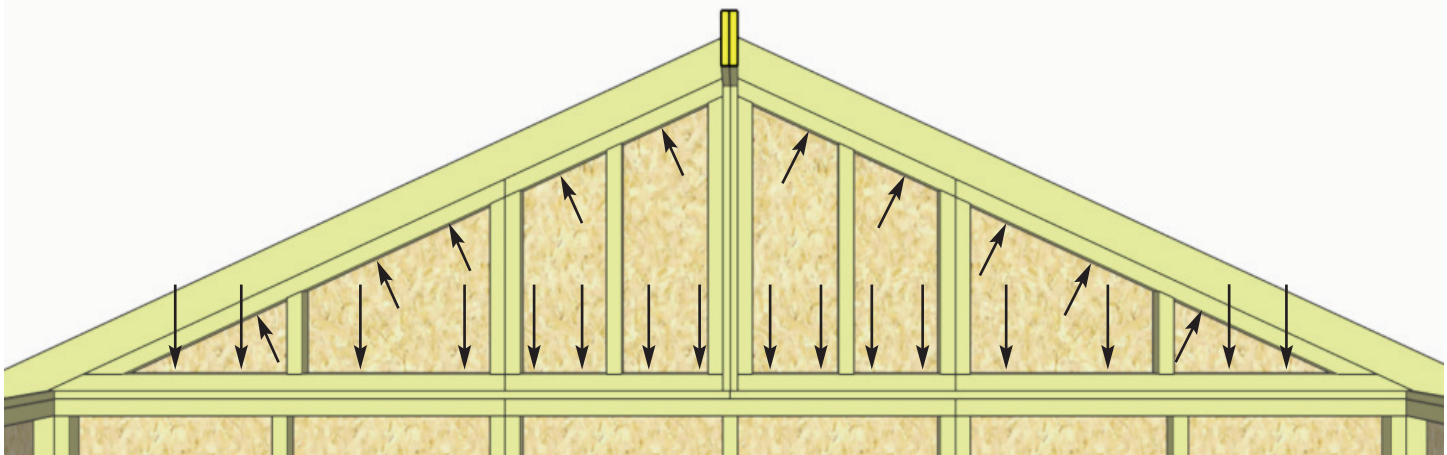

29. With both **Ridge Boards** connected, completely secure Rafters to Gable framing of each Gable wall. Use **26 - 2" Screws** per Gable. Complete both sides.

Hardware

S3 - 2" Screws x 52 total

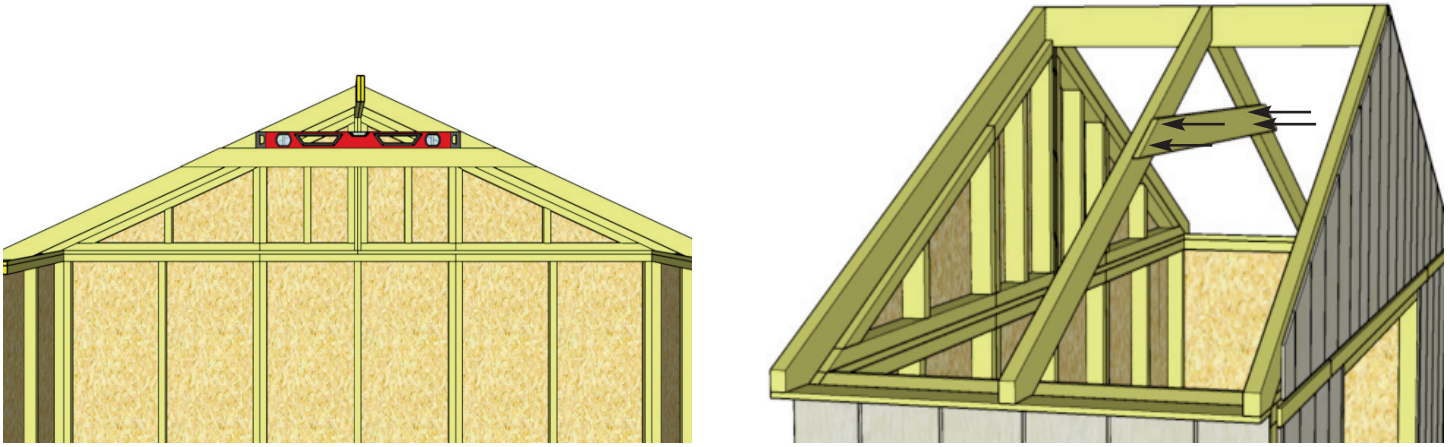

30. Locate Roof Gusset and position on middle rafters. Use a level to square the Gusset and attach with **4 - 2" Screws**.

<u>Parts</u> Gusset (3/4" x 3 1/2" x 75") x 1	<u>Hardware</u> S3 - 2" Screws x 4 total
--	---

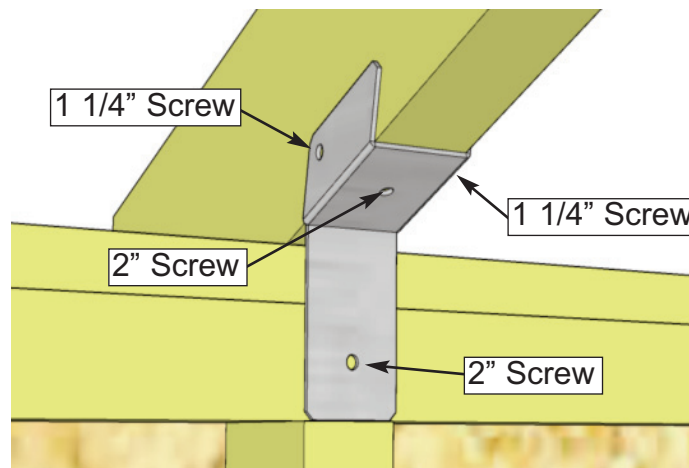

31. Attach Single Rafter Brackets where Rafters and Top Wall Plates meet inside of shed. Attach with **2 - 1 1/4" Screws** and **2 - 2" Screws** per bracket. Attach bracket to center Rafter on each side.

<u>Hardware</u> S3 - 2" Screws x 4 total S2 - 1 1/4" Screws x 4 total	<u>Hardware</u> Y30 - Single Rafter Bracket x 2 total
---	--

4. Roof Section

Exploded view of all parts necessary to complete the Roof Section. Identify all parts prior to starting.

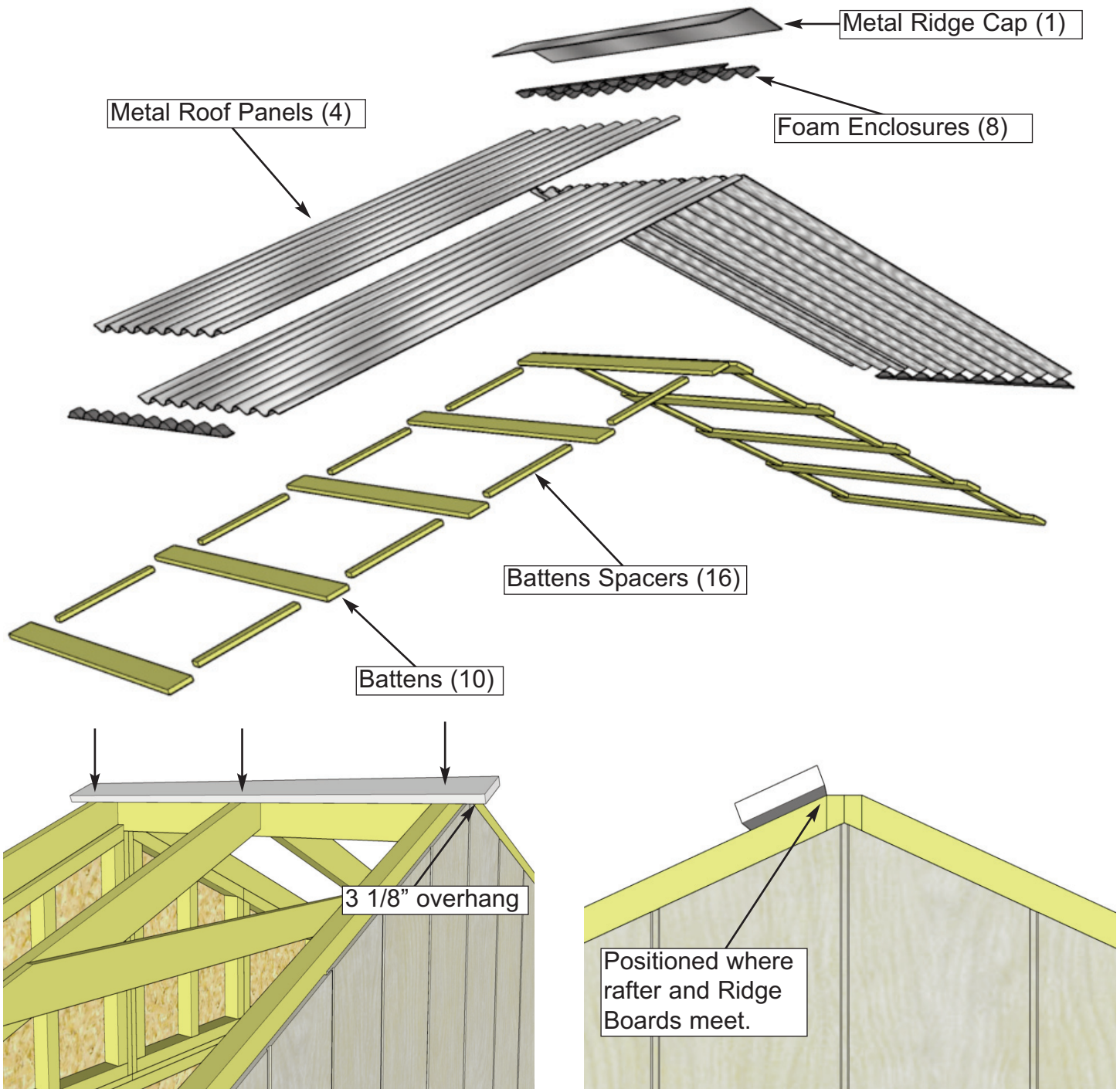

32. Locate a **Roof Batten** and position of roof. Place at top of Rafter section where Rafter and Ridge Boards meet. Batten will overhang outside Rafters by 3 1/8". Fasten Batten to Rafters with **3 - 1 1/4" Screws**.

<p>Parts Roof Battens (3/4" x 3 1/2" x 51 3/4") x 1</p>
<p>Hardware S2 - 1 1/4" Screws x 3 total</p>

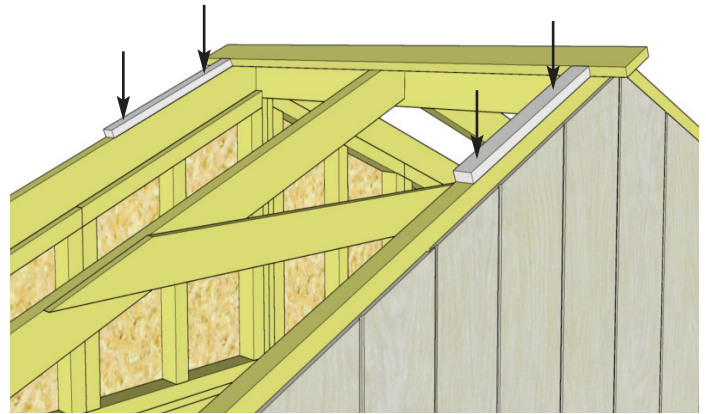
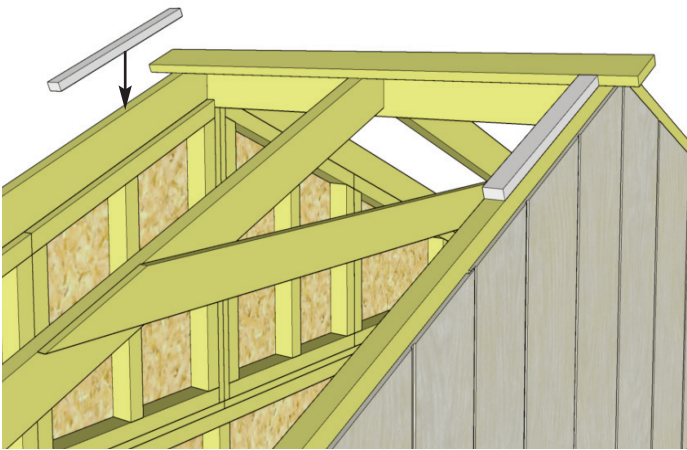

33. Locate two **Batten Spacers** and position on outside Rafters flush with Roof Batten. Batten Spacers allow you to line up the next row of Battens. Attach each Batten Spacer with **2 - 1 1/4" Screws**.

<u>Parts</u>
Batten Spacers (3/4" x 1 1/2" x 15 3/4") x 2
<u>Hardware</u>
S2 - 1 1/4" Screws x 4 total

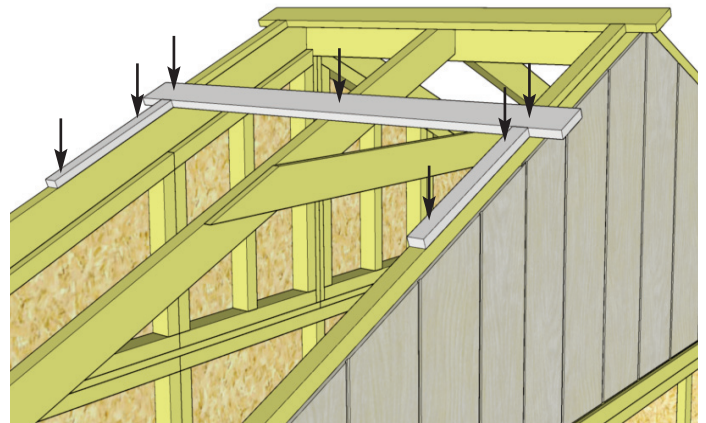
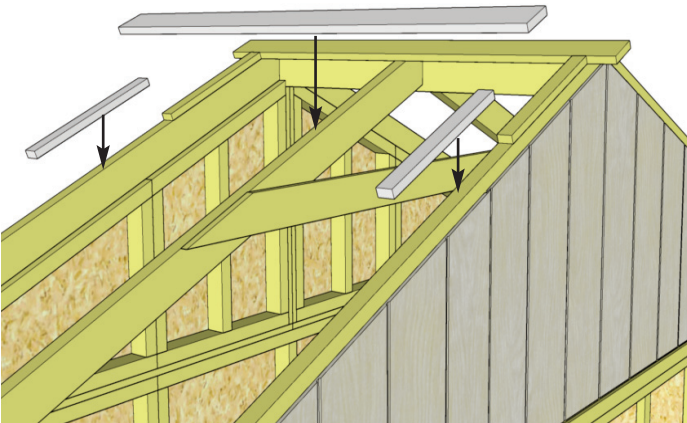

34. Locate two more **Batten Spacers** and one **Roof Batten**, position on Rafters flush and fasten as per **Steps 32 - 33**.

<u>Parts</u>
Roof Battens (3/4" x 1 1/2" x 15 3/4") x 1
Batten Spacers (3/4" x 1 1/2" x 15 3/4") x 2

<u>Hardware</u>
S2 - 1 1/4" Screws x 4 total

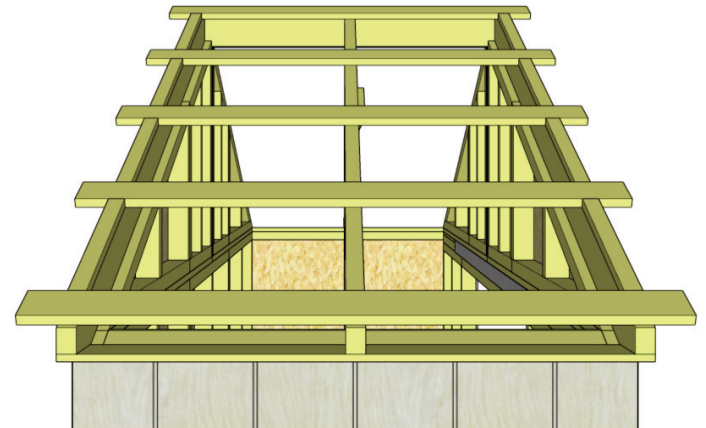
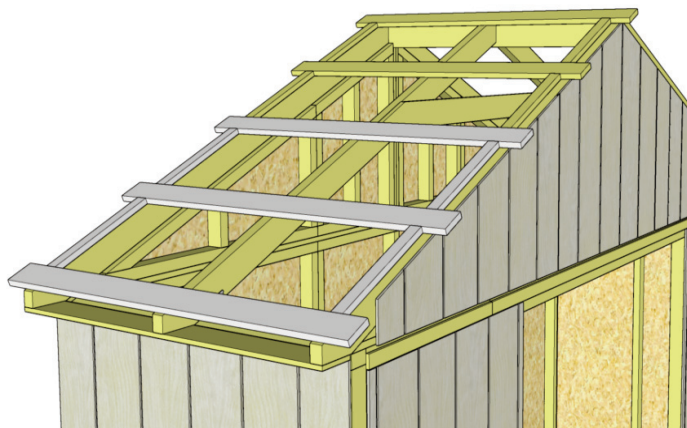

35. Locate four **Batten Spacers** and three **Roof Battens**, to complete the first half of the roof, fastening as per **Steps 32 - 33**.

<u>Parts</u>
Roof Battens (3/4" x 1 1/2" x 15 3/4") x 3
Batten Spacers (3/4" x 1 1/2" x 15 3/4") x 4

<u>Hardware</u>
S2 - 1 1/4" Screws x 17 total

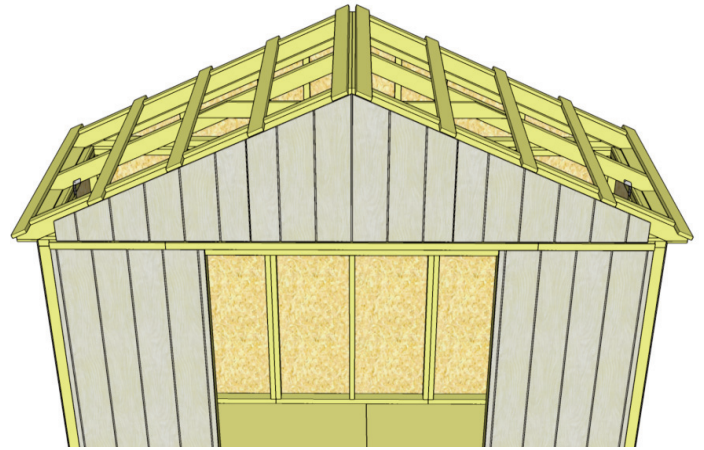
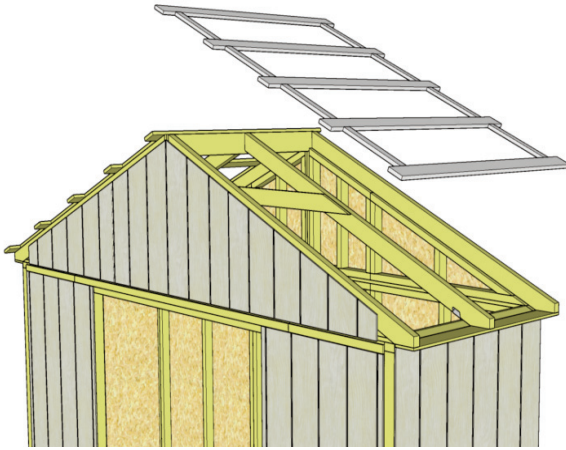

36. Repeat **Steps 32 - 35** to complete opposite side of roof.

Hardware

S2 - 1 1/4" Screws x 31 total

Parts

Roof Battens

(3/4" x 1 1/2" x 15 3/4") x 5

Batten Spacers

(3/4" x 1 1/2" x 15 3/4") x 8

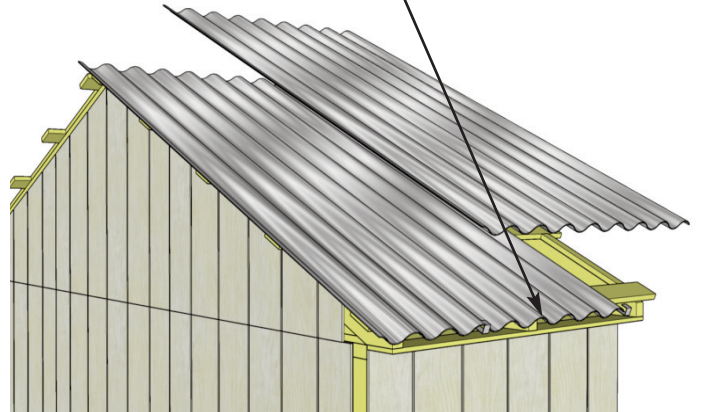
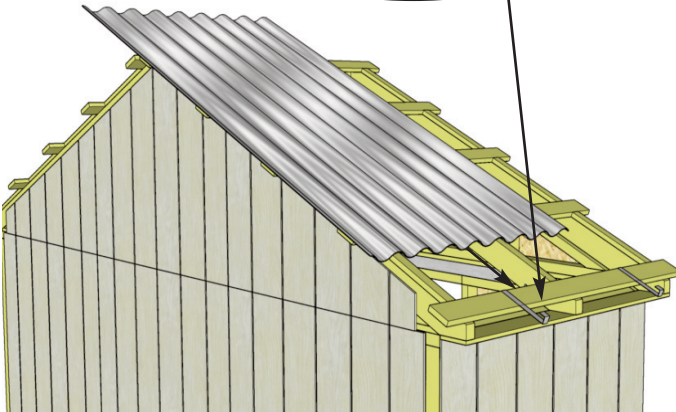
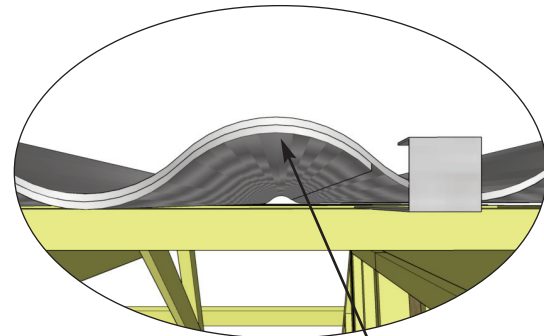
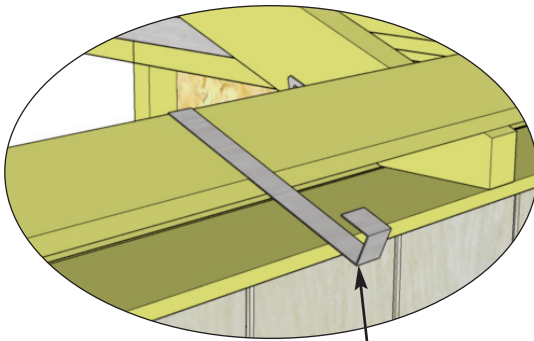

37. Locate two **Metal Roof Panels** and two **Metal Roof Hangers**.

To temporarily hold the Metal Roof Panels in place, hook a Metal Roof Hanger onto the lowest Batten, approximately where the center of the panels will lie. Place first Metal Roof Panel on Battens and into Hanger. Do not fasten panels down until **Step 42**. Place remaining panel and hanger on the same way. Metal Roof Panels will overlap in the center.

Parts

Metal Roof Panels

(39"wide x 86"long) x 4

Hardware

Y38 - Metal Roof Hangers

x 2 total

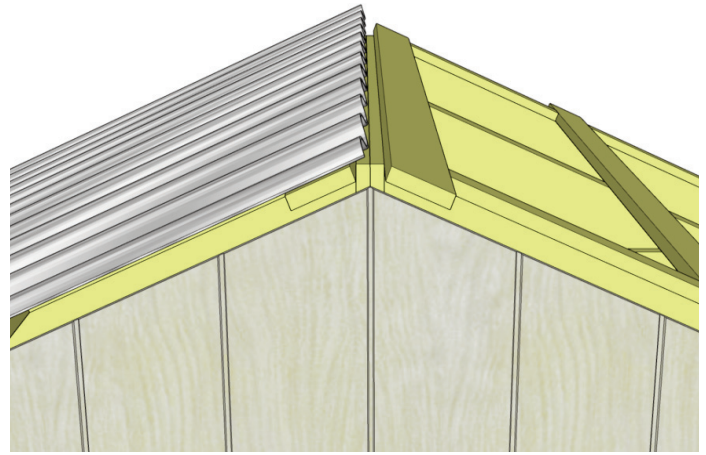
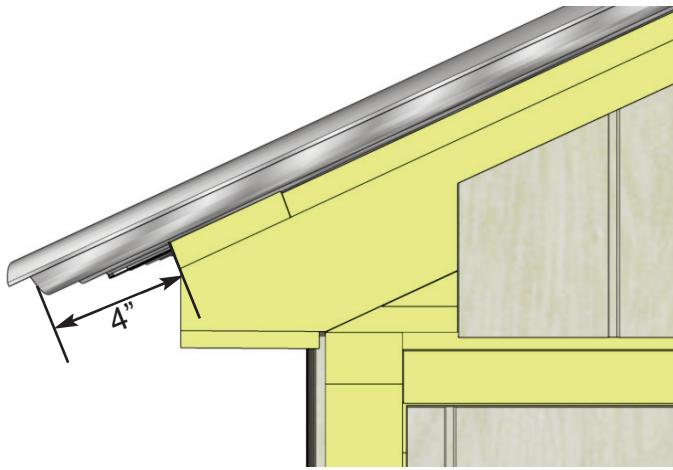

38. Adjust Panels side-to-side to achieve desired width. Overall width past the Battens can vary from 1" - 3" depending on your preference. The overhang over the side of the shed will be set by the Metal Roof Hangers, but should be approximately 4" on sides.

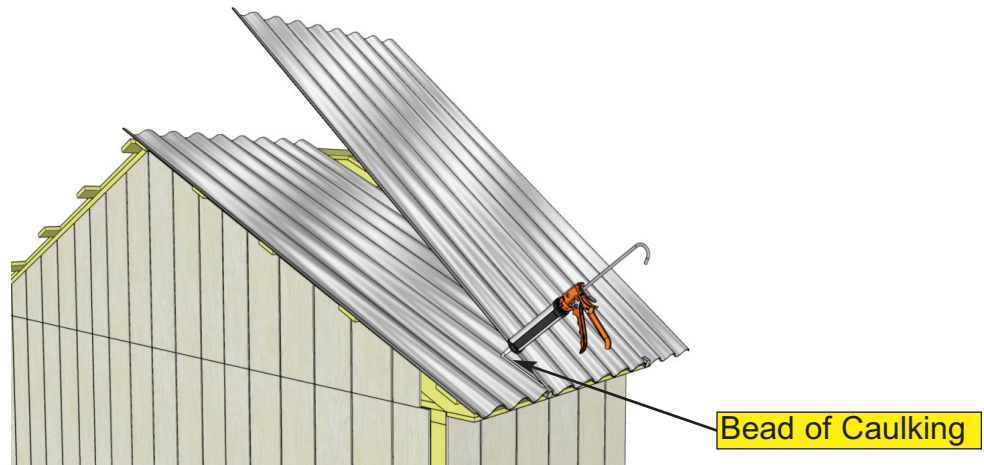

39. Once the Metal Roof Panels are spaced correctly from side-to-side and top-to-bottom, lift 1 panel up and run a bead of caulking down the overlapping seams of each panel to seal the joints, Place panel down once seam is caulked. You will likely need assistance for this step.

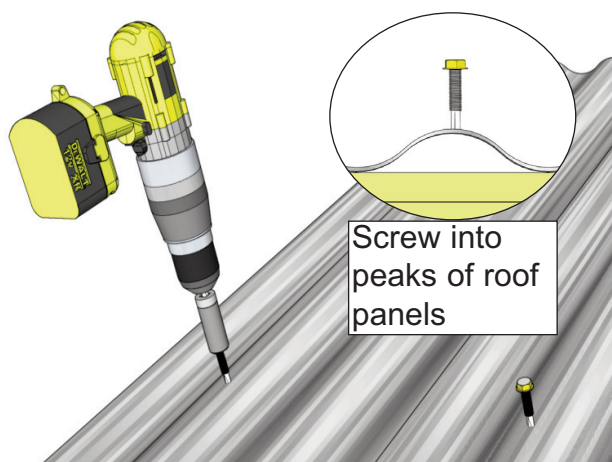

Screw into center of Roof Battens in the middle row.

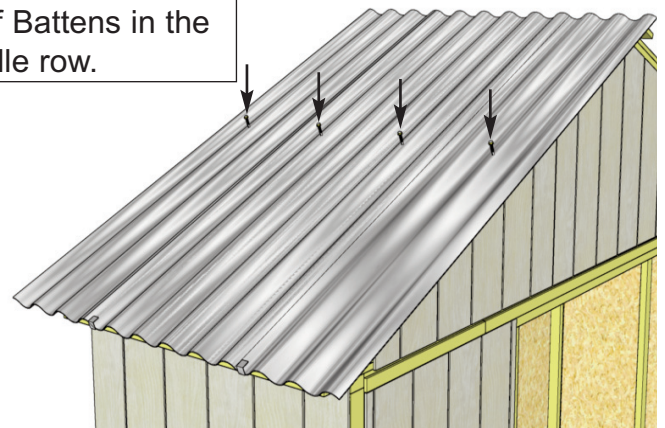

40. Using 4 - 2" Metal Roof Screws and 1/4" Nut Driver (included), partially secure Metal Roof Panels to middle Roof Batten. Only fasten screw halfway so that Metal Roof Hangers can be removed in Step 41. Metal screw is self-tapping, do not overtighten. Screw into center of Roof Batten.

Hardware
2" Metal Roof Screws
 x 4 total

Important: Remove Metal Roof Hangers

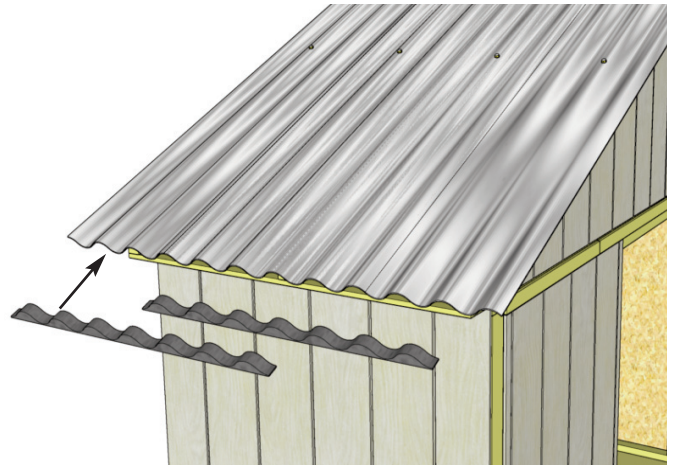
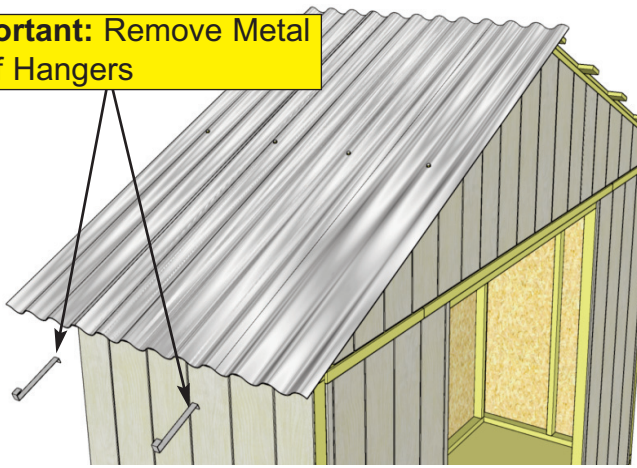

41. Before fully fastening **Metal Roof Panels** down, remove **Metal Roof Hangers** and insert **Foam Enclosures** between **Metal Roof Panels** and **Roof Battens** at the bottom of roof. **Foam Enclosures** will prevent moisture and pests from entering your shed through here. Trim one down if necessary.

Parts
Foam Enclosures
x 2 total

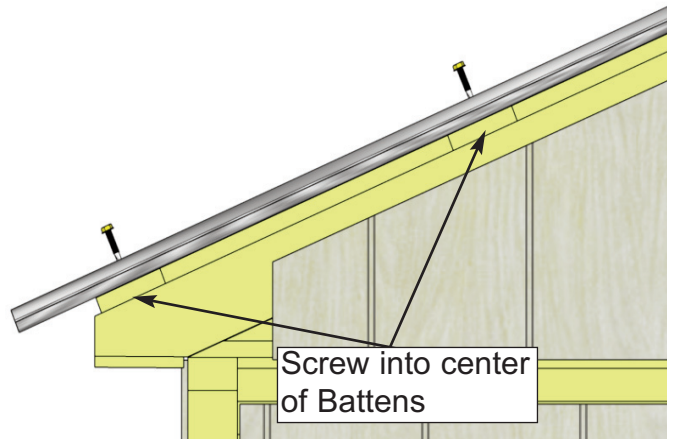
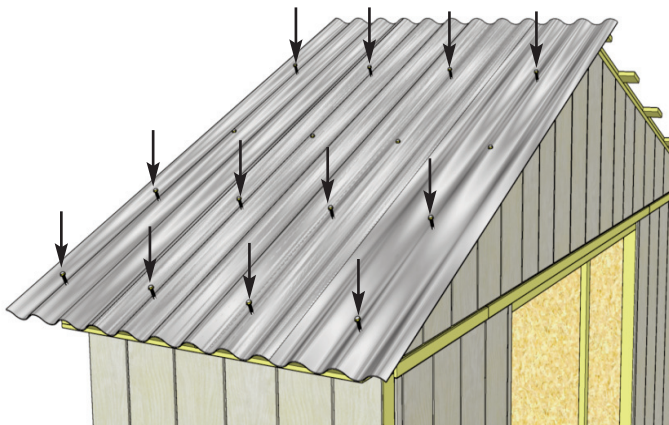

42. Using **12 - 2" Metal Roof Screws** and **1/4" Nut Driver**, secure **Metal Roof Panels** down to lower 4 rows of **Roof Battens**. Leave the top row unsecured for now to secure **Ridge Caps** later in **Step 45**. Tighten screws in middle row that were partially secured in **Step 40**. Do not overtighten!

Hardware
2" - Metal Roof Screws
x 12 total

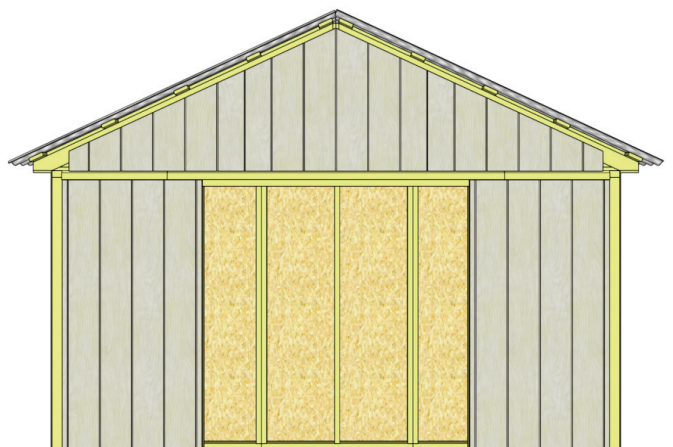
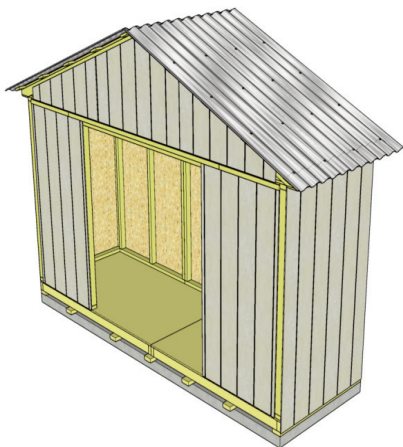

43. Repeat **Steps 37 - 42** to complete opposite side of metal roof.

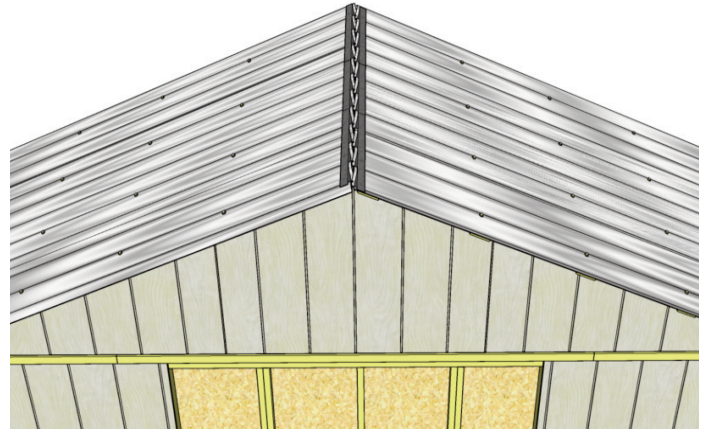
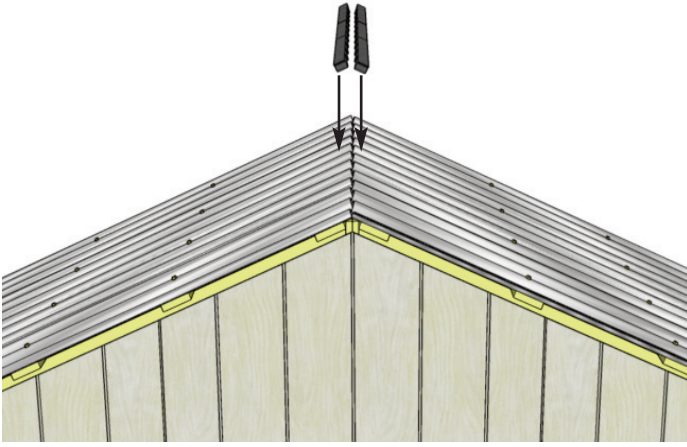

44. Locate remaining **Foam Enclosures**. Place **Foam Enclosures** at the top of Roof Panels. **Foam Enclosures** prevent moisture from coming in the top of your shed.

Parts
Foam Enclosures
 x 4 total

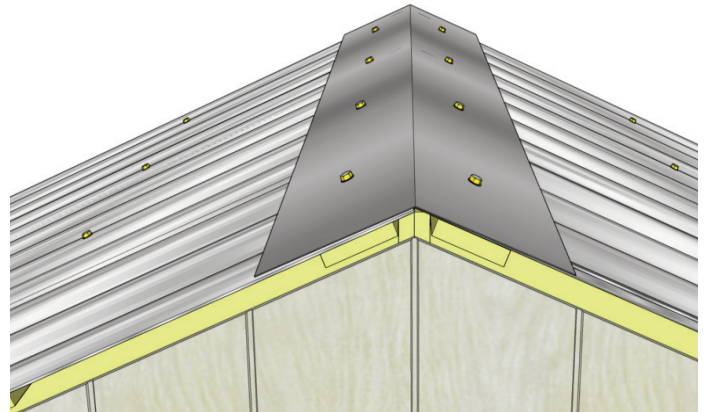
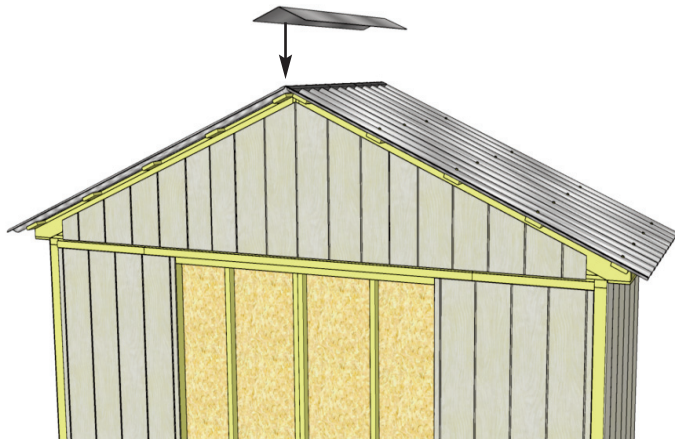

45. Place **Metal Ridge Cap** onto apex of roof. Center Ridge Cap on roof and secure with **8 - 2" Metal Roof Screws** (4 per side). Screw into center of top most **Roof Batten**. Do not overtighten!

Parts
Metal Ridge Cap
 (60"long) x 1

Hardware
2" Metal Roof Screws
 x 8 total

5. Trim & Miscellaneous Section

Exploded view of all parts necessary to complete the Skirting, Trim, Facia and Miscellaneous Pieces. Identify all parts prior to starting.

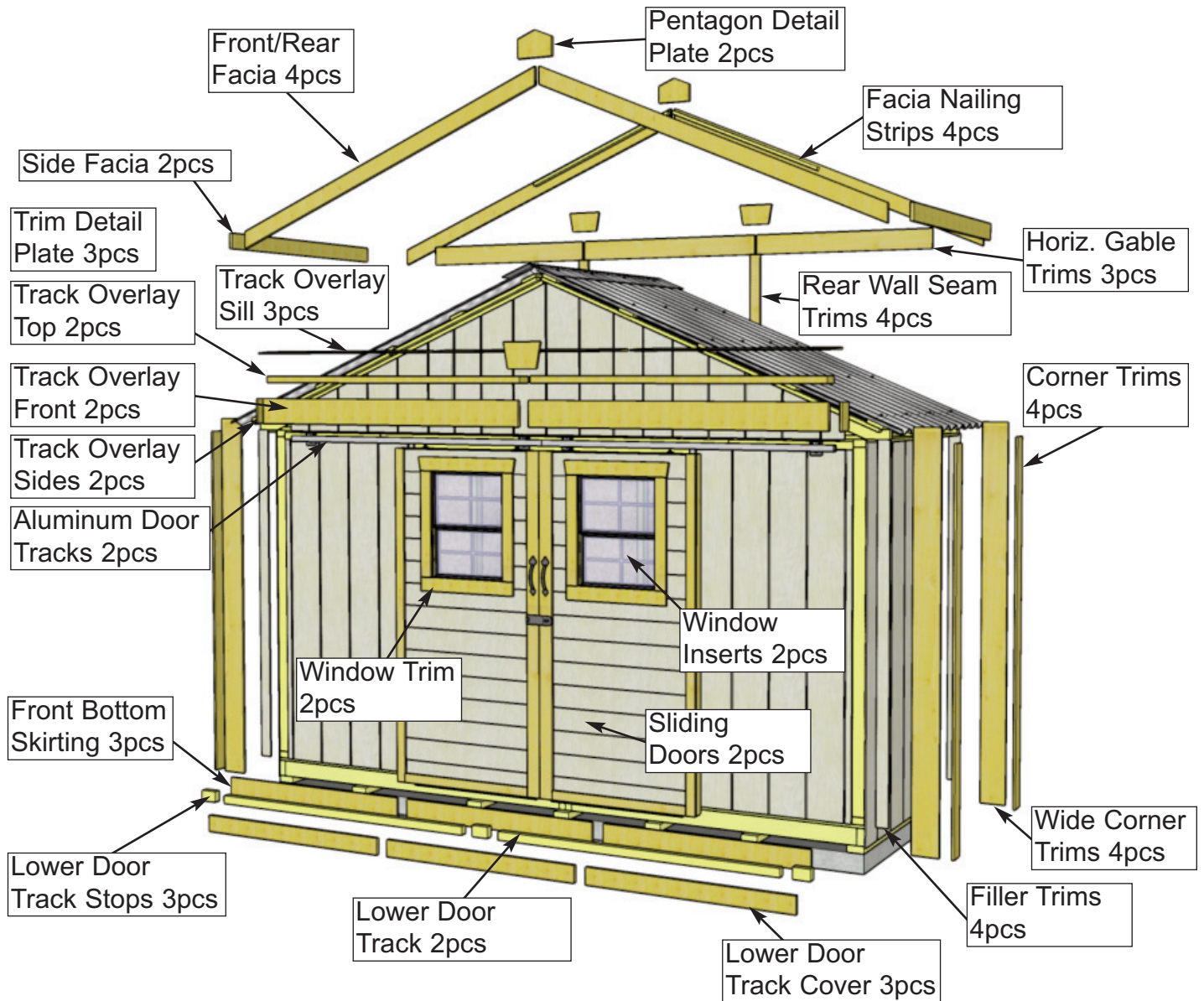

Note: All Trim, Facia, and Bottom Skirting pieces will be positioned rough face out when installed.

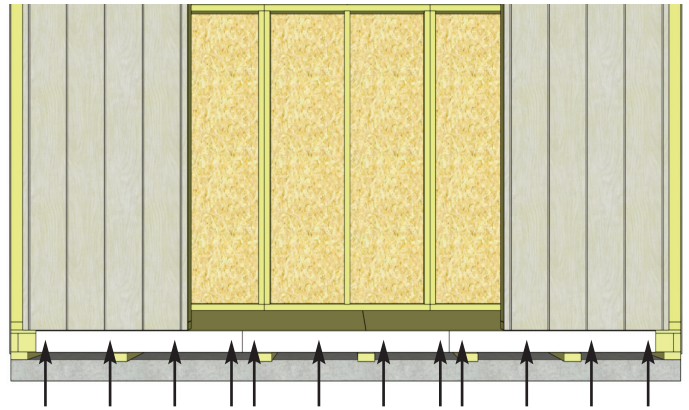
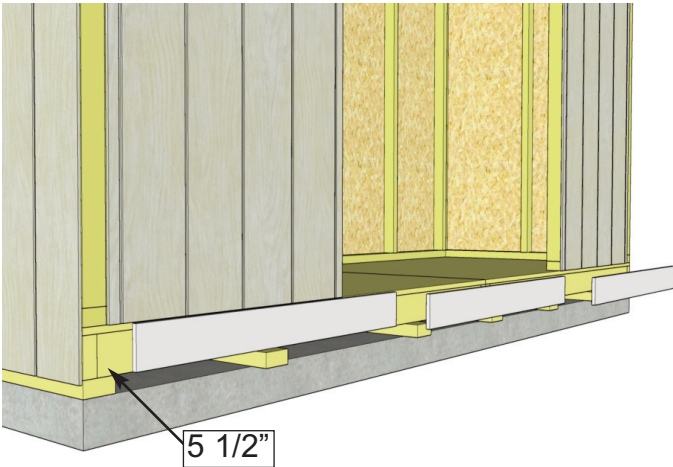

46. Locate Front Bottom Skirting and position on floor frames 5 1/2" from the side. Attach each piece with **4 - 1 1/2" Finishing Nails**.

<u>Parts</u> Front Bottom Skirting (1/2" x 4" x 43 1/2") x 3	<u>Hardware</u> N1 - 4 1/2" Finishing Nails x 12 total
---	---

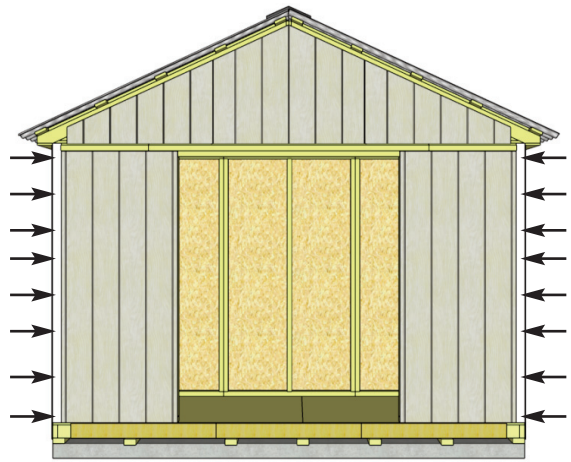
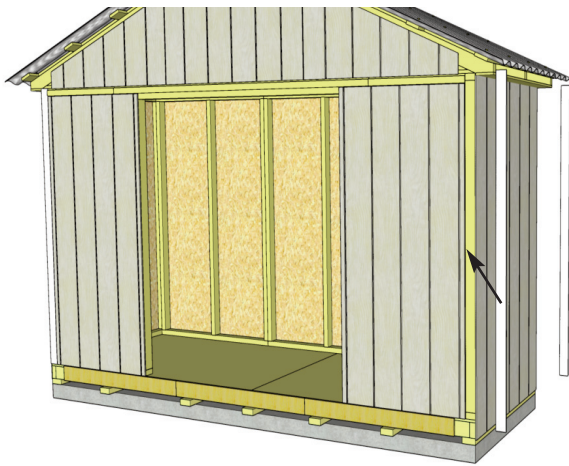

47. Locate **Filler Trims** and position over exposed wall framing on the front and rear of your shed. Filler Trims won't be visible, they serve as a backing for Corner Trims later. Attach with **8 - 1 1/2" Finishing Nails** per piece.

<u>Parts</u> Filler Trims (3/8" x 2 1/2" x 75") x 4	<u>Hardware</u> N1 - 4 1/2" Finishing Nails x 32 total
--	---

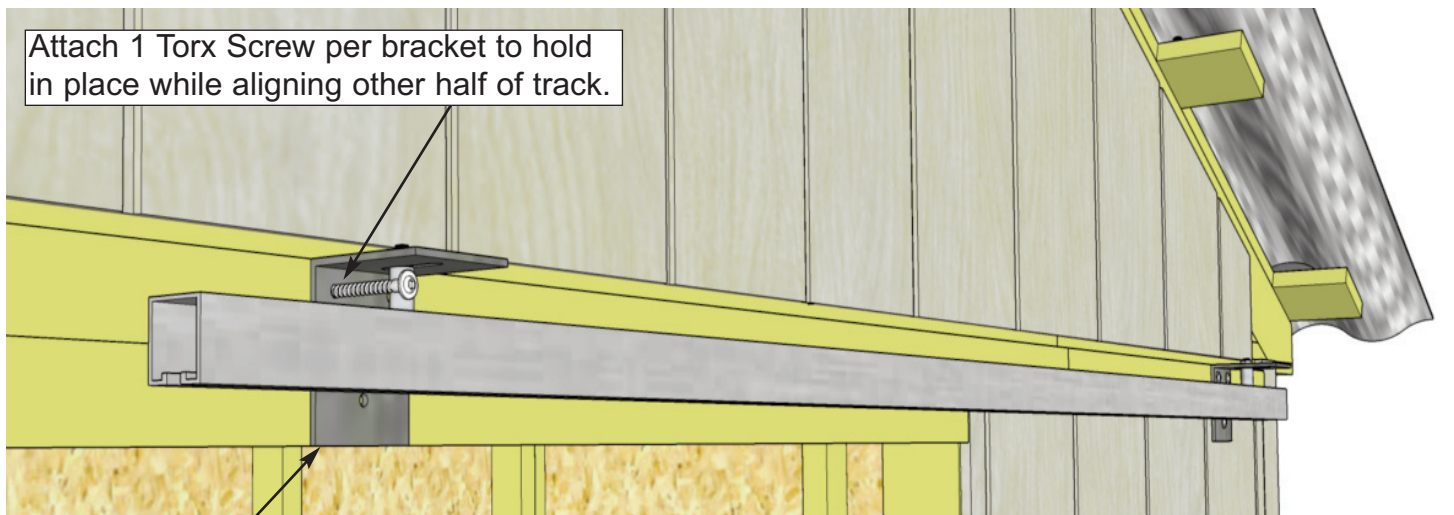
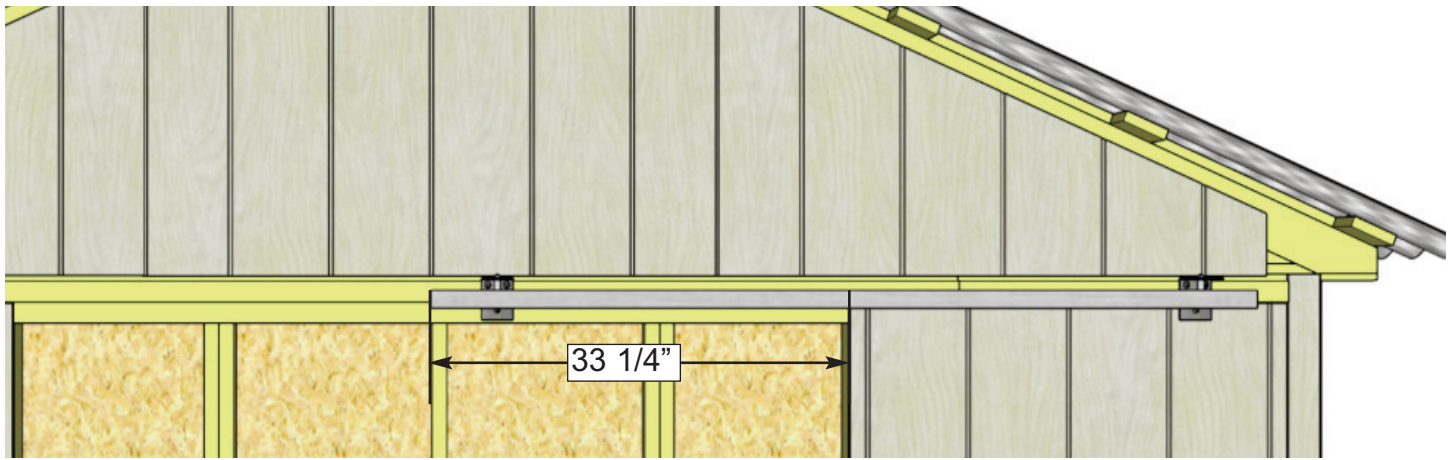

Bottom of bracket flush with bottom of interior Door Header.

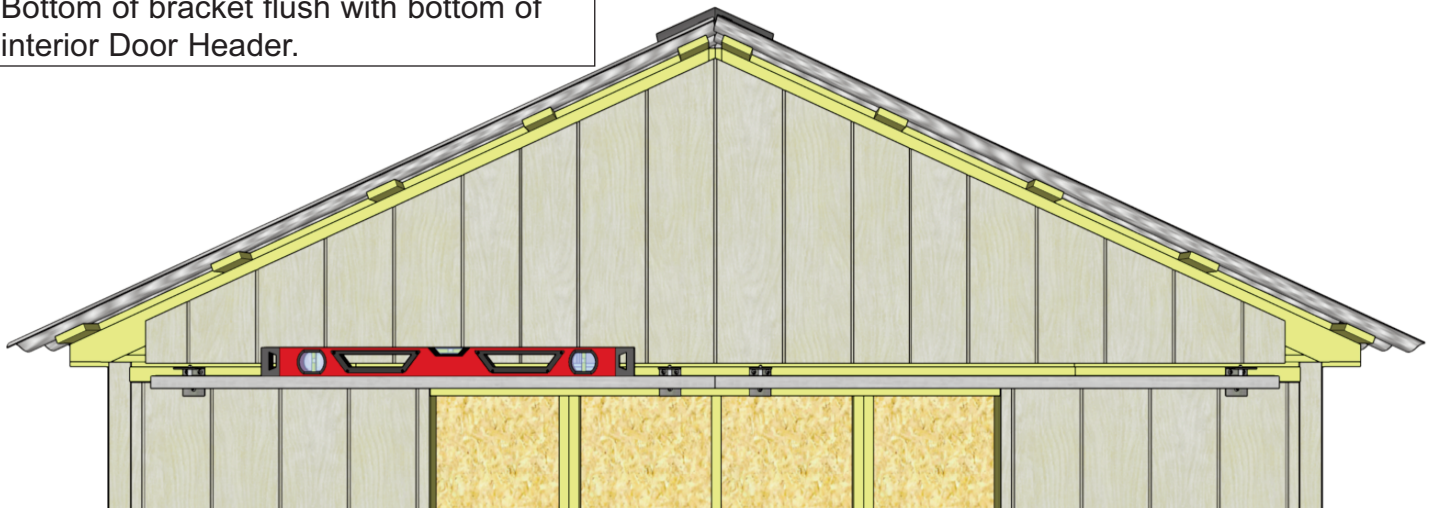

48. Position **Aluminum Door Tracks** so they meet in the center of the doorway and with the pre-installed brackets fitting evenly on Door Headers. Ensure Track is level and attach with **1 - 1 1/2" Torx Screw** per bracket to hold in place while aligning other Track. Position second Track the same and attach with **3 - 1 1/2" Torx Screws** per bracket. Complete remaining Torx Screws on brackets of first Track.

<u>Parts</u> Aluminum Door Track x 2	<u>Hardware</u> ST1 - 1 1/2" Torx Screws x 12 total
--	---

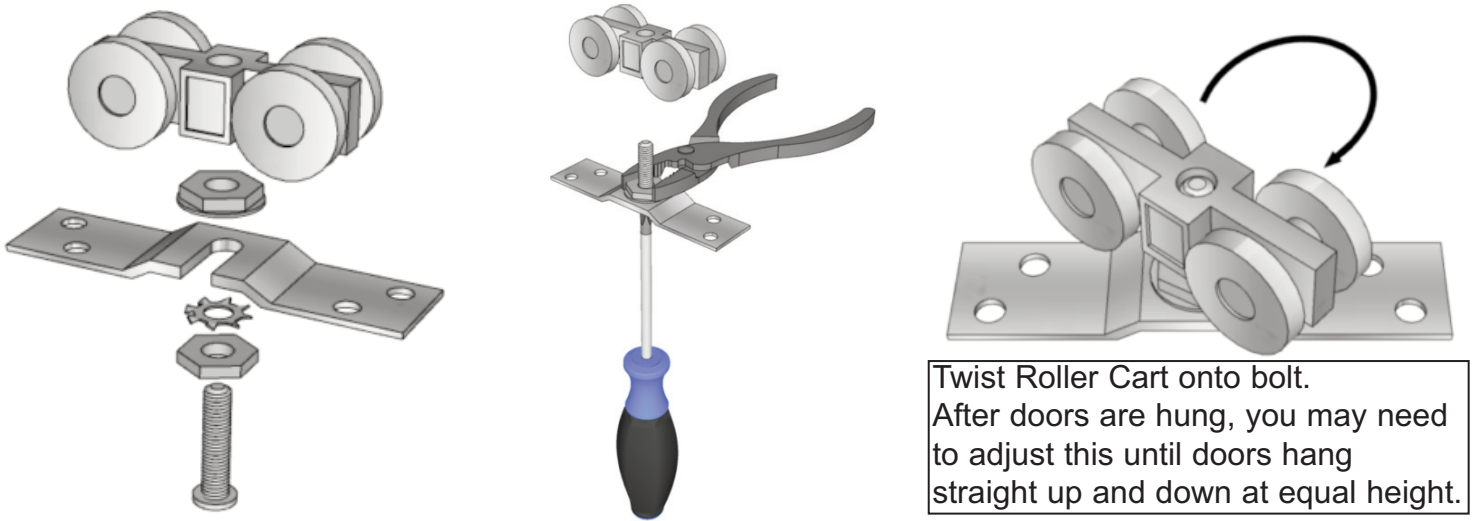

Twist Roller Cart onto bolt.
After doors are hung, you may need to adjust this until doors hang straight up and down at equal height.

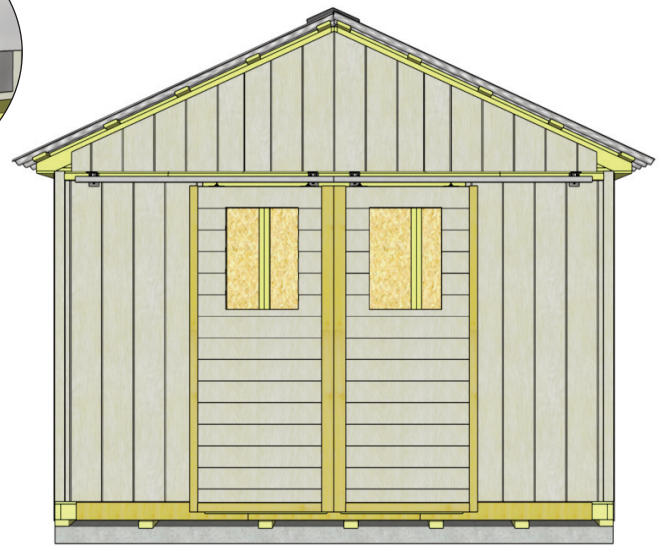
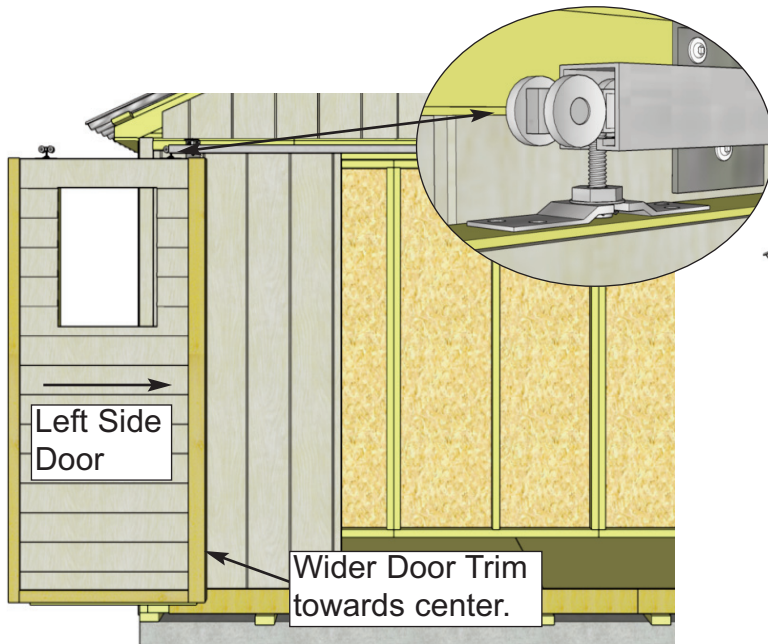

49. Locate all four **Y35 - Roller Assemblies**. Before attaching to top of doors, assemble the units as shown above. Attach two Roller Assemblies to each door with **4 - 1 1/4" Screws** per Assembly, center on the door framing **4"** from each end as shown above. Next, take Left Side Door and slide Rollers into the Aluminum Door Track. Repeat with Right Side Door and slide until doors meet in the middle.

<u>Parts</u> Sliding Doors (36" x 73") x 2
<u>Hardware</u> S2 - 1 1/4" Screws x 16 total Y35 - Roller Assembly x 4 total

Note: If there is a gap between your doors at the top or bottom, remove the door and twist the Roller Assemblies to adjust the height until they hang parallel.

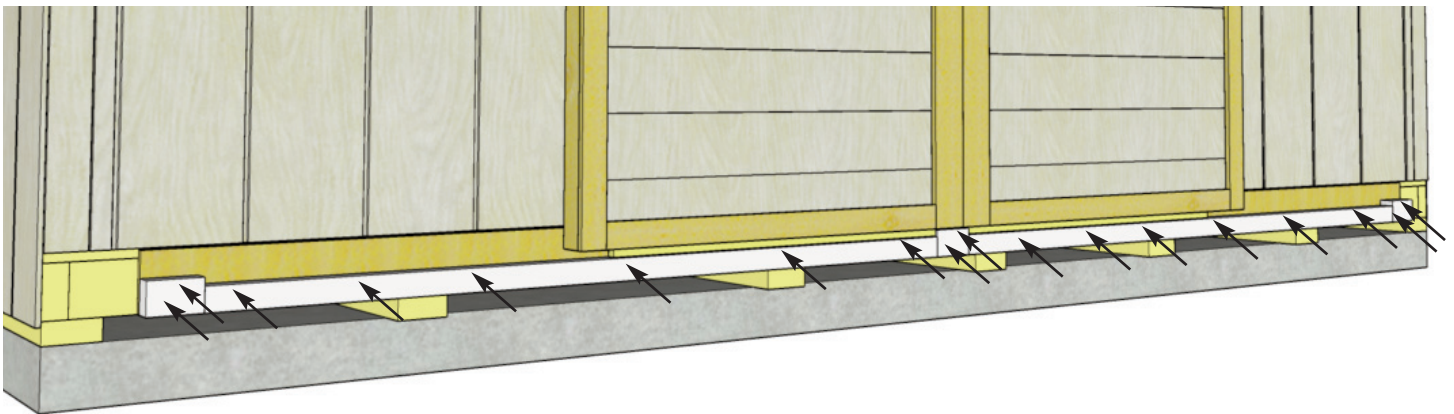
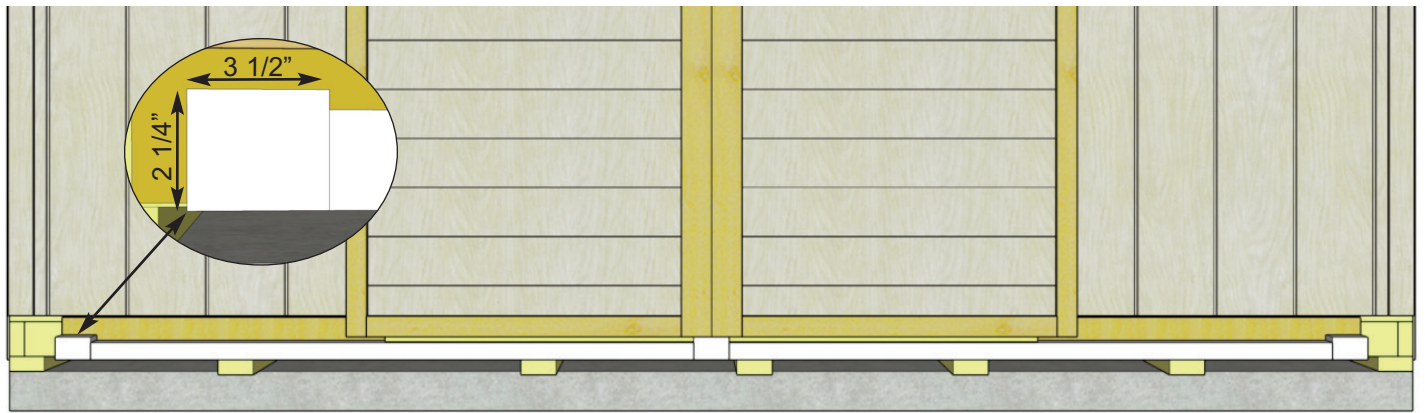
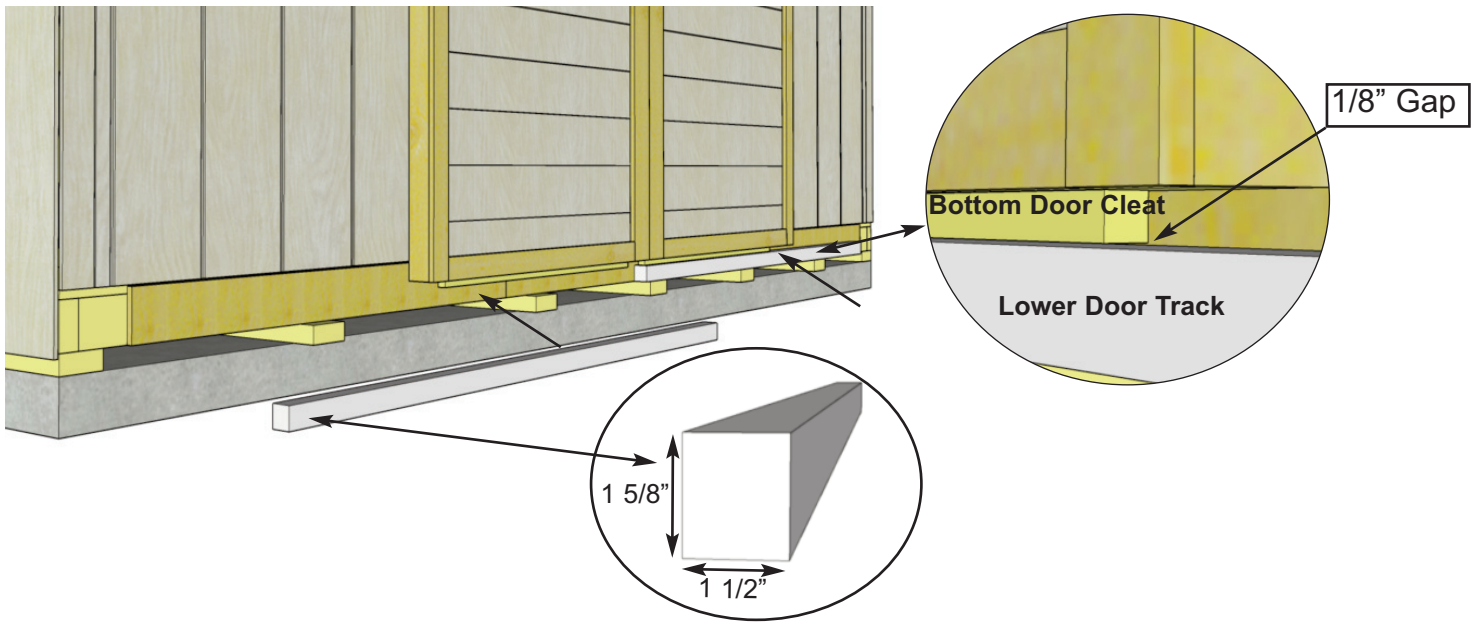

50. Locate **Door Tracks** and **Door Stops**. Middle Door Stop should be centered on shed and outer Door Stops should be 1 1/2" from edge of bottom skirting. Door Tracks rest on Long Floor Runners. Bottom of Door Stops and Door Tracks should be flush with each other. Secure Door Tracks to shed with **6 - 3" screws** per piece. Secure Door Stops with **2 - 3" screws** per piece.

<u>Parts</u>
Lower Door Track (1 1/2" x 1 5/8" x 60") x 2
Door Track Stops (1 1/2" x 2 1/4" x 3 1/2") x 3
<u>Hardware</u>
S4 - 3" Screws x 18 total

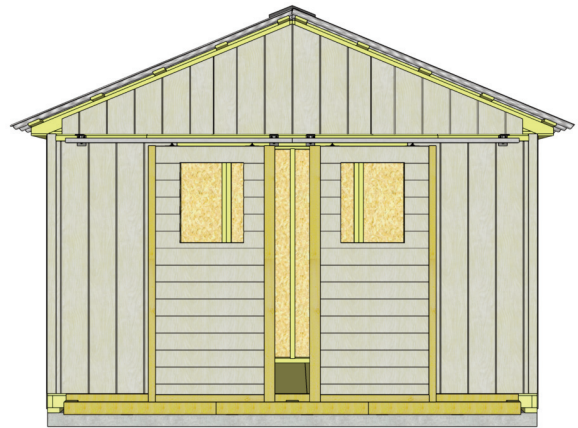
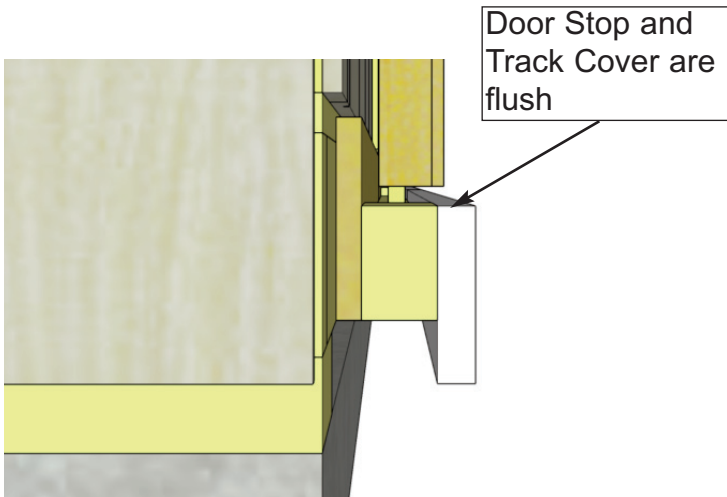
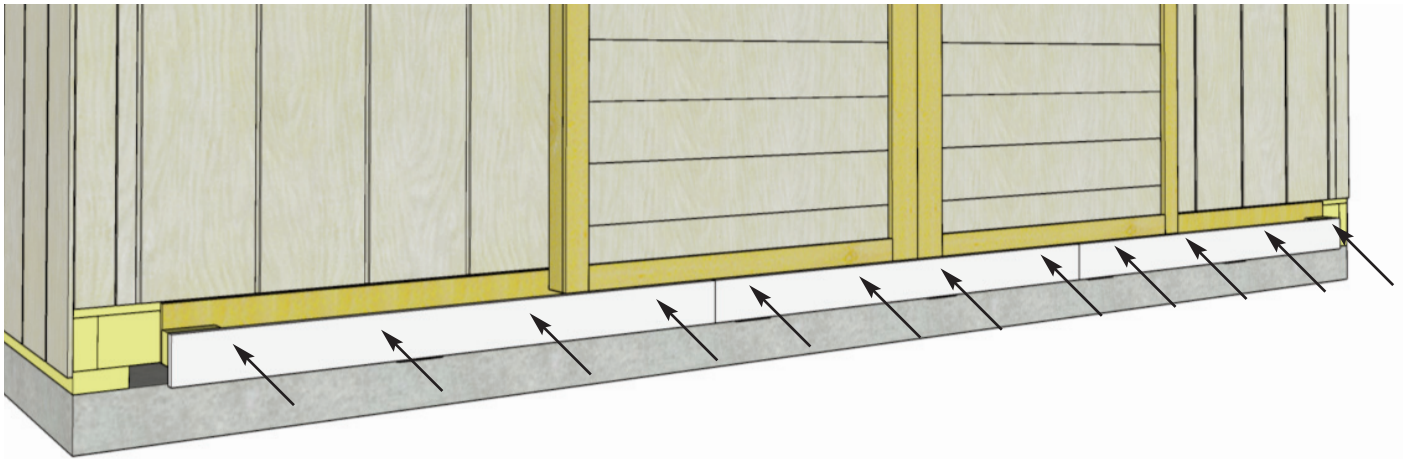
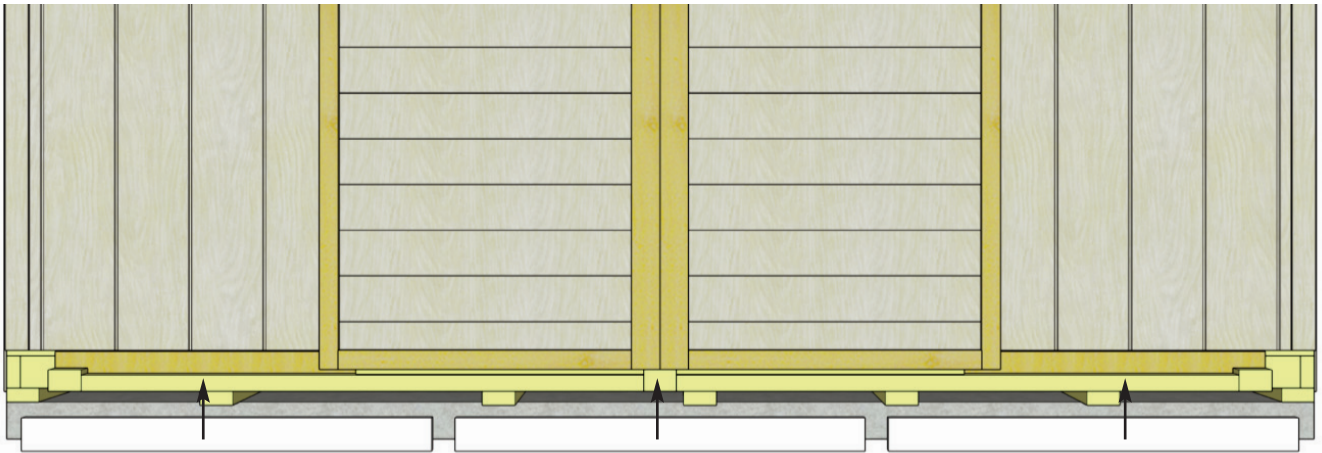

51. Locate **Door Track Covers**. Lineup so Track Covers are flush with Door Stops. This creates an enclosure so doors can not slide out of the track. Secure each piece of Track Cover with **4 - 2 1/2" screws**.

Parts
Lower Door Track Cover
 (3/4" x 3 1/2" x 43 1/2") x 3

Hardware
S1 - 2 1/2" Screws
 x 12 total

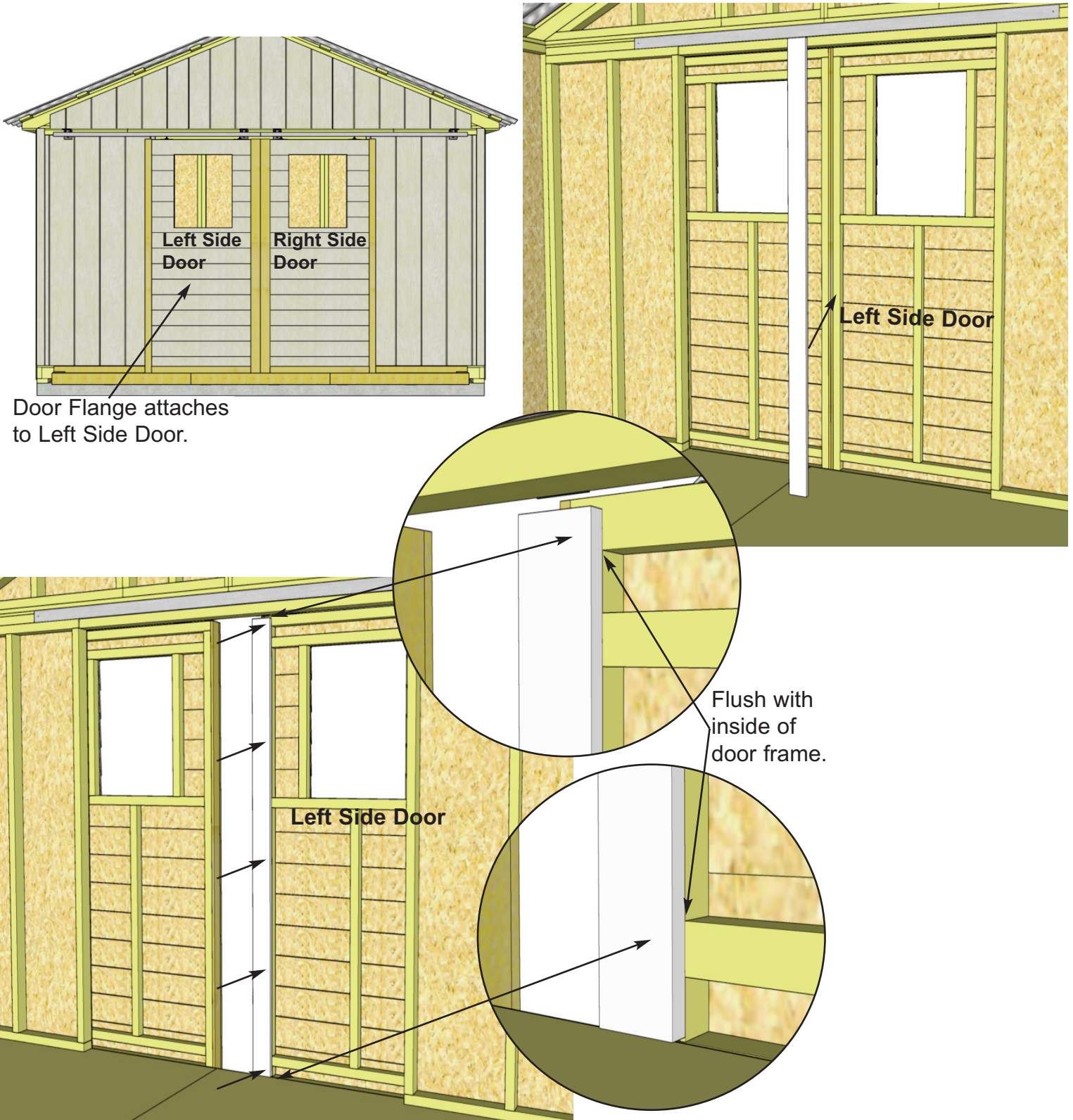

52. Position **Interior Door Flange** on the rear of the left side door (when viewed from the front of the shed). Ensure flange is flush with the inside of the door frame and attach with **5 - 1 1/4" Screws**.

<p><u>Parts</u> Interior Door Flange (3/4" x 3 1/2" x 71 1/2") x 1</p>
<p><u>Hardware</u> S2 - 1 1/4" Screws x 5 total</p>

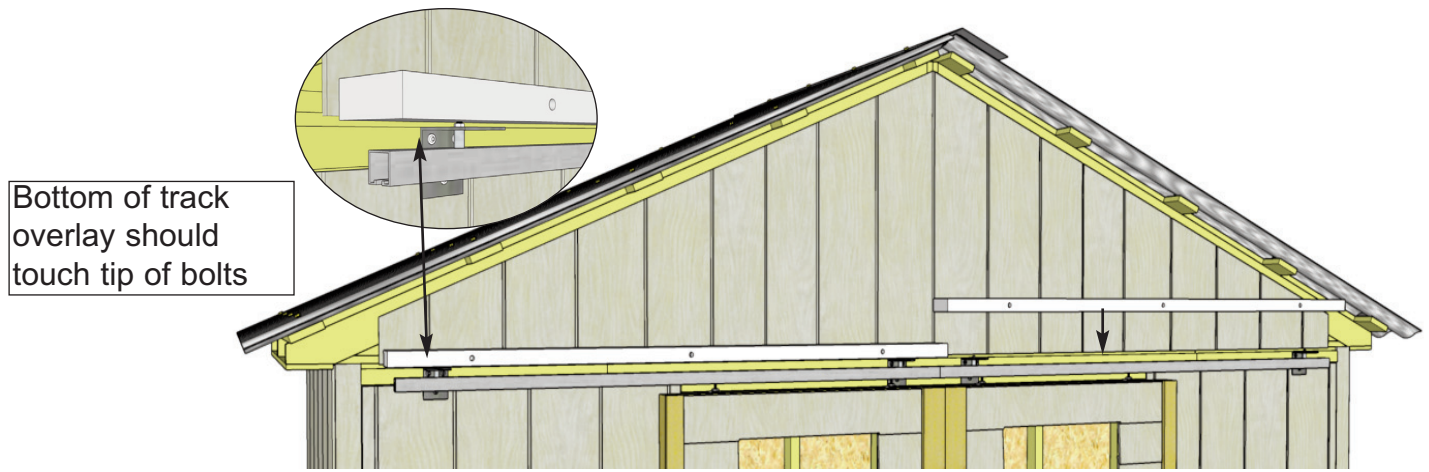

53. Install both **Track Overlay Top** pieces above the aluminum tracks. Position pieces horizontally as shown above. Attach with **3 - 4" Screws** per piece through the pre-drilled holes.

<u>Parts</u> Track Overlay Top (1 1/2" x 3 1/2" x 66") x 2	<u>Hardware</u> S5 - 4" Screws x 6 total
---	---

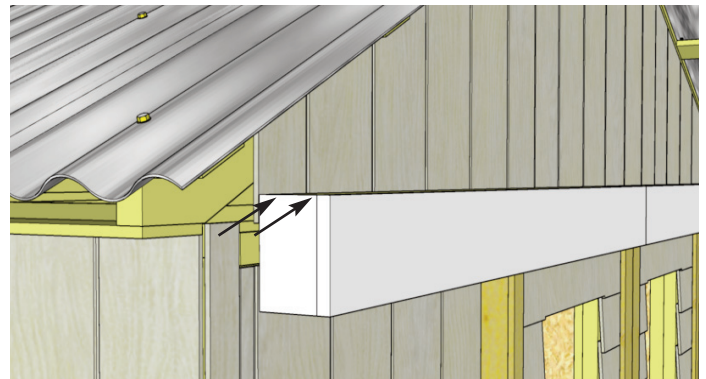
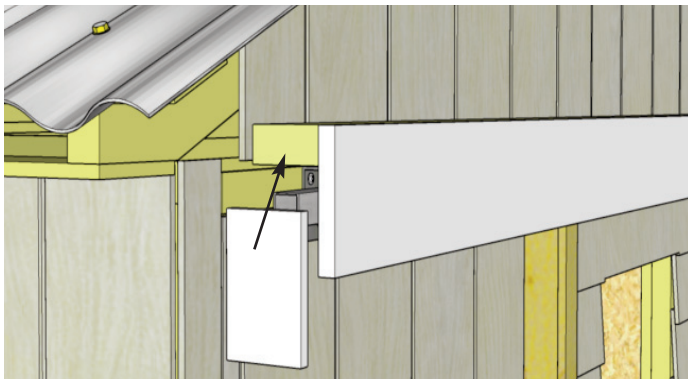
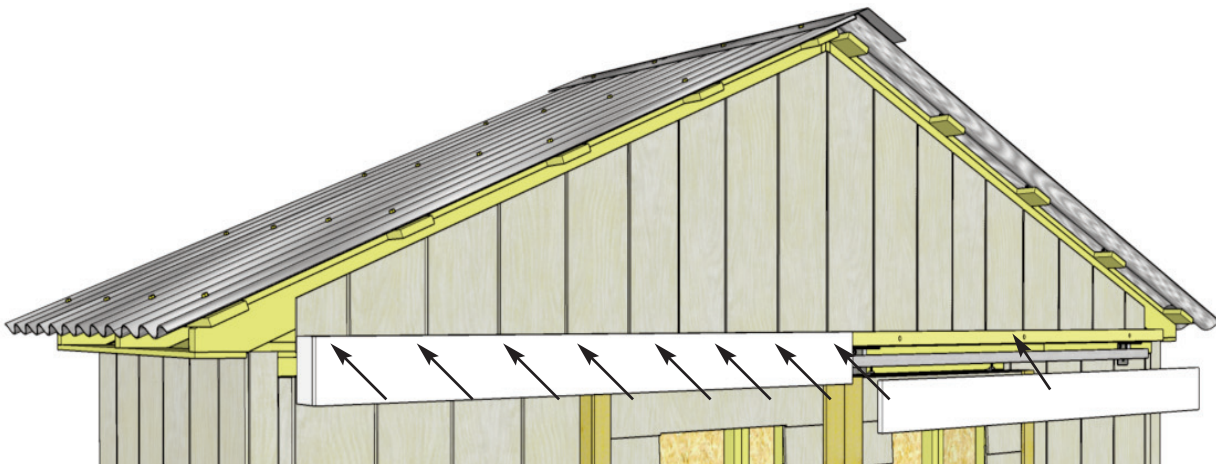

54. Position both of **Track Overlay - Front** onto the edge of the **Overlay Top** so they meet at the center. Ends of the Overlay Front will protrude 1/2" past the ends of the Overlay Top. Attach with **8 - 1 1/2" Finishing Nails** per piece. Next, attach **Track Overlay - Ends** as shown above with **4 - 1 1/2" Finishing Nails** per piece.

<u>Parts</u> Track Overlay Front (3/4" x 5 1/2" x 66 1/2") x 2 Track Overlay Ends (1/2" x 3 1/2" x 5 1/2") x 2	<u>Hardware</u> N1 - 1 1/2" Finishing Nails x 24 total
--	---

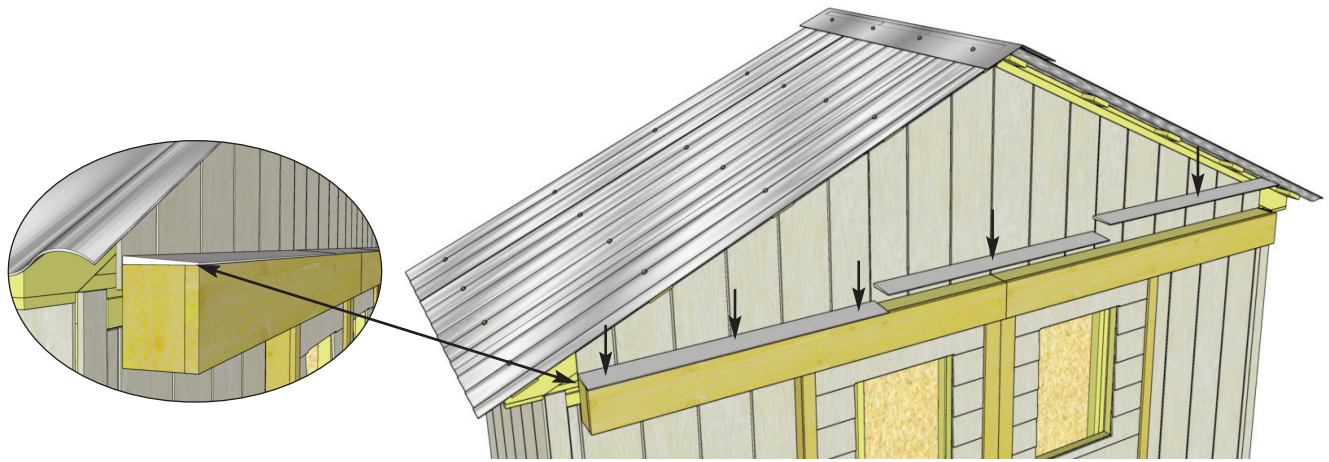

55. Position **Track Overlay - Sill** pieces evenly on top of **Track Overlay** with the slope facing away from the shed. This will prevent rainwater from collecting on top. Attach with **3 - 1 1/2" Finishing Nails** per piece. Hammer carefully and support the Track Overlay from below if necessary to avoid knocking it loose.

<u>Parts</u> Track Overlay Sill (1/2" x 4 1/4" x 44 1/4") x 3	<u>Hardware</u> N1 - 1 1/2" Finishing Nails x 9 total
--	--

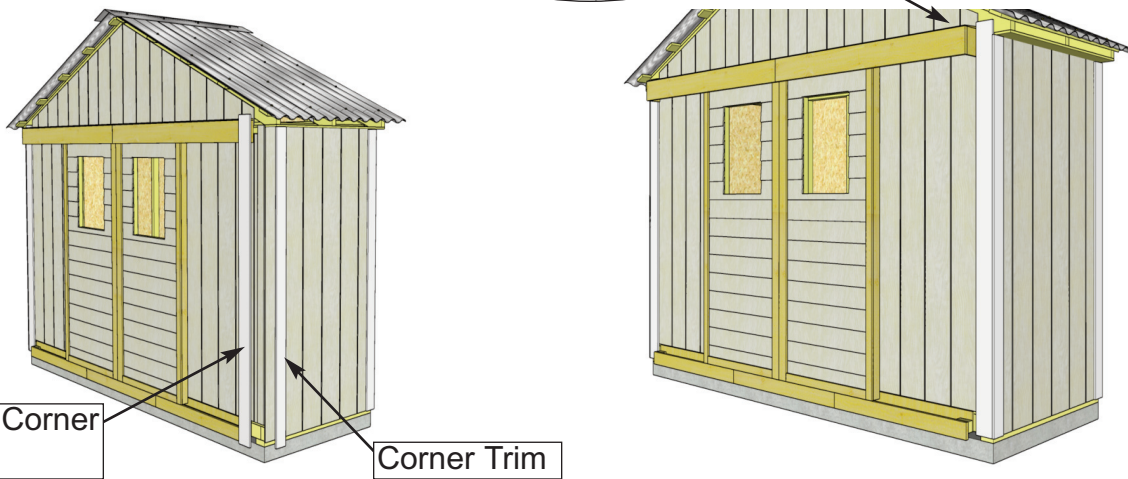
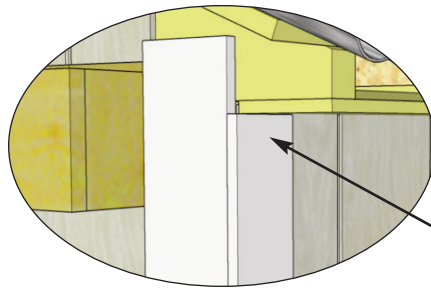

56. To trim out corners, start with a **Corner Trim**, align tight underneath Soffit and Rafter. Align **Wide Corner Trim** with bottom of Corner Trim. Corner Trim will cap the Wide Corner Trim. Do a dry run in each corner before attaching to confirm positioning. Use **8 - 1 1/2" Finishing Nails** per piece to secure. Complete each corner the same way.

<u>Parts</u> Wide Corner Trims (1/2" x 4 1/2" x 82") x 4 Corner Trims (1/2" x 3 1/2" x 79") x 4	<u>Hardware</u> N1 - 1 1/2" Finishing Nails x 64 total
---	---

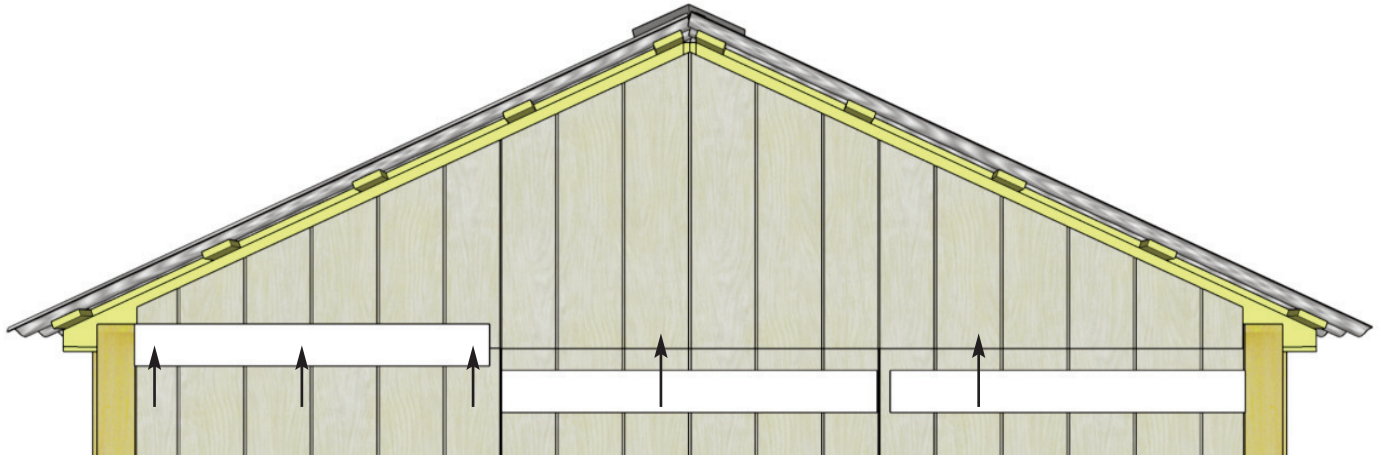
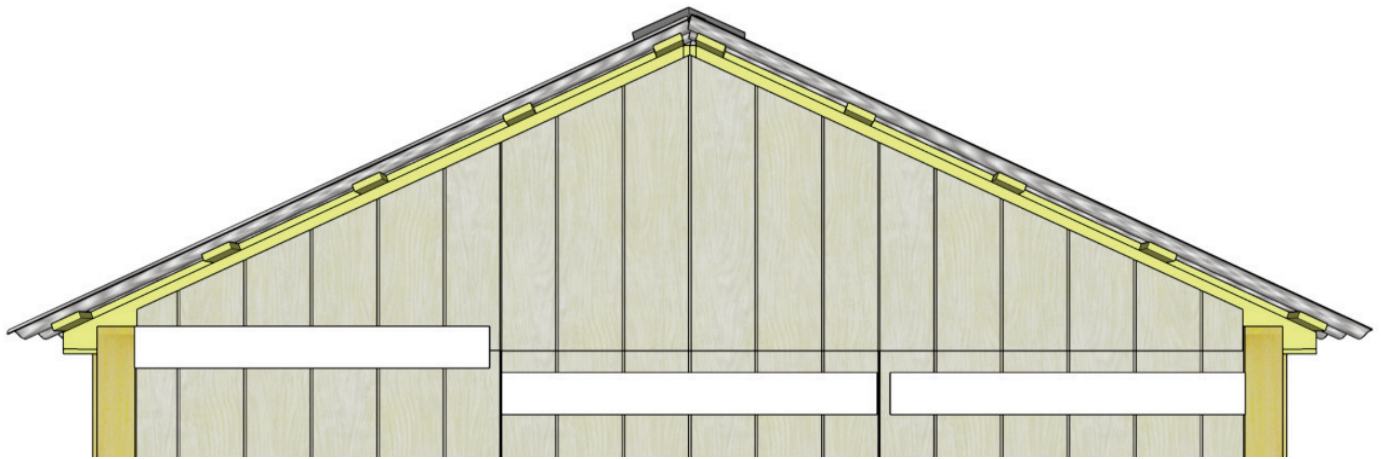

57. Attach **Horizontal Gable Trims** to rear of shed. Position over gable and wall seam between wide corner trims. Use **4 - 1 1/2" Finishing Nails** to secure each piece. Gap between trims will be covered by a Detail Plate later in **Step 63**. Do a dry run with Rear Wall Trims from **Step 58**.

Parts	Hardware
Horizontal Gable Trims (1/2" x 4 1/2" x 44 1/4") x 3	N1 - 1 1/2" Finishing Nails x 12 total

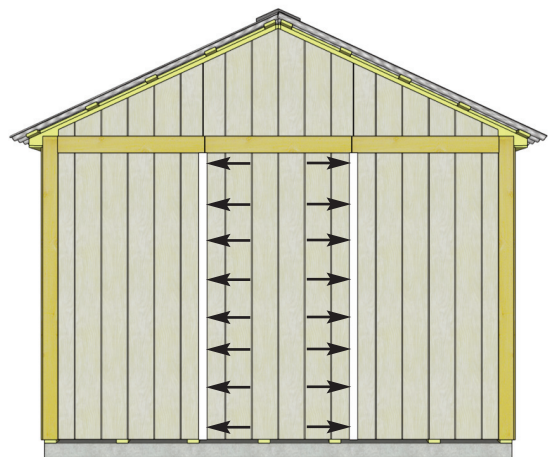
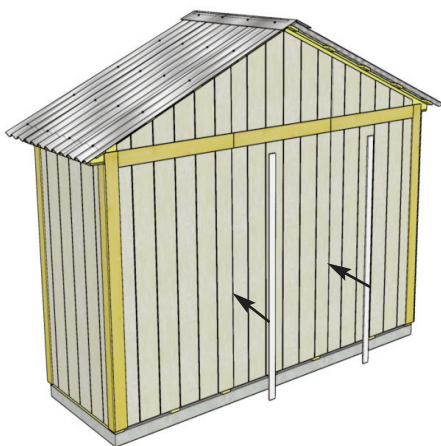

58. Locate **Rear Wall Trims** and position over seams in rear walls panels, tight under Horizontal Gable trims. Attach with **8 - 1 1/2" Finishing Nails** per piece.

Parts	Hardware
Rear Wall Trims (1/2" x 2 1/2" x 77 1/2") x 4	N1 - 4 1/2" Finishing Nails x 16 total

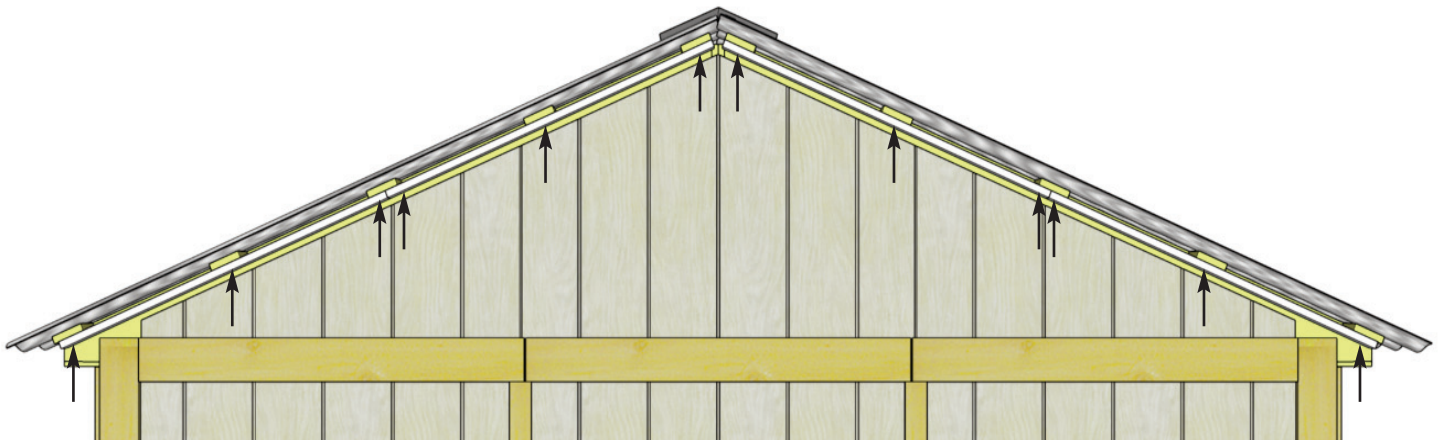
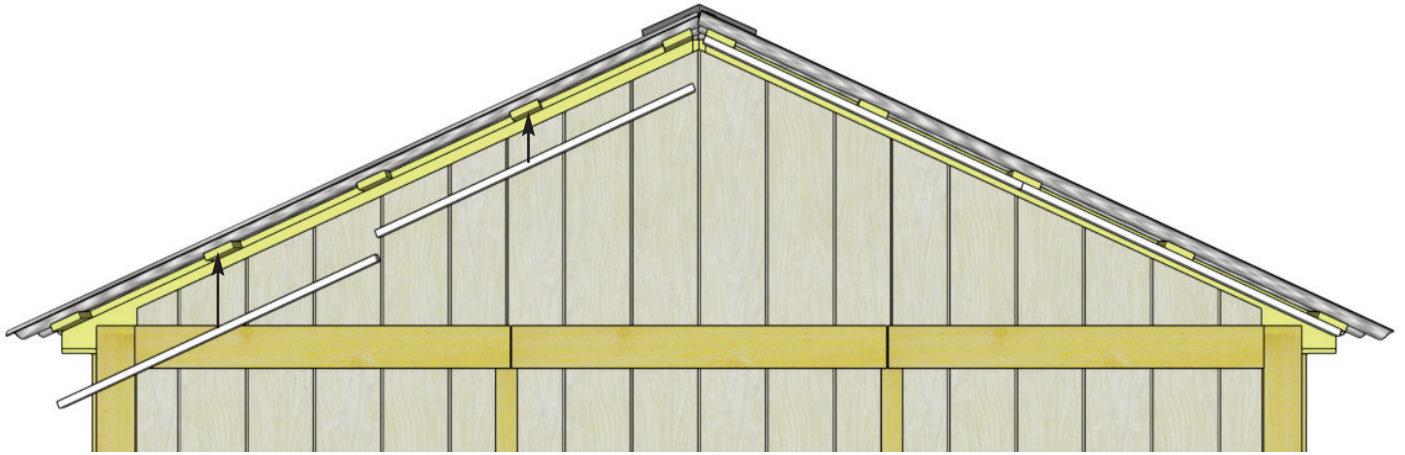

59. Attach **Facia Nailing Strips** to the underside edge of roof battens with **3 - 1 1/4" Screws** per piece. Nailing Strip will make it easier to attach Angle Cut Facia in **Step 60**. Complete attaching strips both the front and rear of shed.

<p><u>Parts</u> Facia Nailing Strips (3/4" x 1 1/2" x 40") x 8</p>	<p><u>Hardware</u> S2 - 1 1/4" Screws x 24 total</p>
---	---

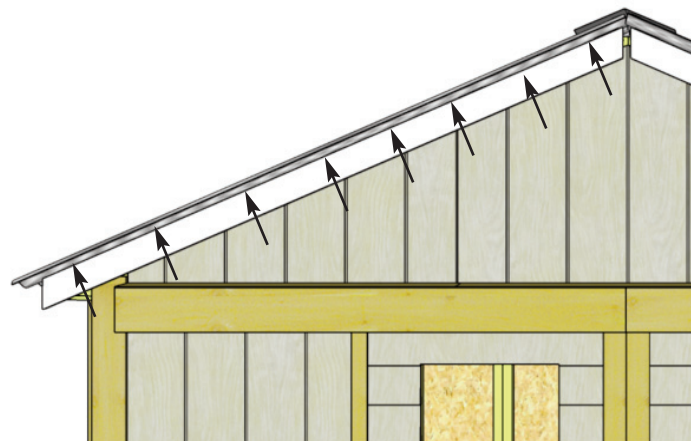
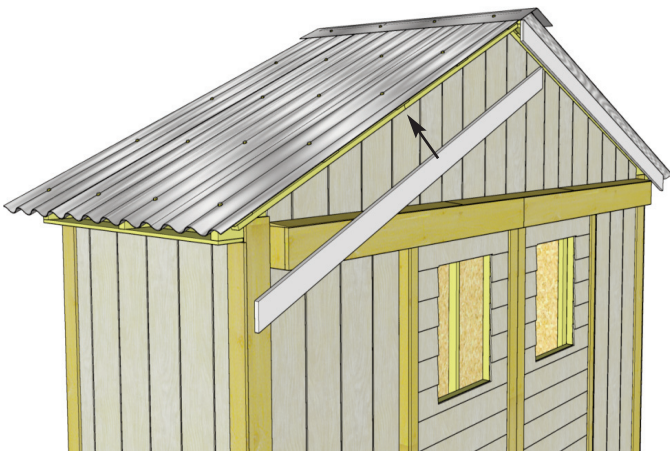

60. Attach **Angle Cut Facia** to nailing strips (2 pieces per side). Secure with **8 - 1 1/2" Finishing Nails** per piece, end of Facia should be aligned 3/4" past end of Rafter. Gap where Facia boards come together at peak will be covered in **Step 62**. Do a dry run with **Side Facia** from **Step 61**

<p><u>Parts</u> Angle Cut Facia L/R (3/4" x 3 1/2" x 81 1/4") x 4</p>	<p><u>Hardware</u> N1 - 1 1/2" Finishing Nails x 32 total</p>
--	--

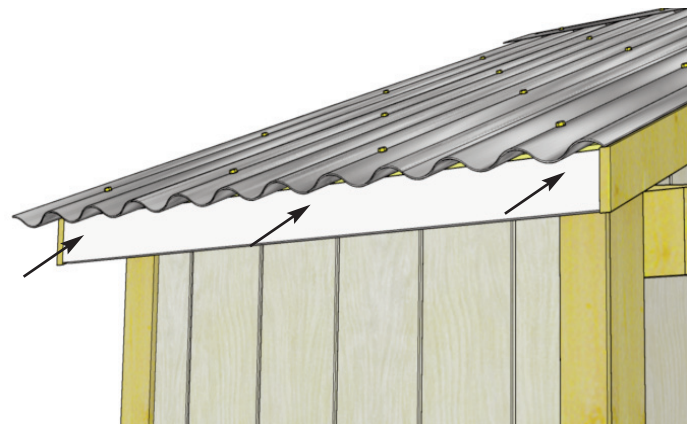
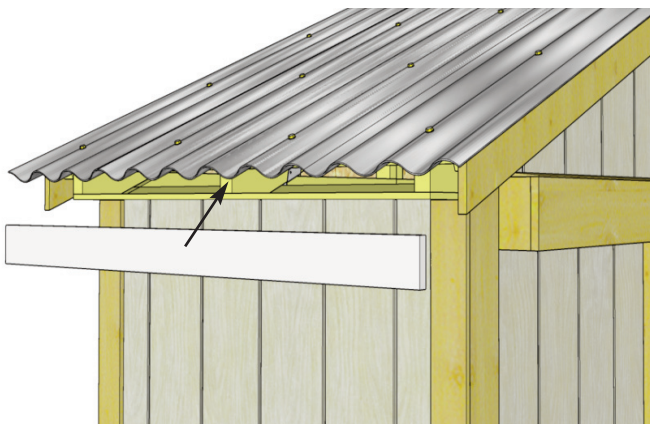

61. Attach **Side Facia** to Rafter Ends. Secure with **3 - 1 1/2" Finishing Nails** per piece, end of Facia should be capped by Angle Cut Facia. Complete both sides of shed.

<u>Parts</u> Side Facia (3/4" x 3 1/2" x 51 3/4") x 2	<u>Hardware</u> N1 - 1 1/2" Finishing Nails x 6 total
--	--

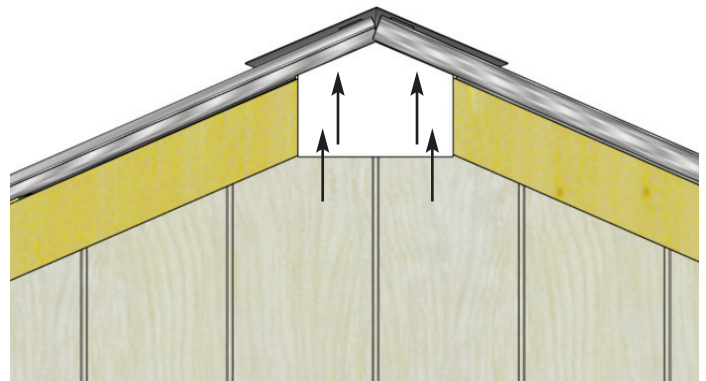
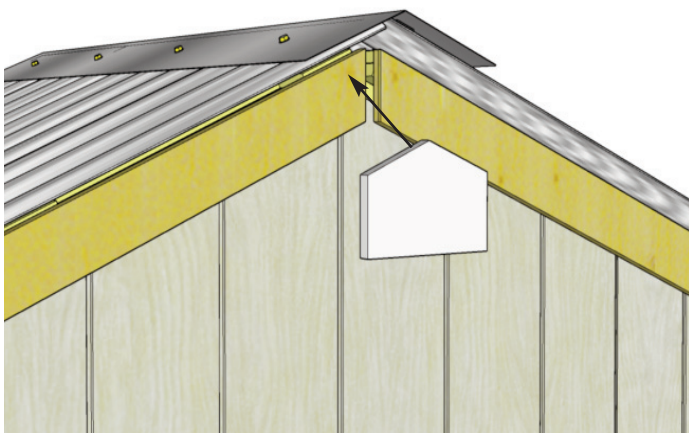

62. Attach **Pentagon Detail Plate** where Angled Facia meets at the peak. Use **4 - 1 1/2" Finishing Nails** per piece to secure.

<u>Parts</u> Pentagon Detail Plate x 2	<u>Hardware</u> N1 - 1 1/2" Finishing Nails x 8 total
---	--

Front

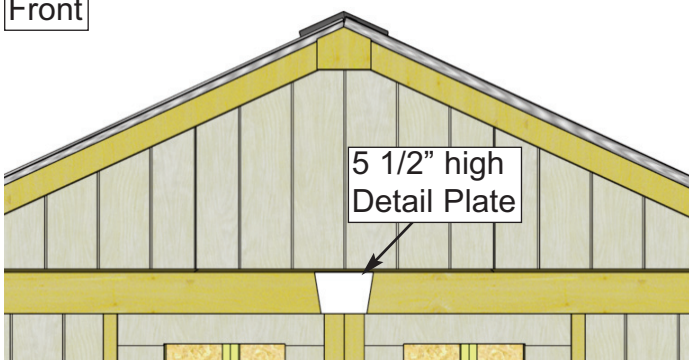

Rear

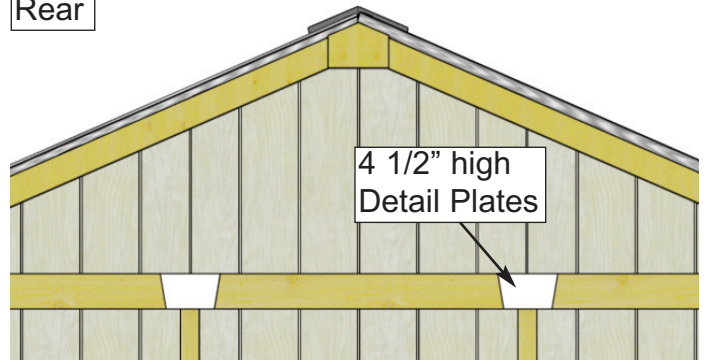

63. Locate remaining **Trim Detail Plates**. Attach **5 1/2" high Detail Plate** over seam in Front Track Overlay. Attach two **4 1/2" high Detail Plates** over seams in Horizontal Gable Trims on rear wall. Use **4 - 1 1/2" Finishing Nails** per piece to secure.

<u>Parts</u> Trim Detail Plates (5 1/2" high) x 1 (4 1/2" high) x 2
<u>Hardware</u> N1 - 1 1/2" Finishing Nails x 12 total

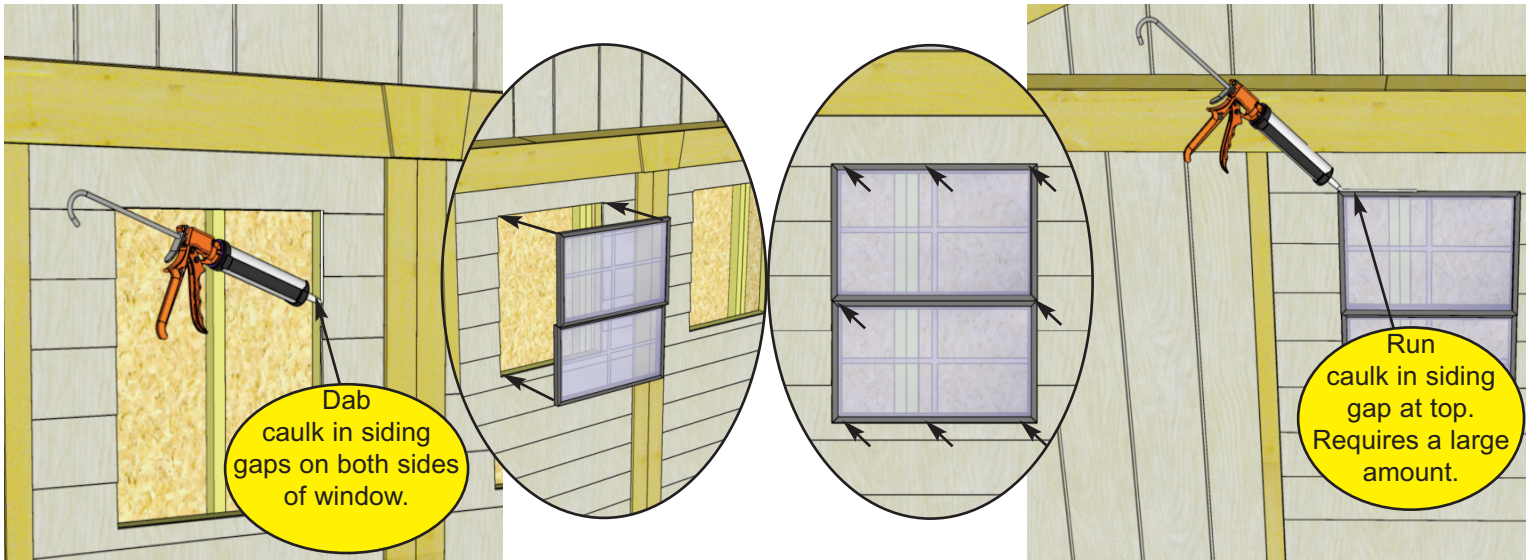

64. Locate Window Inserts. Before installing, dab caulk in siding channel on both sides of window opening. This will prevent water from getting in behind window. Position window in cavity and secure with **8 - 1 1/4" Screws**. Caulk gap between siding and window at top. This requires a large amount of caulking but is important to fill. Later, Window Trims will be installed to hide caulking. Complete second Window Insert the same.

<p><u>Parts</u> Window Inserts (18 1/4" x 23") x 2</p>
<p><u>Hardware</u> S2 - 1 1/4" Screws x 16 total</p>

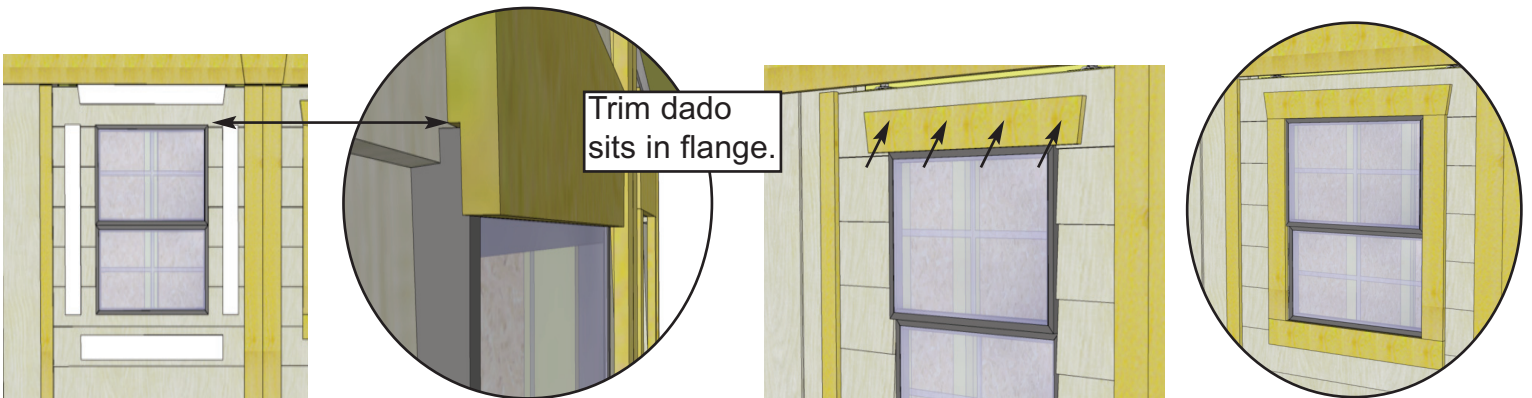

65. Position Window Trim around window doing a dry run first and attach with **4 - 1 1/2" Finishing Nails** per piece. Window trim has a small dado on reverse face. Outside flange of window will roughly sit in the dado to give a better fit. Complete both windows the same.

<p><u>Parts</u> Window Trim Kit x 2 (Top pc - 24 1/16") x 1- Angle Ends (Side/Bottom pcs - 23") x 3</p>
<p><u>Hardware</u> N1 - 1 1/2" Finishing Nails x 32 total</p>

66. Attach Door Handles and Black Hasp. Handles and Hasp are positioned on wide door trim and mounted with **3/4" Black Screws**.

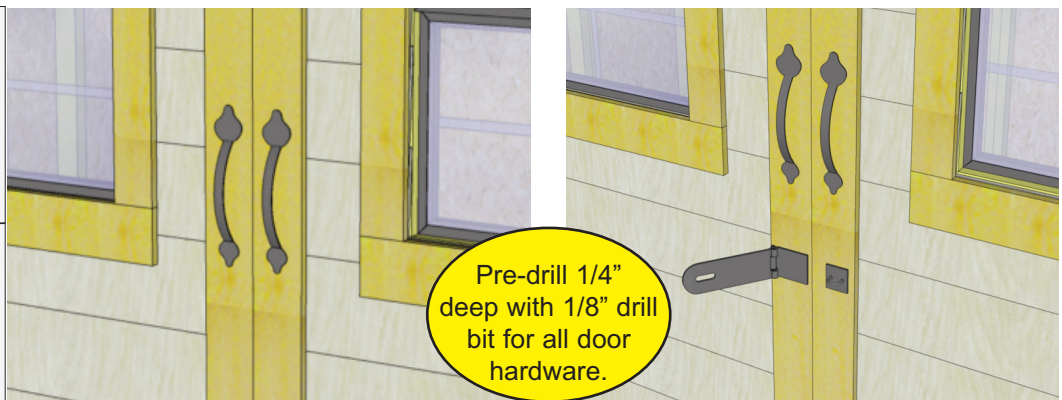

<p><u>Hardware</u> Door Handles x 2 total Black Hasp x 1 total SB1 - 3/4" Screws x 16 total</p>



Congratulations on assembling your 12x4 XXXXXXX Shed with Sliding Doors & Metal Roof!

Note: Our Sheds are shipped as unfinished products. If exposed to the elements, the western red cedar lumber will weather to a silvery-gray color. If you prefer to keep the cedar lumber looking closer to the original color, we suggest that you treat the wood with a good oil base wood stain. You may also wish to paint your new shed rather than stain it. In both cases we recommend that you consult with a paint and stain dealer in your area for their recommendations.

We hope your experience assembling your 12x4 Slider Lean-To Storage Shed has been both positive and rewarding.

We value your feedback and would like to hear back from you on how well we are doing in the following areas:

1. Customer Service
2. On Time Shipping
3. Motor Freight Delivery
4. Quality of Materials
5. Assembly Manual
6. Overall Satisfaction.

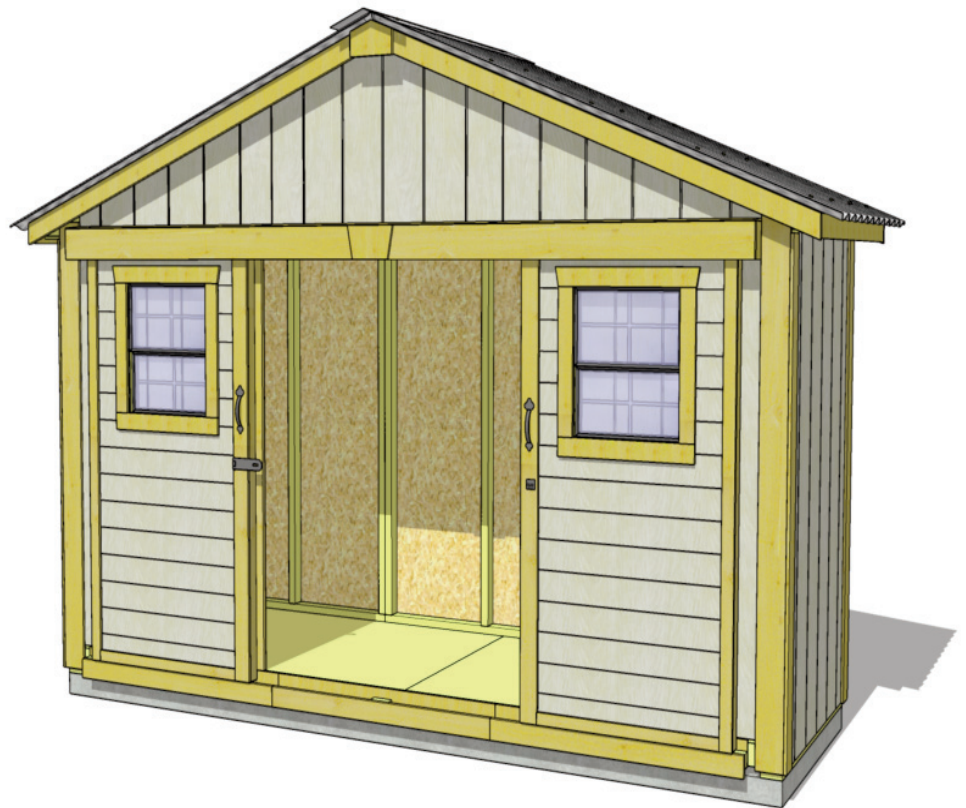

Please call, write or email us at:

Outdoor Living Today

Canadian Address
9393 287th Street
Maple Ridge, British Columbia
Canada V2W 1L1

United States Address
P.O. Box 96
Sumas, Washington
USA 98295



The materials contained in this Assembly Manual may be downloaded or copied provided that ALL copies retain the copyright and any other proprietary notices contained on the materials. No material may be modified, edited or taken out of context such that its use creates a false or misleading statement or impression as to the positions, statements or actions.