



12x12 Space Maker Garden Shed with Plywood Roof & AK Siding Assembly Manual

Revision #1.4
Mar 8, 2022

Thank you for purchasing a 12x12 SpaceMaker Garden Shed from Outdoor Living Today. Please take the time to identify all the parts prior to assembly.



Safety Points and Other Considerations
Our products are built for use based on proper installation and normal residential use, on level ground. Please follow the instruction manual when building your shed and retain the manual for future maintenance purposes.

Roof Area: 160 sqft

Important Information:

- It is the sole responsibility of the customer to check with your local municipal or county by-laws before ordering this product to confirm it complies with building codes in your area.
- If the product is elevated, any structural and building code requirements are solely the customer's responsibility, and should be abided by.
- Customer agrees to hold Outdoor Living Today free of any liability for improper installation, maintenance and repair of any of our products.
- Snow load ratings vary by geographical location. If heavy or wet snowfall occurs, it is advisable to sweep the snow off the roof(s).
- In high or gusty wind conditions it is advisable to keep the structure securely grounded.
- Have a regular maintenance plan to ensure screws, doors, windows and parts are tight.
- In the event of a missing or broken piece, call the Outdoor Living Today Customer Support Line @ 1-888-658-1658 within 30 days of the delivery of your purchase. It is our commitment to you to courier replacement parts, free of charge, within 10 business days of this notification. Replacement parts will not be provided free of charge after the 30 day grace period.
- All structures purchased from Outdoor Living Today are covered for a period of one year for defects in manufacturing and workmanship. Costs incurred for customer installations are not included.
- Failure to use supplied parts included in this kit could result in poor product performance and may void your warranty. Please contact Outdoor Living Today's Customer Toll Free Line if you plan to deviate from our written instructions.

What to do before my Shed arrives?



- Become familiar with this assembly manual and determine if you can complete the project yourself or will require a professional contractor.



- One helper is recommended to assist in constructing your shed. It generally takes two people 3 to 4 days to assemble a shed. If you're hiring a contractor, their rate should be in line with that duration of work.



- Clear the construction area and ensure a clear pathway for delivery when the freight company arrives. Remove all debris: roots, grass, rocks, etc.



- Excavate the site. Contact your local utilities company to ensure there are no gas or electric lines buried in the area before digging.



- Decide on the type of foundation you will be using:
 - Concrete slab, or
 - 4-6 inches of crushed gravel with paver stones or 4x4 stringers.

You can find the footprint for your shed on Page 3 of your Assembly Manual.



- If doing the assembly yourself, have all the necessary tools ready to go and in working condition. A list of required tools can be found after the parts list.

Foundation Types for 12x12 Garden Shed

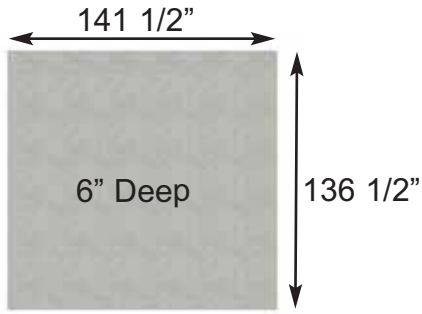

Front Side
Concrete Foundation

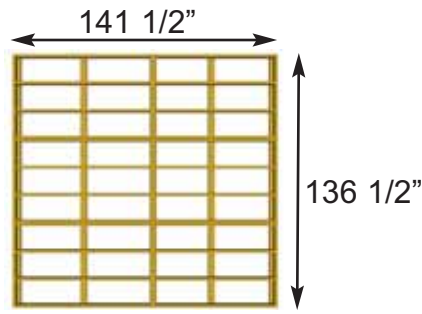

Front Side
Floor Frame

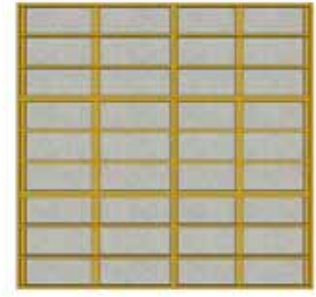

Front Side
Completed Foundation

Concrete Slab Foundation:

- Slab must be at least the same size as assembled floor frame (141 1/2" x 136 1/2") or larger.
- 6" Deep foundation.
- 2.5 Cubic Yards of concrete required.
- A concrete slab will have the longest durability out of your foundation options.

Once level, a concrete slab is the easiest surface to build on.

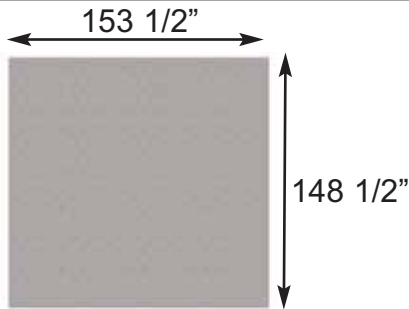

Front Side
Gravel Foundation

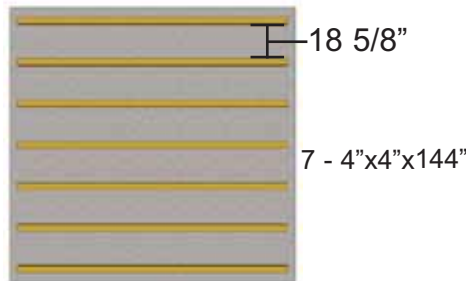

Front Side
Gravel Foundation with treated stringers

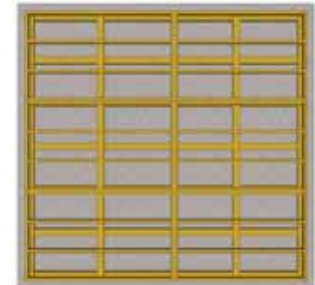

Front Side
Completed Foundation

Gravel with 4x4 Pressure Treated Stringers:

- Excavate at least 6" deep, and 6" wider than floor frame on each side.
- 3.0 Cubic Yards of gravel required, approximately 27 wheelbarrows.
- 7 - 4x4 Pressure Treated Stringers 12' long required.
- Evenly spaced, with one at each end of floor frame.

Saves money on materials, easy to level and work with.

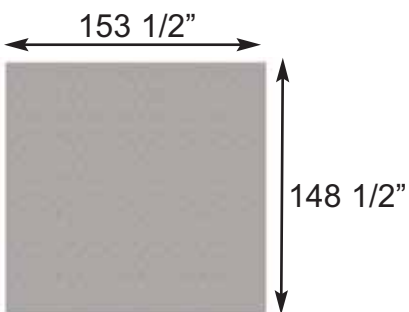

Front Side
Gravel Foundation



35 Patio Stones
Front Side
Gravel Foundation with Patio Pavers

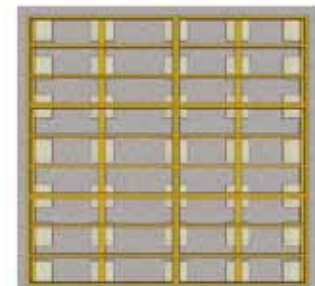

Front Side
Completed Foundation

Gravel with Patio Paver Stones:

- Excavate at least 6" deep, and 6" wider than floor frame on each side.
- 3.0 Cubic Yards of gravel required, approximately 27 wheelbarrows.
- 35 patio pavers (8" x 8" or larger).
- Center patio paver stones underneath floor runners and underneath seams in floor joists.

Patio paver stones are widely available from most landscape stores.

**Thank you for purchasing our 12x12 SpaceMaker Garden Shed.
Please take the time to identify all the parts prior to assembly.**

1. Floor Section	Parts List - Page 4-5	Steps ↓
Floors -----		
3 - 45 1/2" x 75" - Floor Joist Frames - Large 3 - 45 1/2" x 66 1/2" - Floor Joist Frames - Small 6 - 1 1/2" x 3 1/2" x 72" - Floor Joists Large - Unattached 6 - 1 1/2" x 3 1/2" x 63 1/2" - Floor Joists Small - Unattached 5 - 1 1/2" x 3 1/2" x 76 1/2" - Floor Runners 5 - 1 1/2" x 3 1/2" x 60" - Floor Runners 3 - 5/8" x 45 1/2" x 75" - Floor Plywood Large 3 - 5/8" x 45 1/2" x 66 1/2" - Floor Plywood Small		1 - 8
2. Wall Section		Steps ↓
Main Wall Panels -----		
8 - 45 1/2" x 81 3/4" - Solid Wall Panels 1 - 45 1/2" x 81 3/4" - Solid Wall Panel With Extra Vertical Studs 9 - 1 1/2" x 2 1/2" x 45 1/2" - Bottom Wall Plates 2 - 34 3/4" x 81 3/4" - Narrow Window Wall Panels		9 - 16
Door Headers -----		
2 - 1 1/2" x 3 1/2" x 73" - Vertical Door Jambs 1 - 1 1/2" x 2 1/2" x 70" - Door Header Riser 1 - 1 1/2" x 7 1/4" x 70" - Door Header 2 - 1/2" x 7 1/4" x 70" - Door Header Spacer 1 - 67" long - Drip Edge with Bevel Siding attached		17 - 22
Top Wall Plates & Gables -----		
4 - 1 1/2" x 2 1/2" x 70 3/4" - Front & Rear Riser Plates 4 - 1 1/2" x 2 1/2" x 65 3/4" - Side Riser Plates 4 - 3/4" x 2 1/2" x 45" - Front & Rear Top Plates (angle cut ends) 2 - 3/4" x 2 1/2" x 51 1/2" - Front & Rear Top Plates (straight cut ends) 4 - 3/4" x 2 1/2" x 35 3/4" - Side Top Plates (angle cut edge) 2 - 3/4" x 2 1/2" x 60" - Side Top Plates (angle cut edge) 4 - Triangular Gable Walls (end tip tucked inside)		23 - 28
3. Rafter and Roof Section		Steps ↓
Rafter Assembly -----		
2 - 3/4" x 9 1/4" x 68 1/4" - Roof Ridge Boards 3 - 3/4" x 9 1/4" x 45 1/2" - Roof Ridge Boards 18 - 1 1/2" x 3 1/2" x 80 7/8" - Roof Rafters (angle cut ends) 4 - 1/2" x 4 1/2" x 68 1/4" - Soffits 3 - 3/4" x 80" x 19 3/4" - Triangular Roof Gussets		29 - 42
Roof -----		
4 - 5/8" x 48" x 81 1/2" - Roof Plywood 2 - 5/8" x 45 1/2" x 81 1/2" - Roof Plywood		43 - 46

Continued on next page

4. Trim & Miscellaneous Section	Steps ↓
Outer Wall Trim & Door 1 - 1/2" x 1 1/2" x 67" - Above Doorway Trim 9 - 3/4" x 4 1/2" x 45 1/4" - Bottom Skirting (Bevel) - Solid Wall 2 - 3/4" x 4 1/2" x 33 3/4" - Bottom Skirting (Bevel) - Window Wall 1 - 3/4" x 4 1/2" x 68 1/2" - Bottom Skirting (Bevel) - Door 4 - 7/8" x 2 1/2" x 81 3/4" - Filler Trims 6 - 3/4" x 1 1/2" x 45 1/4" - Top Wall Trims 3 - 3/4" x 4 1/2" x 45 1/4" - Horizontal Gable Trims (Rear) - Bevel 1 - 3/4" x 4 1/2" x 68 1/2" - Horizontal Gable Trims (Door) - Bevel 2 - 3/4" x 4 1/2" x 32 1/4" - Horizontal Gable Trims (Window) - Bevel 8 - 1/2" x 2 1/2" x 87" - Side Trims 4 - 1/2" x 5 1/2" x 90" - Wide Corner Trims 2 - 1/2" x 2 1/2" x 85" - Rear Wall Trims 2 - 1/2" x 3 1/2" x 85" - Vertical Door Trims	47 - 56
Facia Trim 8 - 3/4" x 1 1/2" x 40" - Facia Cleat 4 - 3/4" x 5 1/2" x 81 1/4" - Front and Rear Facia Angled 4 - 3/4" x 5 1/2" x 71 1/4" - Side Facia 2 - 9 1/2" x 7 3/8" - Pentagon Detail Plates 2 - 8" x 5 1/2" Facia Detail Plates 4 - 8" x 4 1/2" Front & Rear Detail Plates	57- 62
Miscellaneous 2 - 31 1/2" x 72" - Left & Right Doors (1 each) 2 - 1/2" x 2 1/2" x 72" - Interior Vertical Door Stops 1 - 1/2" x 2 1/2" x 68" - Interior Horizontal Door Stop 1 - 3/4" x 2 1/2" x 62 1/2" - Door Threshold 1 - 1/2" x 2 1/2" x 71" - Interior Door Flange 2 - Regular Window Inserts 2 - Regular Window Trim Pkgs 2 - Flower Box Kits 2 - Spare Bevel Siding 1 - Spare Lap Siding 2 - Spare Shingles - use to shim door, etc	63 - 73

Advice: Wood has a tendency to split when screwing near the ends of a board. To prevent splitting, it is always recommended to pre-drill pilot holes before screwing into these areas.



Note: Trim Pieces are to be installed with the rough side facing out. Rough side is graded as best face.

12x12 SPACEMAKER WITH PLY ROOF HARDWARE SHEET

Hardware Kit (Provided)

2 1/2"  400 pcs

2"  245 pcs

2"  39 pcs
Black Headed

3/4"  24 pcs
Silver

3/4"  23 pcs
Black Headed

1 1/4"  505 pcs

1 1/2"  650 pcs
Finishing

 2 pcs
Square Drive Bit



Y6 - Cane Bolt



Black Drop Latch



Double Rafter Bracket x 4 (22°)



Single Rafter Bracket x 6 (22°)



Tee Hinge x6



Pull Handle x 2



Ridge Board Connector x 3

Tools Required (Not Provided)



Hammer



Screw Gun/Drill



Tape Measure



Wood Clamp



Caulking Gun



Level



Pliers



Ladder



1/8" Drill Bits

Safety Equipment Required (Not Provided)



Safety Glasses



Work Gloves

Before/During Assembly:

- 1.) Paint each face and edge of your plywood floor with a latex exterior paint.
- 2.) Caulk wall seams if gaps appear.
- 3.) Caulk around window framing.
- 4.) Caulk perimeter between floor plywood and bottom wall plate.
- 5.) Caulk channels in lap siding at the top of your door above the trim, just a drop in each channel.
- 6.) Caulk edge of door threshold (if applicable).
- 7.) Optional: Install a Sill Gasket between floor runners and foundation.
- 8.) Optional: Install an 8" strip of roofing paper below Cedar Ridge Caps for Cedar Roof Sheds.

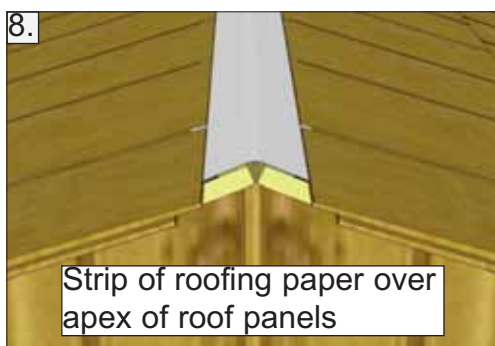
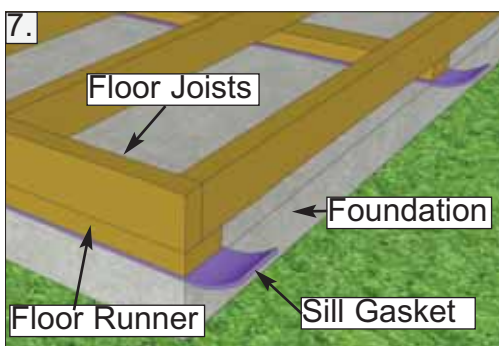
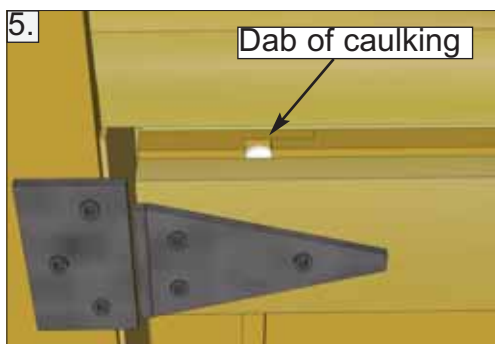
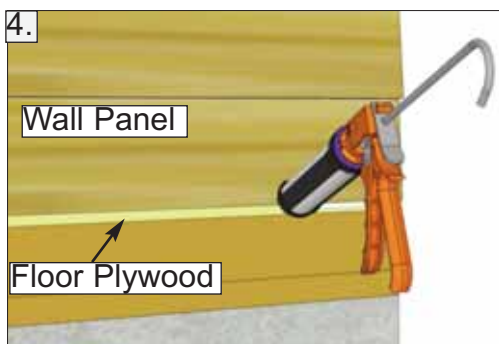
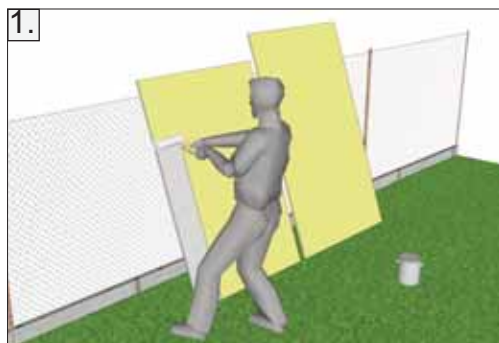

Routine Maintenance:

- Routinely check all fasteners are tight (ex. Door Hinges, Nails)
- Brush off dirt from walls.
- Brush off snow from roof regularly.
- Routinely remove needles and leaves from roof.

Painting/Staining

- Your cedar shed, if left untreated, will weather to a silvery grey color.
- Painting or staining your structure is highly recommended and will prolong the life of your shed.
- You do not need to wait to paint or stain your shed, the wood in your kit has been dried and can be stained or painted immediately.
- Consult your local paint store for the best paint or stain for cedar.
- Optional: stain the inside of your shed. (Note: this will remove the fresh cedar smell.)

A. Floor Section

Exploded view of all parts necessary to complete Floor Section. Identify all parts prior to starting. Note, Floor Footprint is 136 1/2" deep x 141 1/2" wide.

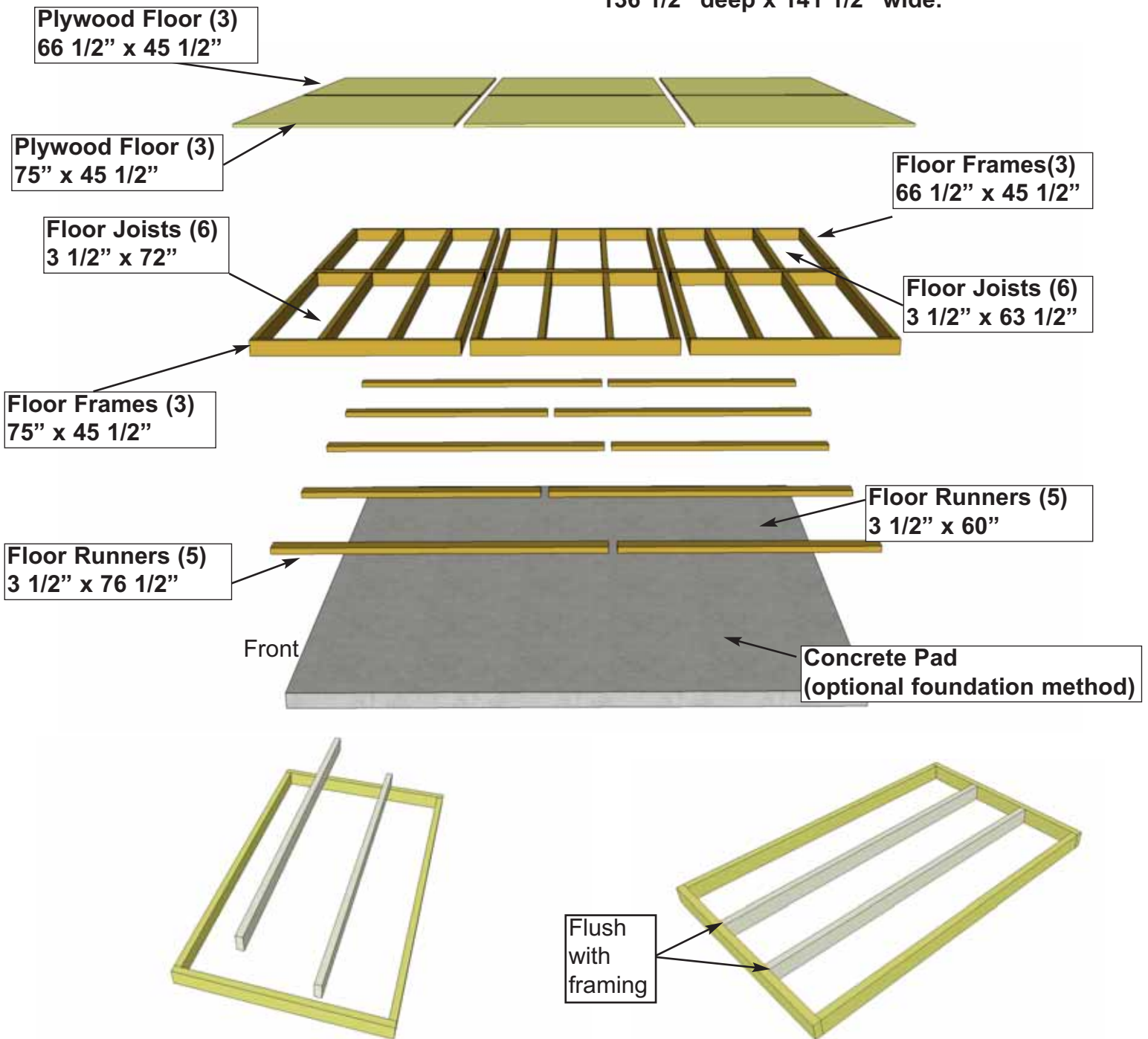

1. Lay out all **Floor Joist Frames and Floor Joists** on ground as illustrated above. Position 72" Floor Joists in 75" frames and 63 1/2" Floor Joists in 66 1/2" frames. Position Joists equally in Floor Joist Frame. Position Joist so flush with framing.

Parts (Steps 1 - 3)
Floor Joists - Large
 (1 1/2" x 3 1/2" x 72") x 6
Floor Joists - Small
 (1 1/2" x 3 1/2" x 63 1/2") x 6
Floor Joist Frames - Large
 (45 1/2" x 75") x 3
Floor Joist Frames - Small
 (45 1/2" x 66 1/2") x 3

Hardware (Steps 1 - 3)
S1 - 2 1/2" Screws
 x 66 total

You can find the Square Drive Bit for the screws in with the Hardware Kit Bag.

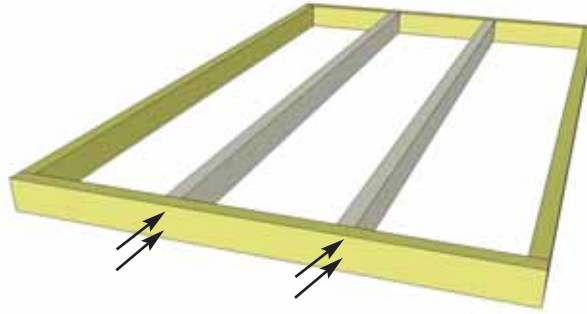

2. When correctly positioned, attach each Joist with **4 - 2 1/2"** screws (2 per end). Complete all Floor Frame and Joist connections. **You can find the Square Drive Bit for the screws in with the Hardware Kit Bag.**

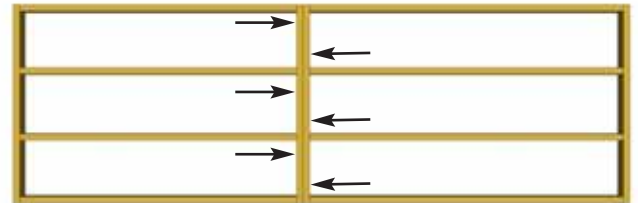
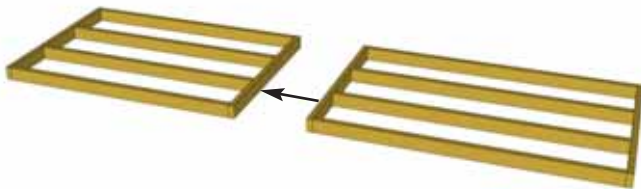

3. Lay out **one of each Floor Frames** as shown above. Attach th **66 1/2"** frame to the **75"** with **6 - 2 1/2"** screws (18 total). Complete 3 sets.

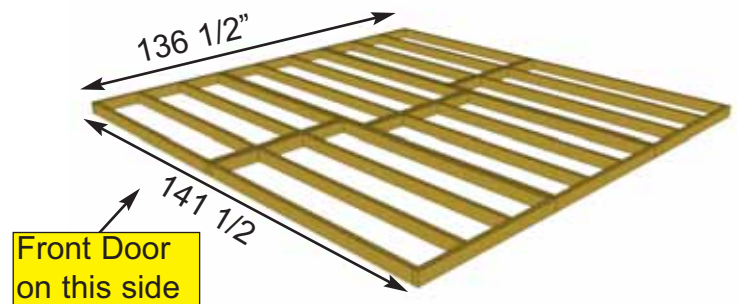
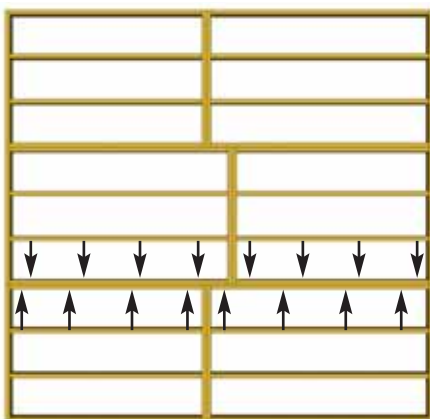

4. Attach each completed section together with **16 - 2 1/2"** screws as illustrated above.

Hardware (Step 4)
S1 - 2 1/2" Screws
 x 32 total

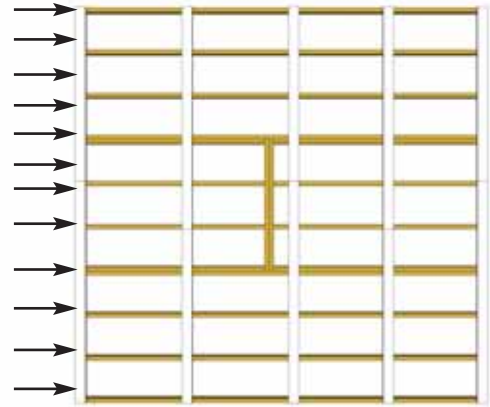
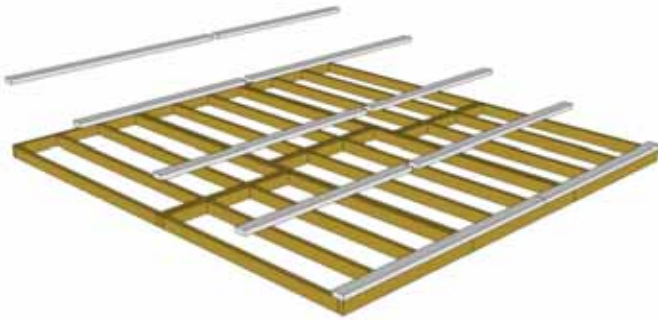

5. Attach **Floor Runners** to completed floor frame. There are 2 floor runner pieces per 136 1/2" side and 5 completed runners in total. use **6 - 2 1/2" screws** per runner.

Parts (Step 5)
Floor Runners - Long
 (1 1/2" x 3 1/2" x 76 1/2") x 5
Floor Plywood - Short
 (1 1/2" x 3 1/2" x 60") x 5

Hardware (Step 5)
S1 - 2 1/2" Screws
 x 32 total

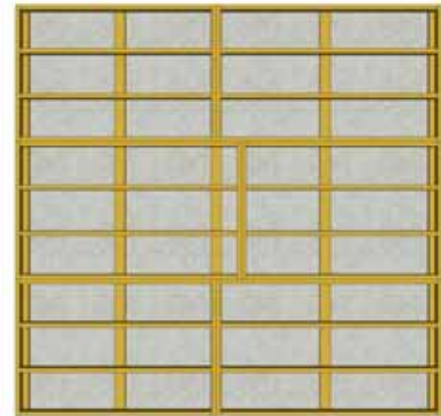

6. With some helpers, flip the floor section over so it rests on your foundation. **Caution:** you will need 2 people to assist you. Be careful when laying floor down not to bend or twist floor. When in place, level floor completely.

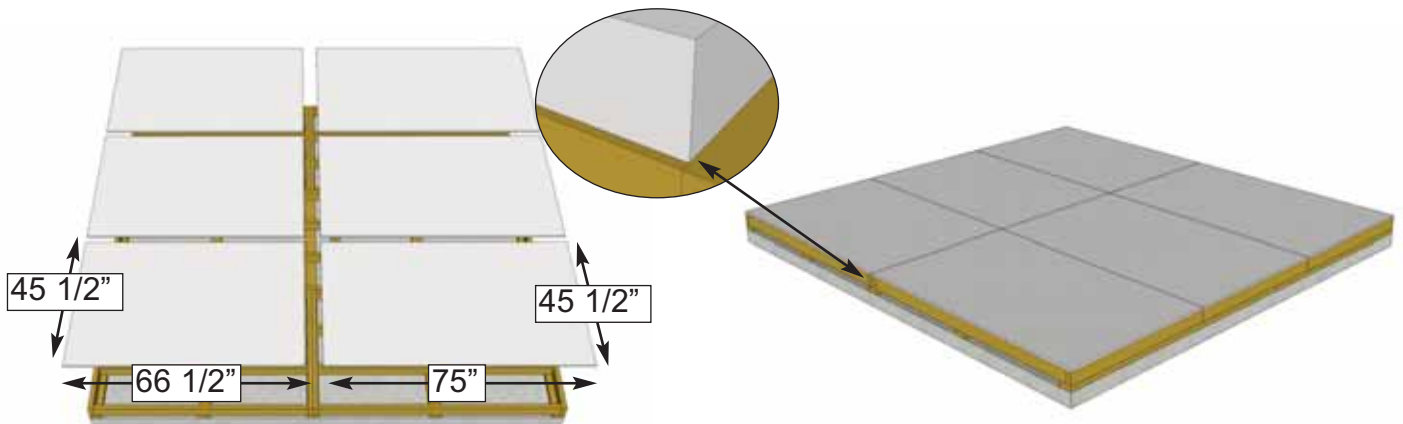

7. Position **Plywood Floor** pieces (6) on top of completed **Floor Joists**. Plywood will sit slightly back from edge of **Floor Joist Framing**.

Parts (Steps 7 - 8)
Floor Plywood - Large
 (5/8" x 45 1/2" x 75") x 3
Floor Plywood - Small
 (5/8" x 45 1/2" x 66 1/2") x 3

Hardware (Steps 7 - 8)
S2 - 1 1/4" Screws
 x 120 total

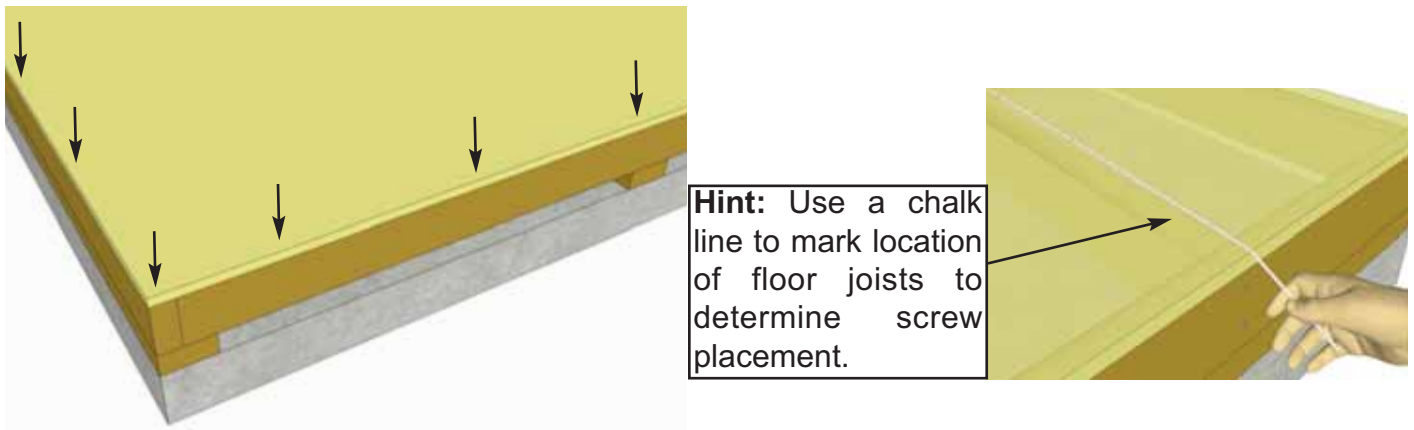

8. With **Floor Plywood** pieces in position, attach **with 1 1/4" screws**. Use screws every 16" (approximately 90 total). The plywood is cut slightly smaller than floor framing. Keep plywood seams tight.

Important: Check to confirm that your floor is level prior to proceeding to the next step of wall assembly.

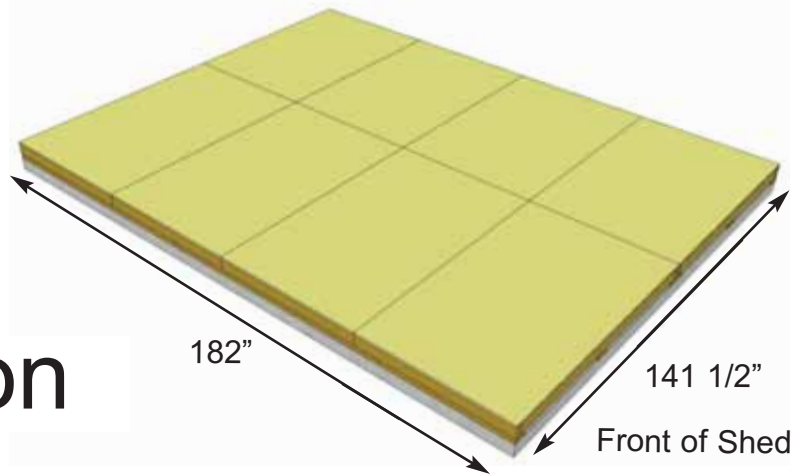

B. Wall Section

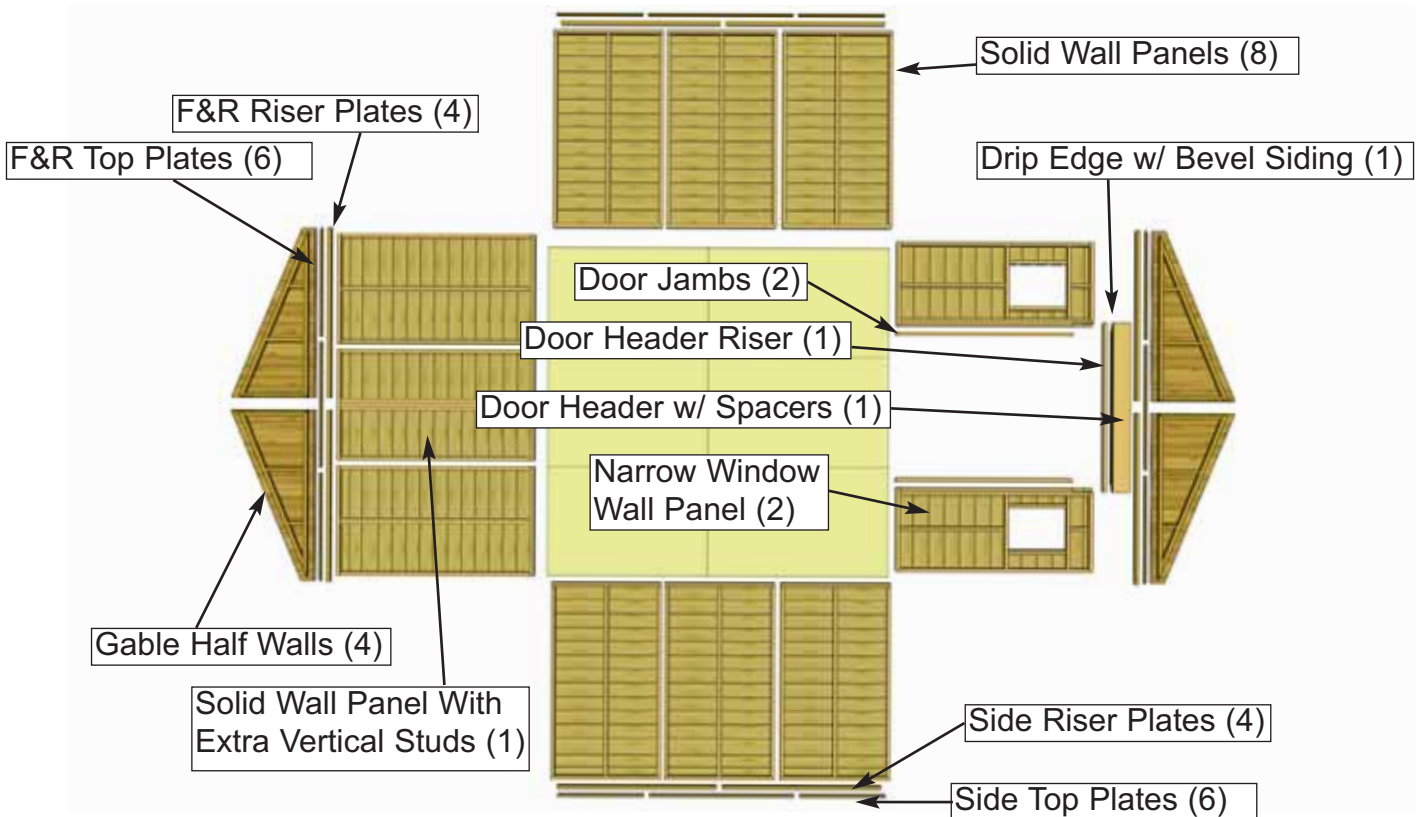

Important:
Pilot hole **ALL** 2x3 Wall Studs with 1/8" drill bit prior to screwing. This will make it much easier to attached together.

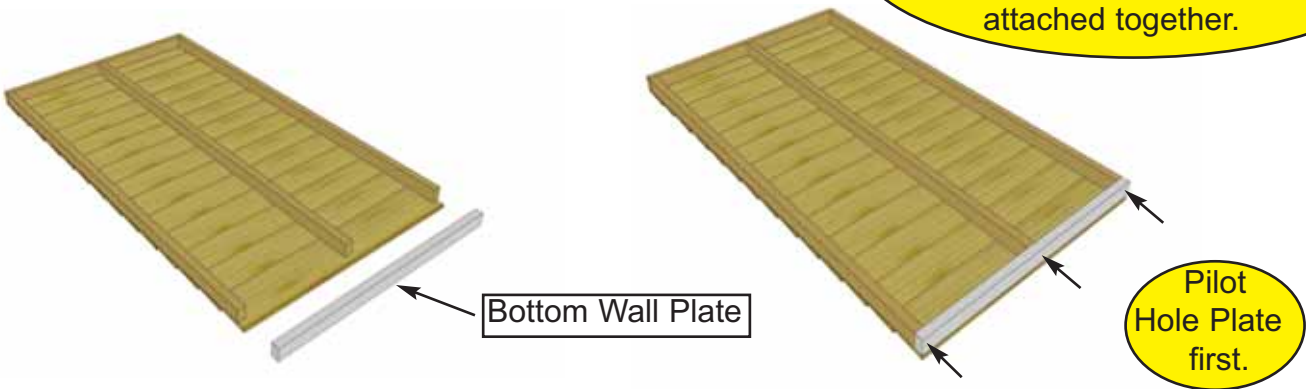

9. Starting with **Solid Wall Panels**, carefully lay panel face down. Position and attach **Wall Plate** to bottom of wall studs of each **Wall Panel** with **3 - 2 1/2" screws**. Position so plates are flush with framing. **Note:** Bottom Wall Plates may already be attached to some Solid Walls.

<p><u>Parts (Step 9)</u> Solid Wall Panels (45 1/2" x 81 3/4") x 8 Solid Wall Panel - Extra Studs (45 1/2" x 81 3/4") x 1 Bottom Wall Plates (1 1/2" x 2 1/2" x 45 1/2") x 9</p>

<p><u>Hardware (Step 9)</u> S1 - 2 1/2" Screws x 27 total</p>
--

Important: Make sure all walls are aligned in their upright position. If not, water may leak into your shed. Unsure if panel is facing up or down? check siding on window wall panel to match alignment.

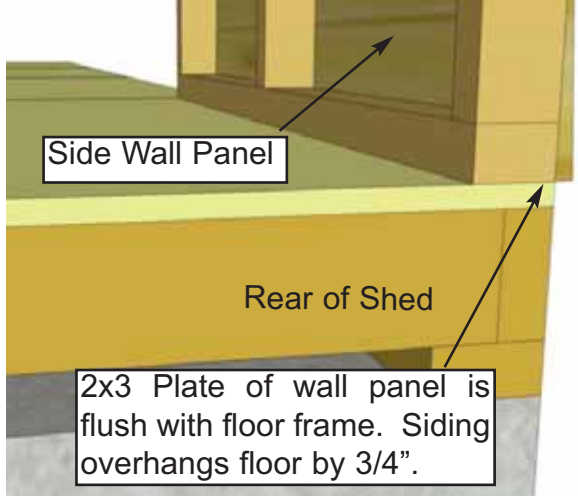
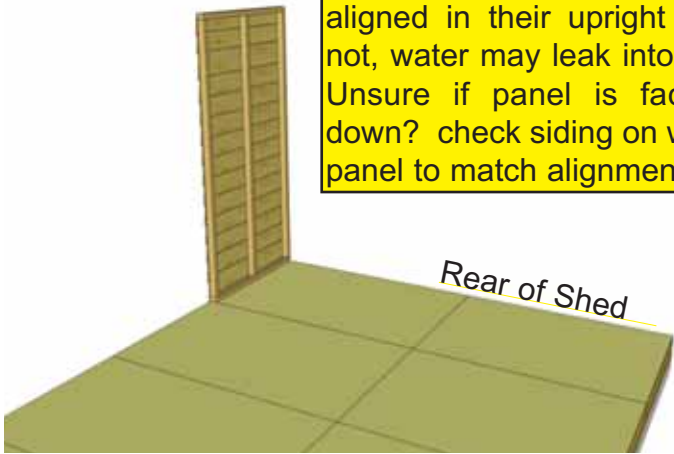

10. Starting at Rear Corner, position a **Solid Wall Panel** on top of plywood floor. Make sure panel is facing up. The **Side Wall Panels** will sit flush with floor frame with the front and rear panels sandwiched between them. **Note:** siding will overhang the floor by approx. 3/4".

<p><u>Parts (Step 10)</u> Solid Wall Panels (45 1/2" x 81 3/4") x 8 Solid Wall Panel - Extra Studs (45 1/2" x 81 3/4") x 1 Narrow Window Wall Panels (34 3/4" x 81 3/4") x 2</p>

<p><u>Hardware (Step 10)</u> S1 - 2 1/2" Screws x 39 total</p>

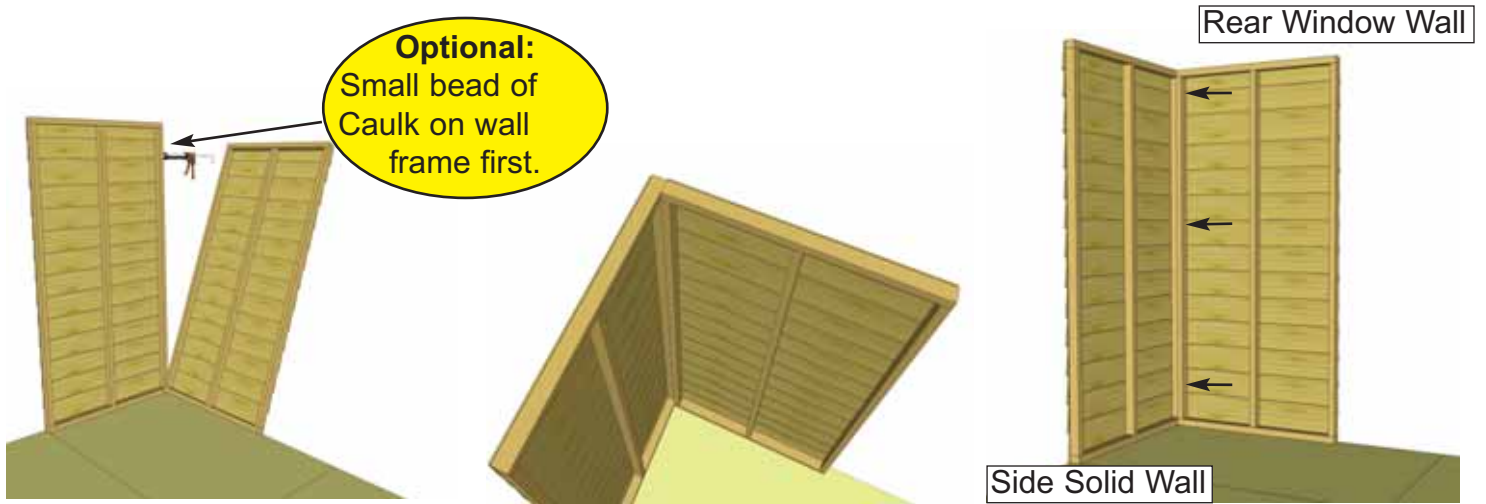

11. Position rear **Wall Panel** into place on plywood floor. Butt both vertical wall studs of side and rear walls together and attach with **3 - 2 1/2" screws**. Screw at the bottom, middle and top of stud to secure properly.

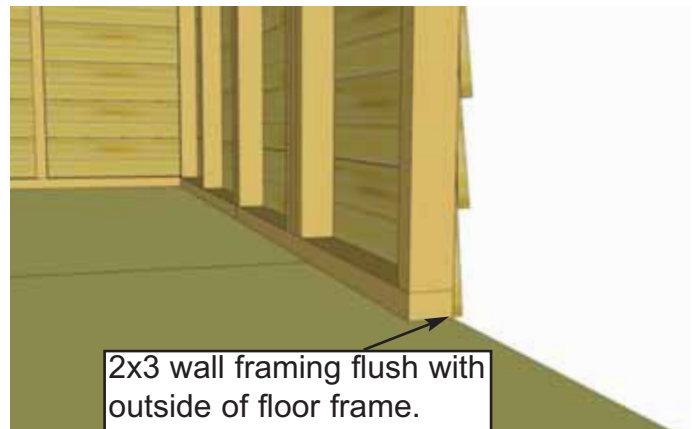

12. With the corner wall attachment complete, position a rear **Solid Wall Panel With Extra Vertical Studs** so bottom 2x3 wall framing is sitting flush with outside floor frame. Wall siding should overhang floor by approximately 3/4". Attach rear wall panel studs together as per **Step 11**.

13. Position the final Rear **Solid Wall Panel** on the floor. Position vertical wall studs together and attach as per **Step 11**.



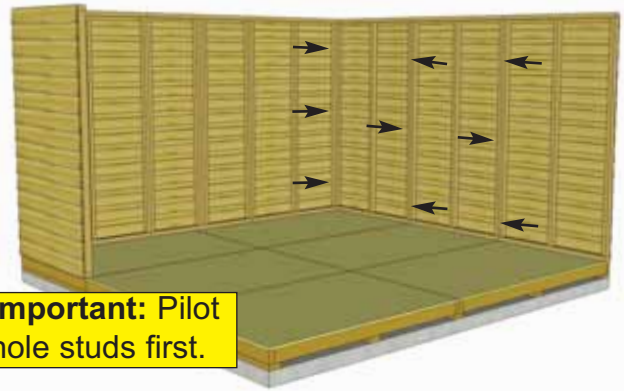
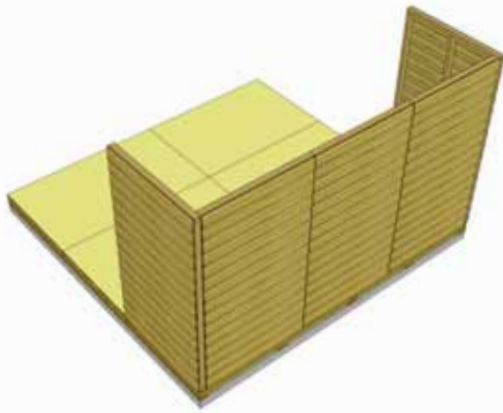

Important: Pilot hole studs first.

14. Attach a **Solid Wall Panel** in corner. Attach as per **Step 11**. Start positioning and securing remaining **Solid Walls**. Attach wall studs together as per **Step 11**.

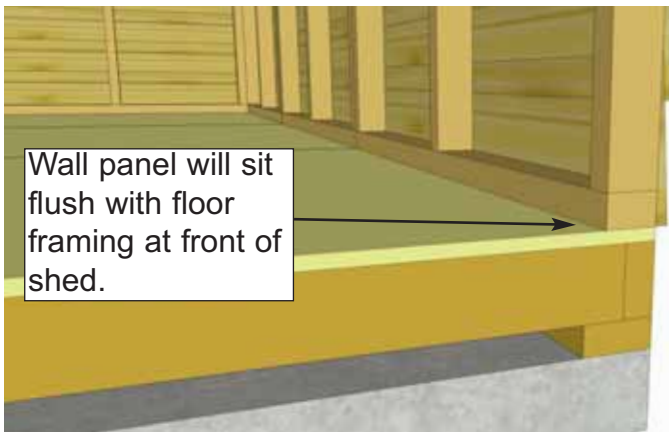

Wall panel will sit flush with floor framing at front of shed.



15. Complete attachment of left side **Solid Wall Panels**. At the front of the shed, side walls will sit flush with front floor framing.

Important: Remove the marked support block from Narrow Window Walls before installation to reveal notch for Door Header.

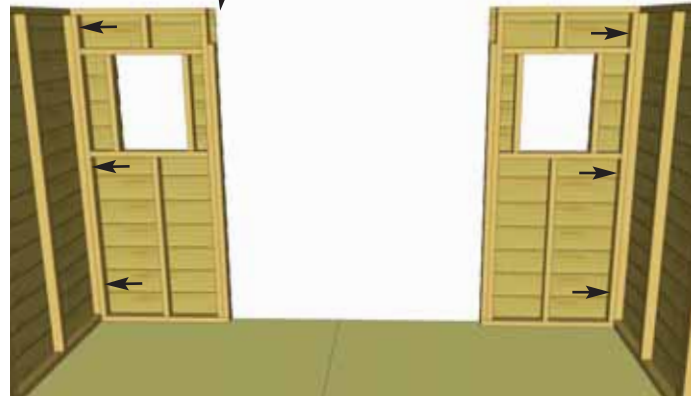
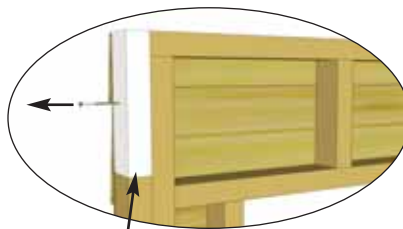

16. Secure remaining two **Narrow Window Walls** to both front corners of shed.

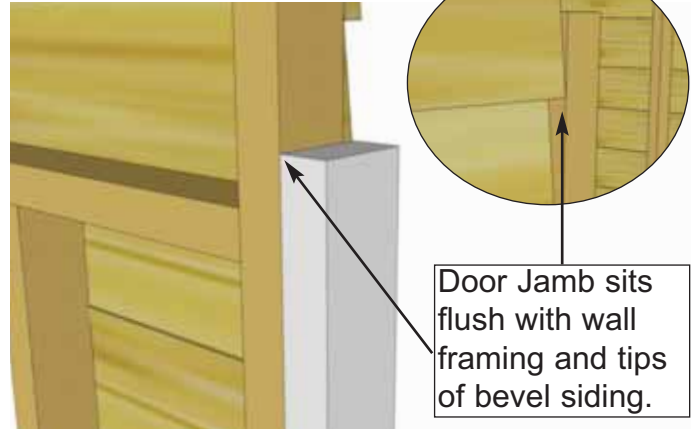

17. Locate **Vertical Door Jamb** and position flush against each wall panel stud. The Jamb is 3 1/2" wide and will sit flush to outside of wall siding. When positioned correctly, secure Jamb using **4 - 2 1/2" screws**.

Part (Step 17)
Vertical Door Jamb
 (1 1/2" x 3 1/2" x 73") x 2

Hardware (Step 17)
S1 - 2 1/2" Screws
 x 8 total

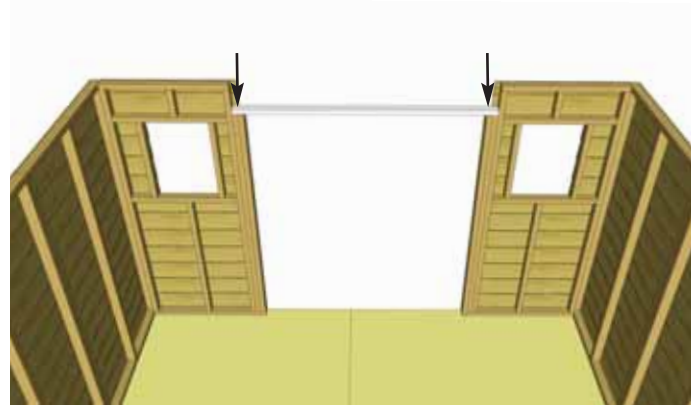
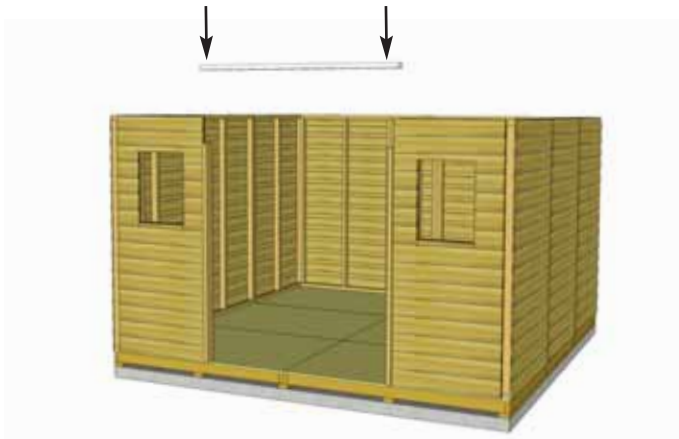

18. Position and attach **Door Header Riser** to **Door Jamb** and **Narrow Wall Panel** top framing. Header should fit flush with **Door Jamb** and Outside of **Narrow Wall Siding**. Attach with **4 - 2 1/2" screws**.

Part (Step 18)
Door Header Riser
 (1 1/2" x 2 1/2" x 70") x 1

Hardware (Step 18)
S1 - 2 1/2" Screws
 x 4 total

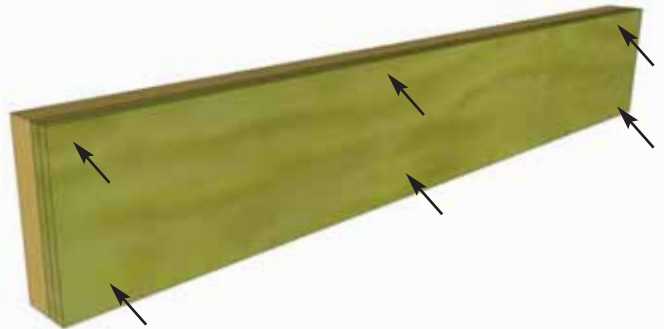

19. Locate **Door Header** and **Door Header Spacers**. Lineup three pieces together so they are flush to create a larger piece, attach with **6 - 2" screws**.

Part (Step 19 - 20)
Door Header
 (1 1/2" x 7 1/4" x 70") x 1
Door Header Spacer
 (1/2" x 7 1/4" x 70") x 2

Hardware (Step 19 - 20)
S3 - 2" Screws
 x 13 total

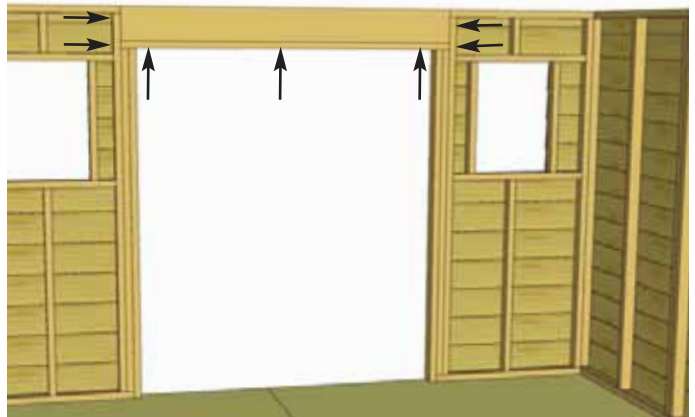
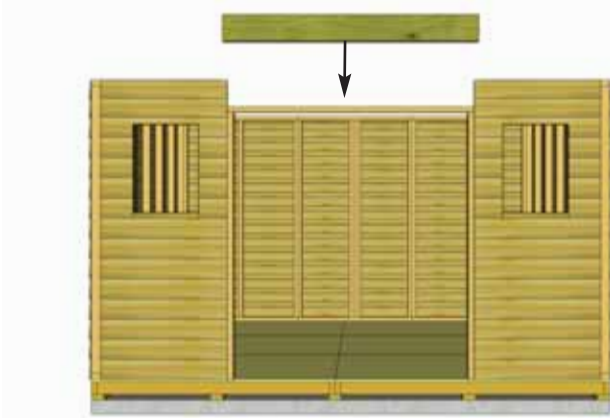

20. Place assembled **Door Header** onto **Door Header Riser** and attach with **7 - 2" screws**.

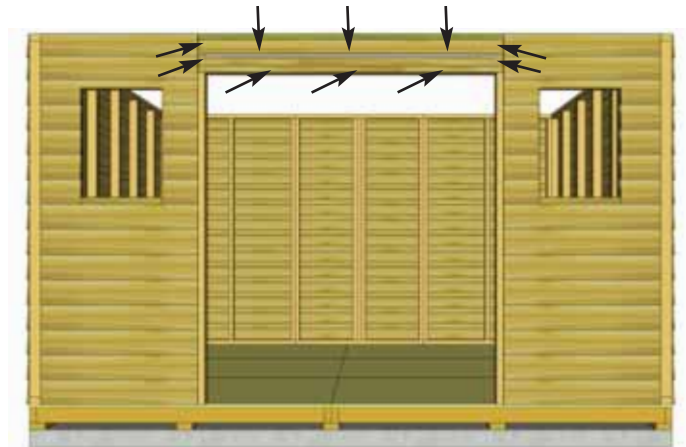
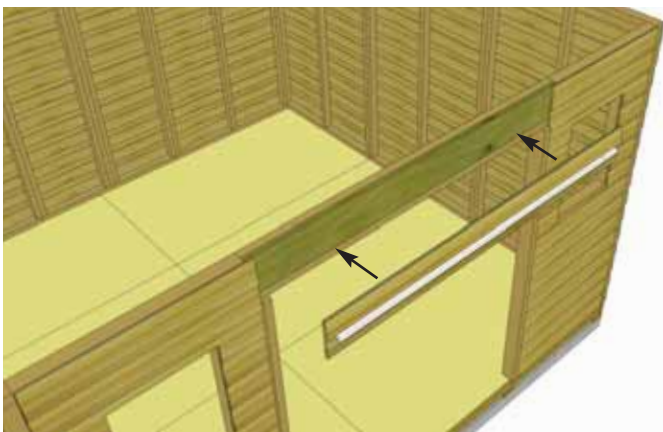

21. Locate **Drip Edge with Bevel Siding** attached. Attach to **Door Header Spacer** with **8 - 1 1/2" Finishing Nails**.

Part (Step 21)
Drip Edge w/ Bevel Siding
 (67") x 1

Hardware (Step 21)
N1 - 1 1/2" Finishing Nails
 x 10 total

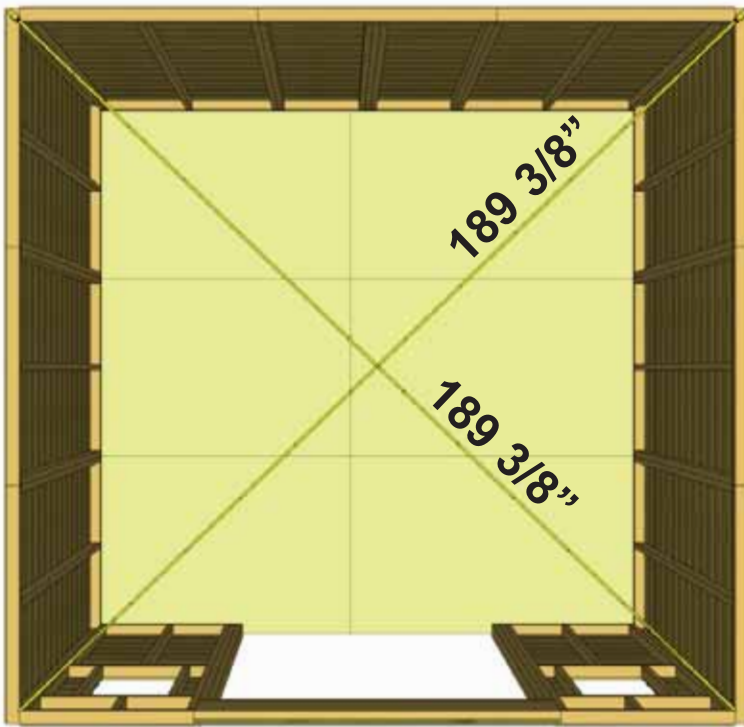

Advice: Prior to fastening walls and installing rafters, take time to confirm your walls are level, square and plumb.

Measure diagonal at top and bottom of walls corner-to-corner. This should be approximately 189 3/8". More importantly, if measurements are not within 1/4", your walls are not square. Adjusting now will make it easier to the roof section later.

Important: If walls are not lining up and appear higher or lower than each other, please check the level of your floor. You may need to make slight adjustments before proceeding.

22. When all walls are attached together, check alignment with the floor. Bottom wall framing should sit flush with outside of floor joists. When positioned correctly, fasten bottom wall plates to floor using **4 - 2 1/2" screws** per wall panel (48 total). **Confirm 64" wide door opening at bottom.**

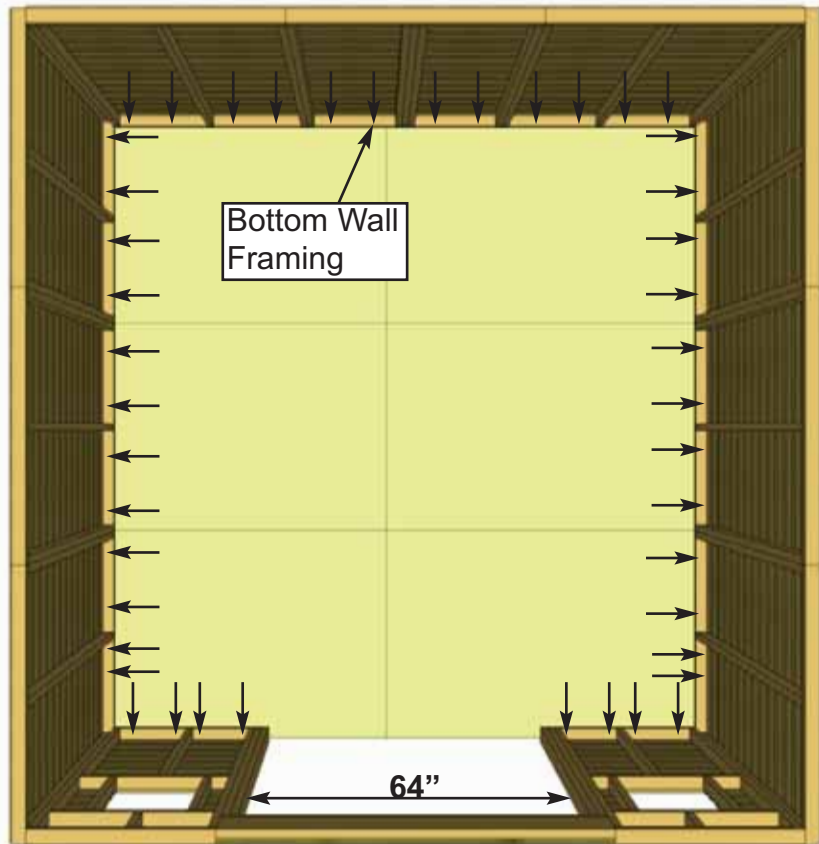

Angle screws into perimeter Floor Joists.

Optional: Caulking seams will help prevent moisture from entering your shed. Caulking is included to complete roof only. Additional Caulking may be required.

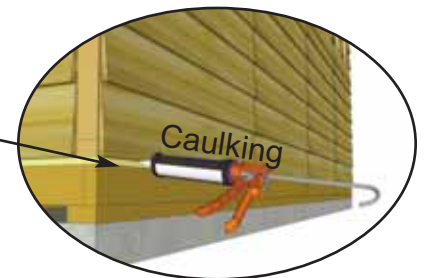

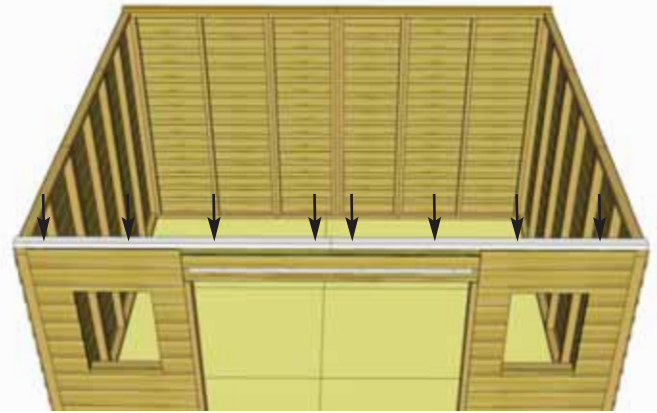
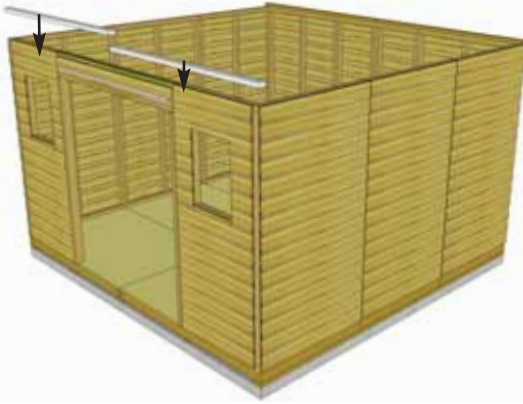

23. Position and attach **F & R Riser Plates** on top of Front and Rear **Wall Frames**. attach with **4 - 2 1/2" screws** each. Complete both front and rear of shed.

Parts (Steps 23)
F&R Riser Plates
 (1 1/2" x 2 1/2" x 70 3/4")
x 4

Hardware (Steps 23)
S1 - 2 1/2" Screws
 x 16 total



24. Position and attach **Side Riser Plates** with **6 - 2" screws** per piece. Complete both sides of shed.

Parts (Steps 24)
Side Riser Plates
 (1 1/2" x 2 1/2" x 65 3/4")
x 4

Hardware (Steps 24)
S3 - 2" Screws
 x 24 total

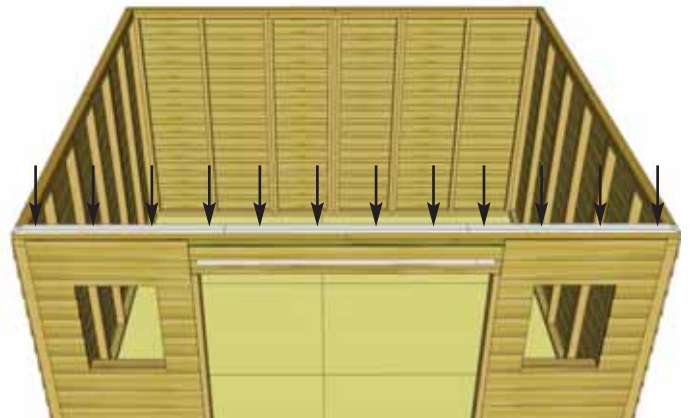
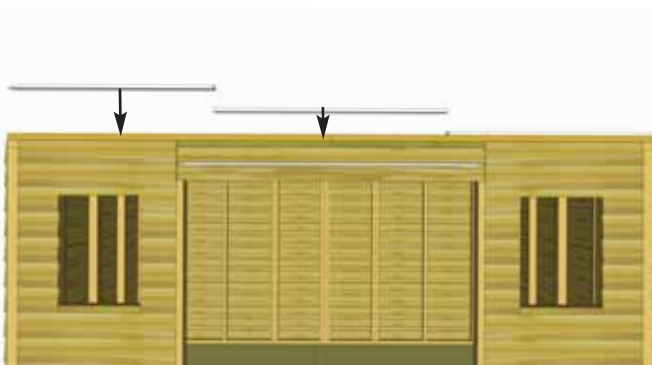

25. Position and attach **Front & Rear Top Plates**. There are two pieces with angle cut ends and one straight piece per side. Attach with **4 - 1 1/4" screws** per piece. Complete Front and Rear

Parts (Steps 25)
F&R Top Plates Angle
 (3/4" x 2 1/2" x 45") **x 4**
F&R Top Plates Straight
 (3/4" x 2 1/2" x 51 1/2") **x 2**

Hardware (Steps 25)
S2 - 1 1/4" Screws
 x 24 total

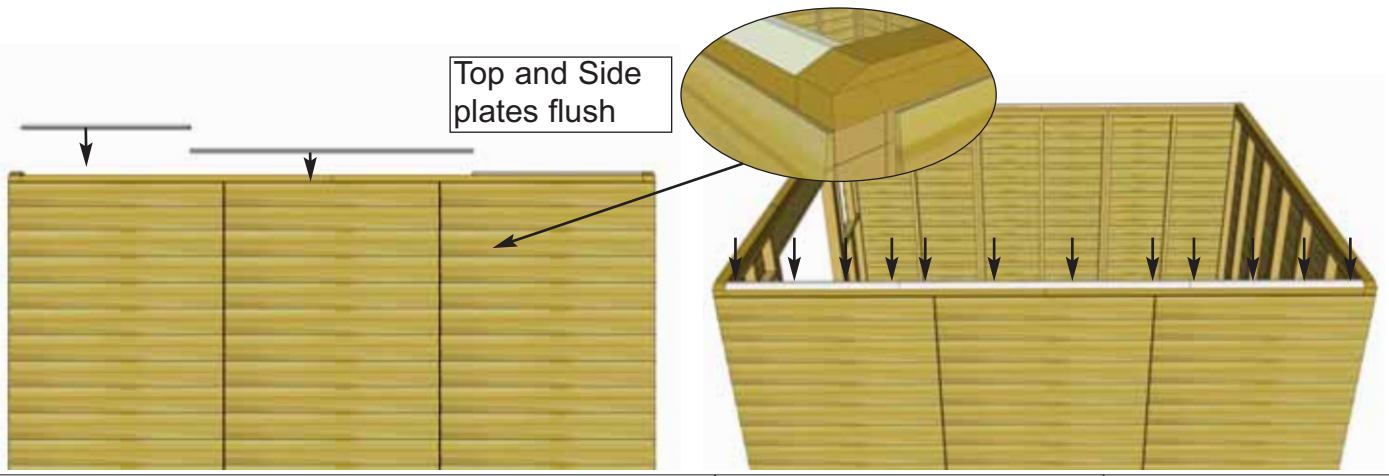

26. Position and attach **Side Top Plates** on **Side Riser Plates**. 35 3/4" side plates are on the outside with the 60" plate in the center. Angle of **Side Plates** should match angle of **F&R Top Wall Plates**. Attach each piece with **4 - 1 1/4" screws**. Complete both sides of shed.

Parts (Steps 26)
Side Top Plates
 (3/4" x 2 1/2" x 60") x 2
 (3/4" x 2 1/2" x 35 3/4") x 4

Hardware (Steps 26)
S2 - 1 1/4" Screws
 x 24 total

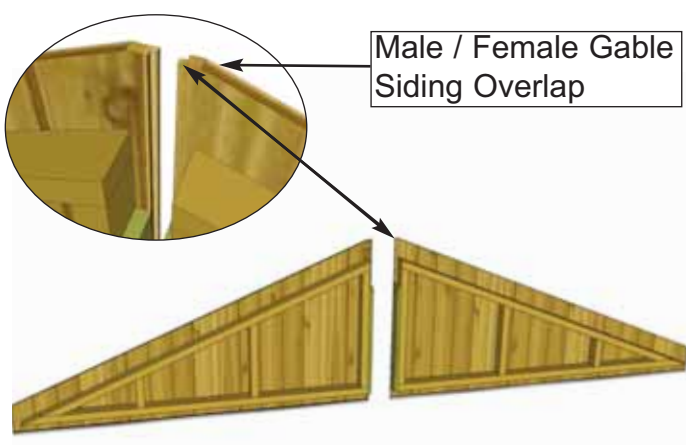

27. Locate Triangular **Gable Half Walls** for both sides of shed. Align framing and wall siding lap together. Screw center wall framing of each piece together with **4 - 2 1/2" screws**. Note: Prior to attaching, try each combination of Gables for best fit. Tip of Gables are separate pieces that need to be attached on in **Step 28**.

Parts (Steps 27-28)
Gable Half Walls x 4

Hardware (Steps 27-28)
S1 - 2 1/2" Screws
 x 8 total
S3 - 2" Screws
 x 8 total

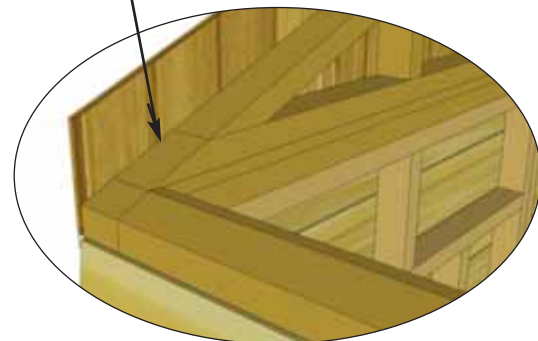
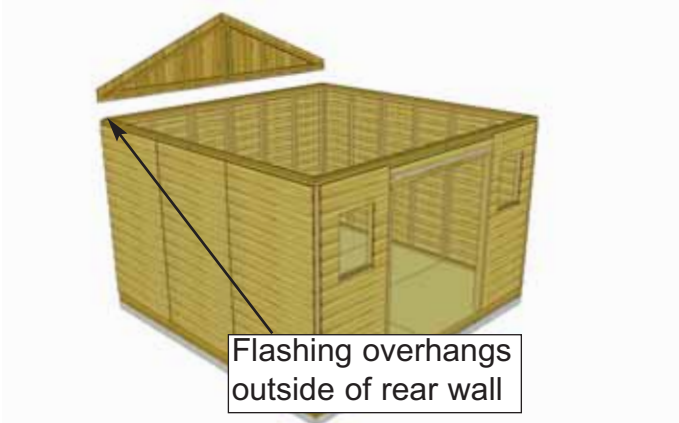

28. Place completed **Gable Section** so framing sits flush with the inside of the **Top Wall Plate**. It should also be centered side-to-side on the **Top Wall Plate**. Gable Flashing overhangs wall on the outside. Temporarily attach **Gables** to **Top Wall Plate** with **4 - 2" screws**. Gables may need slight adjustment in **Step 39** when attachment will be completed with an additional 6 screws. Screw from the bottom of **Gable** framing down into **Top Wall Plate** and **Wall Framing**. Complete **Gable** positioning and attachment on the other side. **Hint:** Use a straight edge to check the angle of the Gable framing and Top Plate. Both angles should lineup at 22.5°. Attach Gable tip to shed with **2 - 1 1/2" Finishing Nails** as shown above.

C. Rafter Section

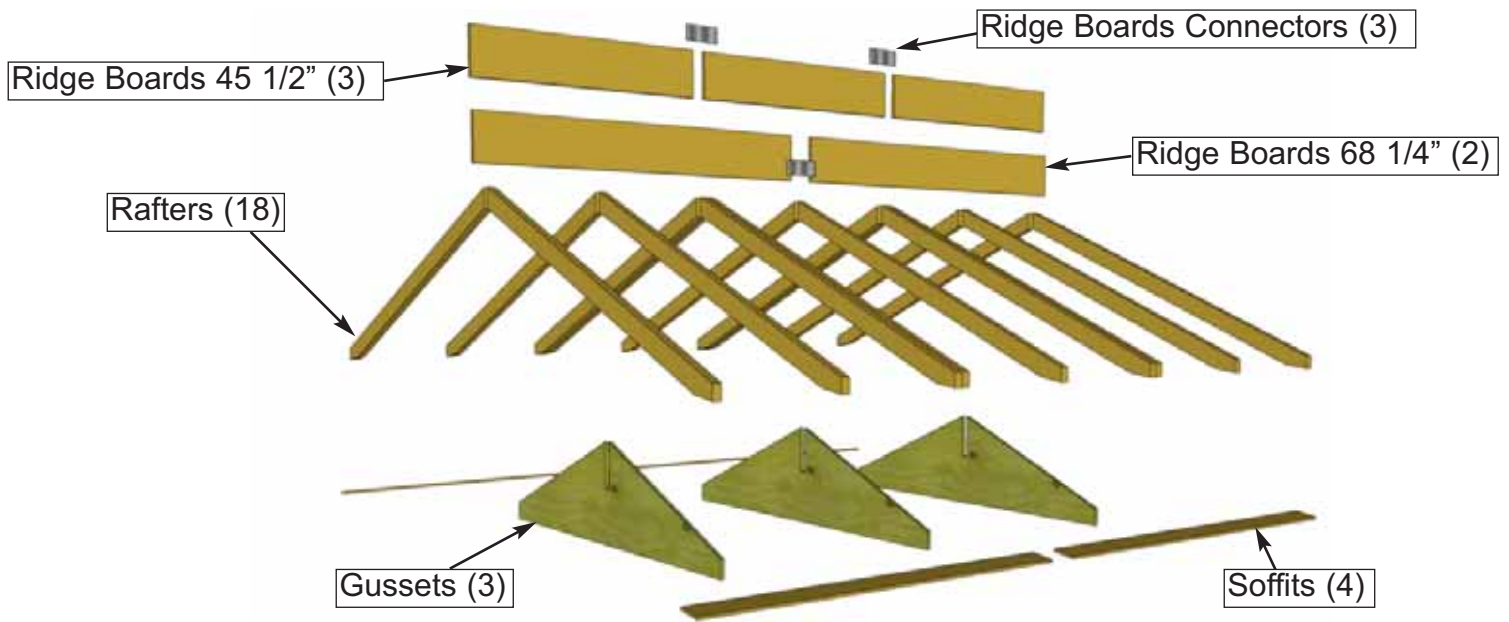

Important: Locate all parts necessary to assemble each Rafter Section prior to beginning.

<p>Parts for first Rafter Section: 2 - 3/4" x 9 1/4" x 68 1/4" - Ridge Boards 9 - 1 1/2" x 3 1/2" x 80 7/8" - Rafters 2 - 1/2" x 4 1/2" x 68 1/4" - Soffits * Must complete 2 Rafter Sections</p>	<p>Parts for second Rafter Section: 9 - 1 1/2" x 3 1/2" x 80 7/8" - Rafters 3 - 3/4" x 9 1/4" x 45 1/2" - Ridge Board 2 - 1/2" x 4 1/2" x 68 1/4" - Soffits</p>
<p>Remaining Rafter Pieces: 3 - 3/4" x 80" x 19 3/4" - Gussets</p>	

Follow **Steps 29- 42** to Assemble Rafter Sections. Make sure to complete on a flat, level surface.

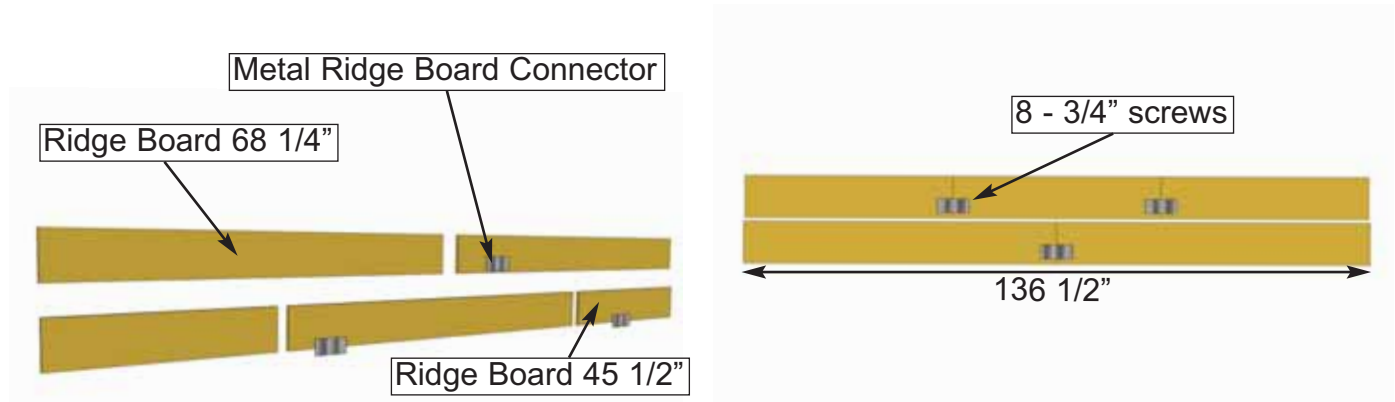

<p>29. Locate Ridge Boards and attach together using Metal Ridge Board Connectors and 8 - 3/4" screws evenly spaced on boards per connector. Place connector approximately 1 1/4" up from bottom of Ridge Board. Total length when connected is 136 1/2". Complete two Ridge Boards.</p>	<p>Parts (Steps 29) Ridge Boards (3/4" x 9 1/4" x 68 1/4") x 2 (3/4" x 9 1/4" x 45 1/2") x 3</p>	<p>Hardware (Steps 29) SS2 - 3/4" Screws x 24 total Y9 - Metal Ridge Connector x3 total</p>
--	---	--

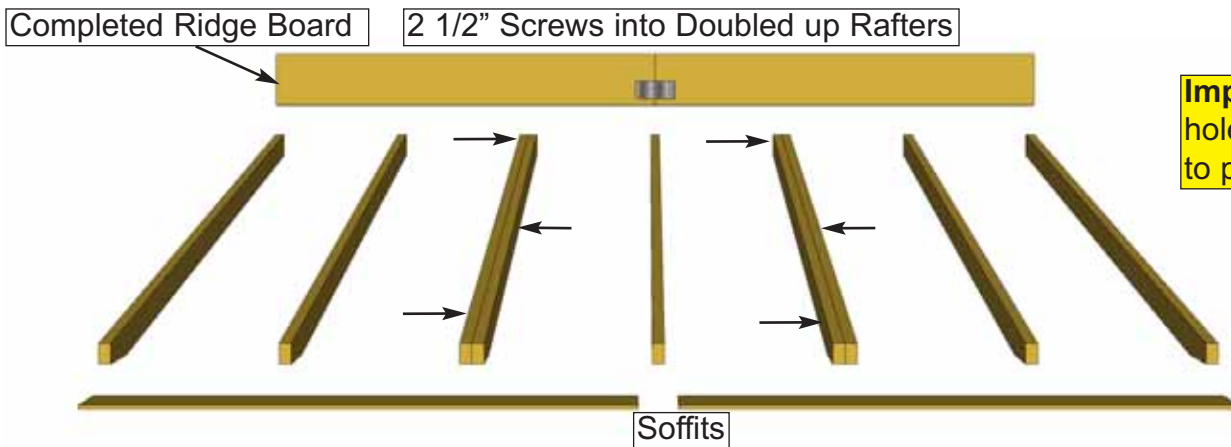

Important: Pilot hole Ridge Board to prevent splitting

30. Lay out **9 Rafters**, **2 Soffits** and the completed **Ridge Board** from **Step 33** on level ground as shown. Double up **Rafters** as illustrated. Screw doubled up **Rafters** together with **3 - 2 1/2" screws**. **Note:** completed rafter section will be flipped over in **Step 39**.

Parts (Steps 30 - 33)

Ridge Boards

- (3/4" x 9 1/4" x 45 1/2") x 3
- (3/4" x 9 1/4" x 68 1/2") x 2
- Rafters**
- (1 1/2" x 3 1/2" x 80 7/8") x 18
- Soffits**
- (1/2" x 4 1/2" x 68 1/4") x 4

Hardware (Steps 30 - 33)

- S1 - 2 1/2" Screws**
- x 18 total
- S3 - 2" Screws**
- x 48 total
- S2 - 1 1/4" Screws**
- x 48 total

Completed Ridge Board

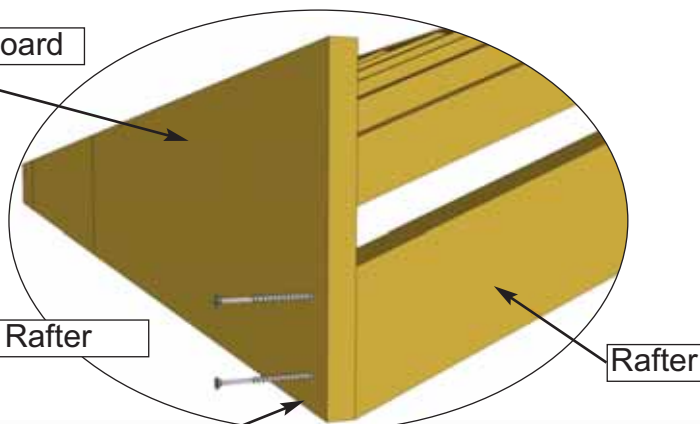

Important: Measure 20 1/2" spacing accurately.

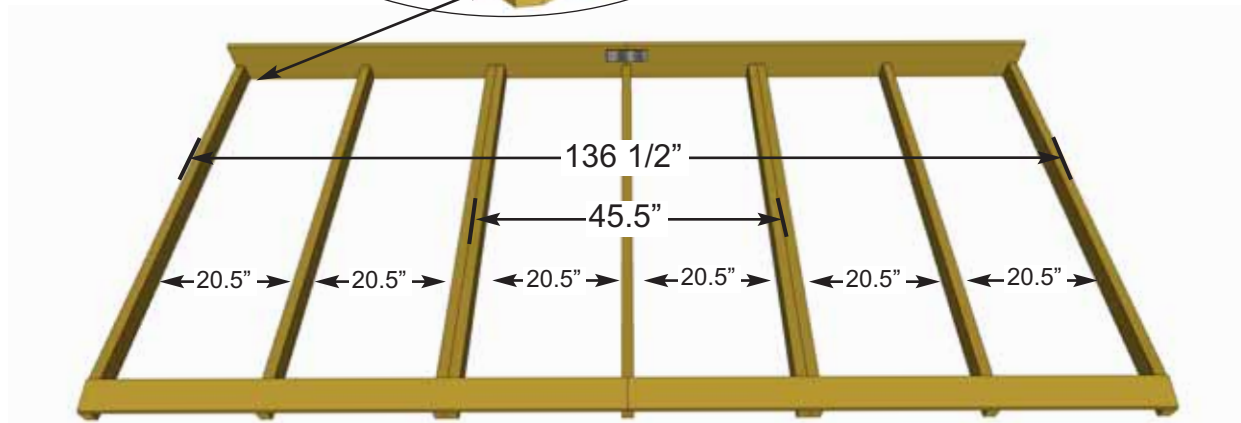

31. Attach completed **Ridge Board** to ends of both outside **Rafters** with **2 - 2" screws** per end. Measure and position interior **Rafters** as illustrated above. When positioned correctly, attach **Ridge Board** to remaining **Rafters** with **2 - 2" screws** per rafter end. **Important:** Pilot Hole **Ridge Board** to prevent splitting.

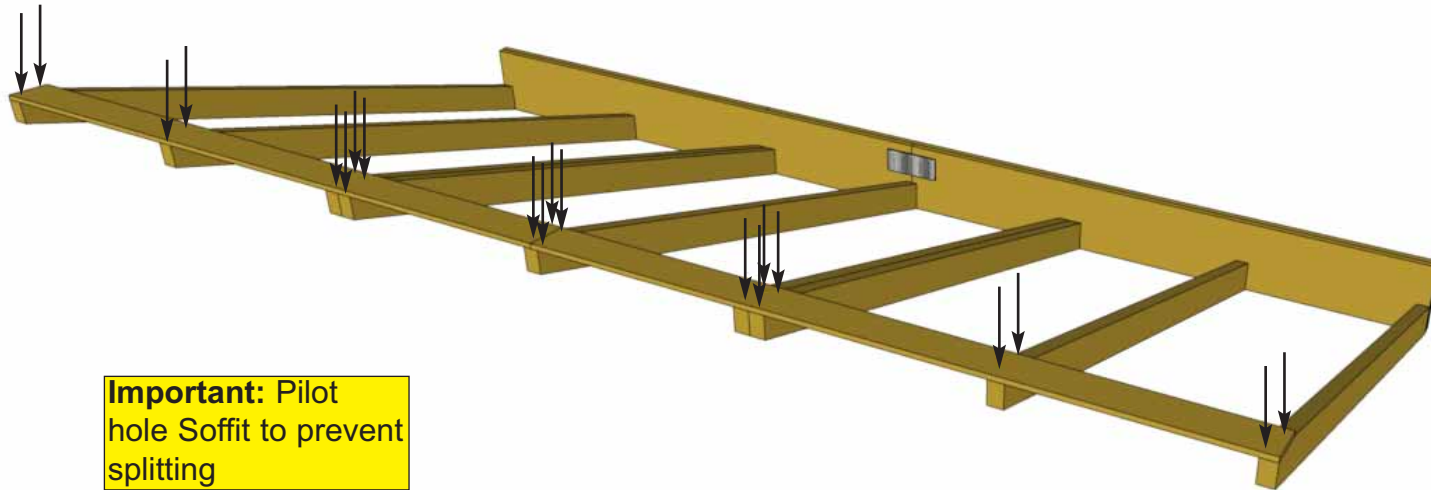

Important: Pilot hole Soffit to prevent splitting

32. Attach end **Soffit** Board flush to ends of outside **Rafters** with **2 - 1 1/4" screws** per **Rafter** end. Complete both outside **Rafter/Soffit** connections first. Measure and position interior **Rafters** as illustrated above. When positioned correctly, attach **Soffits** to remaining **Rafters** with **2 - 1 1/4" screws/rafter**. **Important:** Pilot Hole **Soffits** to prevent splitting.

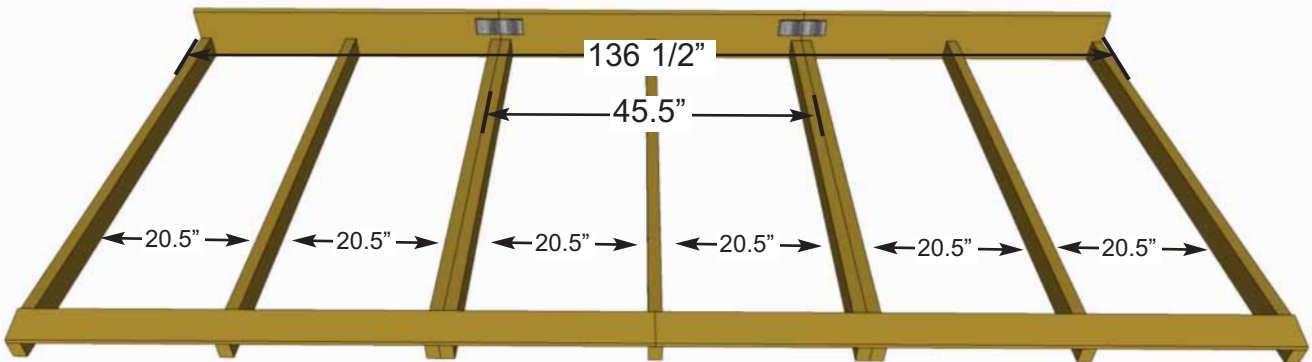

33. Complete second **Rafter** section following **Steps 30 - 32**.



34. With some helpers flip over each **Rafter** section so they can be lifted onto the shed. **Soffits** should now be on the ground. Prepare to lift onto **Wall** and **Gable Frame**

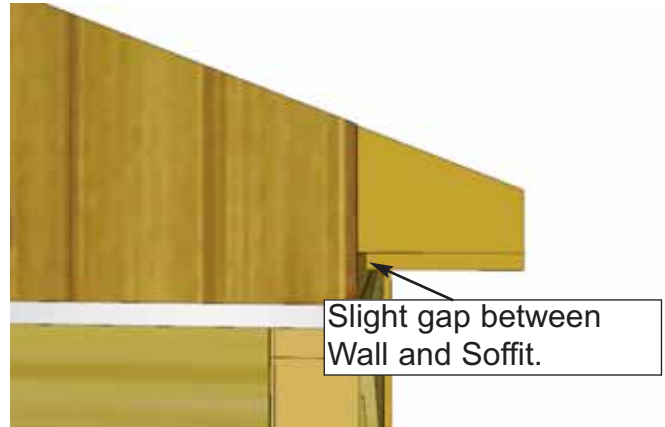
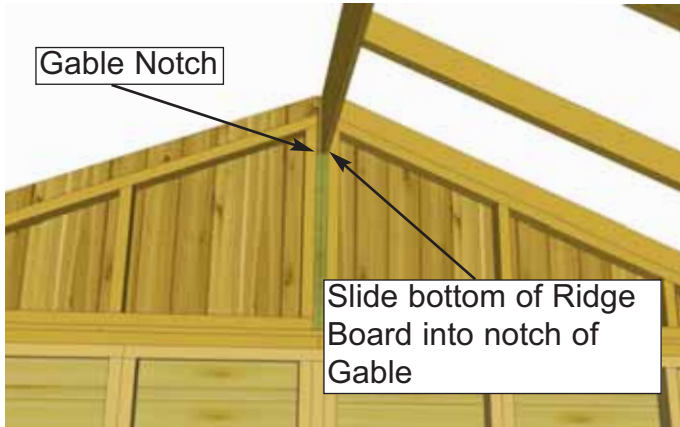
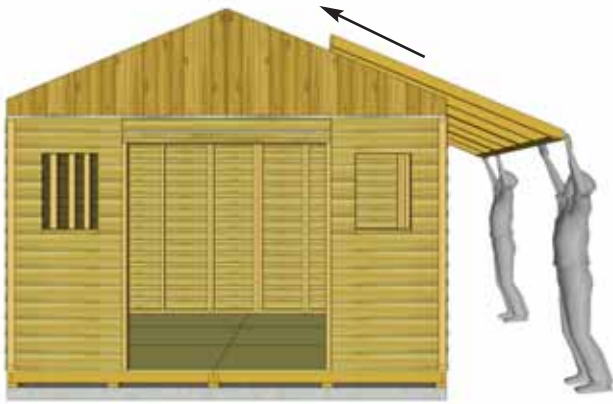

35. With the assistance of two or more helpers and some ladders, slide first **Rafter Section** up onto **Gable Framing** until bottom of **Ridge Board** slips into gable notch. Position **Rafters** so they sit evenly on **Gable Framing** from side to side. Where **Wall** and **Soffit** meet, a small gap may appear. Confirm all **Rafters** are resting on **Top Plate**.

Ensure Ridge Boards are flush with one another.

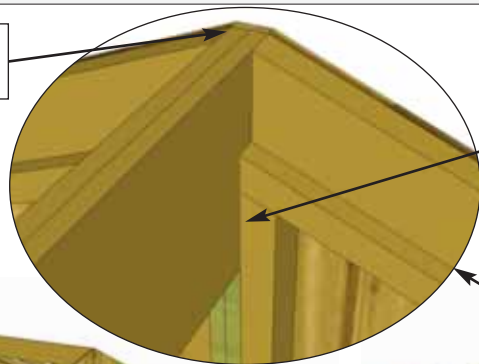

Bottom of Ridge Board fits in gable notch.

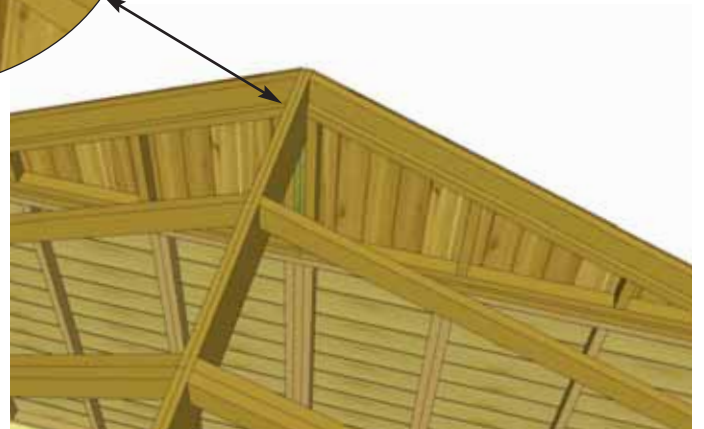

36. Lift second **Rafter Section** up and place on **Gable Framing**. Slide **Rafter Section** up on framing until bottom of **Ridge Board** slips into Gable notch. **Soffit** will sit approximately 1/8" away from wall as per **Step 35**.

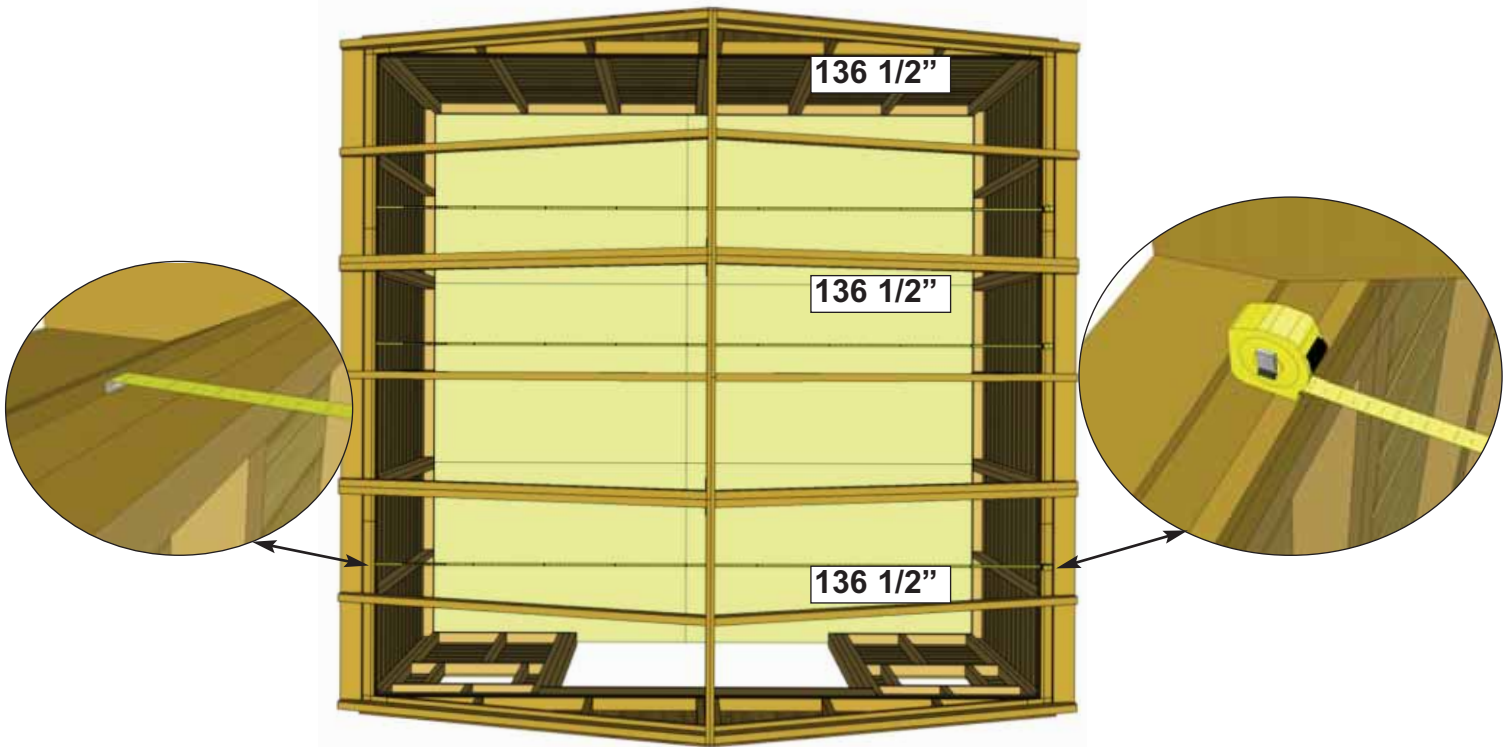

37. Take the inside-to-inside measurement between **Top Wall Plates** and **Bottom Wall Plates** at the front, middle, and rear of your shed. These measurements should each be approximately 136 1/2", but more importantly, if they are not within 1/4" of each other, your walls are not square.

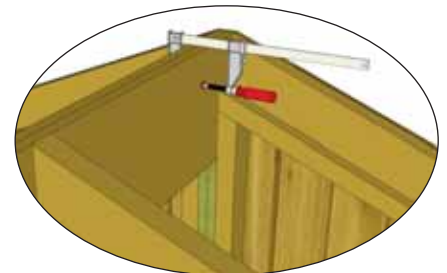

Advice: It may be helpful to use a clamp to help hold Ridge Boards together flush while screwing.

38. Where **Ridge Boards** meet, press together and secure with **12 - 1 1/4" screws** per side. We recommend using a clamp to hold the **Ridge Boards** together flush while screwing. Stagger screw position vertically on **Ridge Board** to create a stronger connection. Complete both sides, Important: if there is a gap between **Ridge Boards**, try pushing side walls closer together from outside. Walls should be 136 1/2" apart at top from inside of wall plate to wall plate as per **Step 40**.

Hardware (Steps 38)
S2 - 1 1/4" Screws
 x 24 total



Important: If Gable framing does not line up with Rafters, remove temporary 2" screws from Gable framing. Re align gable and then secure.

39. With both **Rafter Sections** correctly aligned, secure **Gable Framing** to both outside **Rafters** with **8 - 2" screws** per side at top and with **8 - 2" screws** into **Top Wall Plates** at bottom.

Hardware (Steps 39)
S3 - 2" Screws
 x 32 total

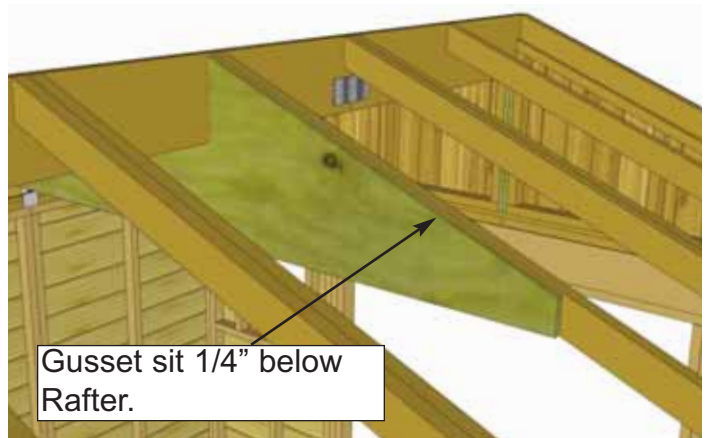

40. Start by attaching one **Gusset** onto the middle **Rafters** as illustrated. Attach only **1 - 2" screw** per side now. **Important:** Pilot hole **Gussets** to prevent splitting.

Parts (Steps 40 - 41)
Gussets
 (3/4" x 80" x 19 3/4") x 3

Hardware (Steps 40 - 41)
S3 - 2" Screws
 x 36 total

Important: Before attaching remaining Gussets, recheck the inside-to-inside wall measurements are done as in **Step 37**. Use a level to check they are square.



41. Once walls are confirmed to be square and plumb, attach the remaining 3 **Gussets** with **10 - 2" screws** per **Gusset**. **Gussets** attach to single **Rafters**. Attach remaining screws to **Gusset** that was attached in **Step 40**. **Important:** Pilot hole ends of **Gusset** to prevent splitting.

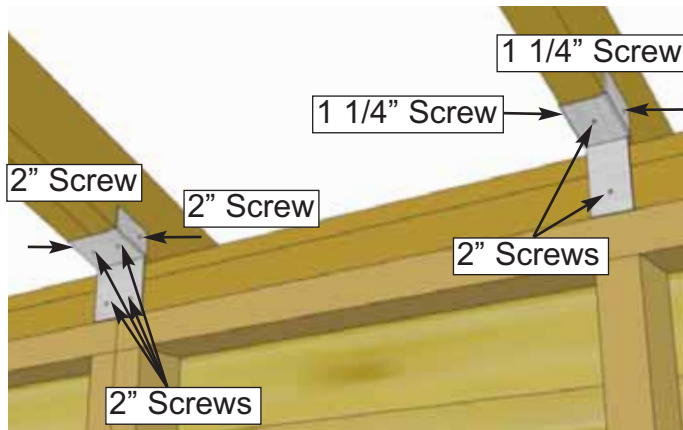

42. Attach all Single and Double **Rafter Brackets** where **Rafters** meet **Top Wall Plates** inside of shed. Attach with **2 - 1 1/4" screws** and **2 - 2" screws** per Single **Rafter Bracket** and **6 - 2" screws** per Double **Rafter Bracket**.

Hardware (Steps 42)

Y30 - Single Rafter Bracket
x 6 total

Y31 - Double Rafter Bracket
x 4 total

S2 - 1 1/4" Screws
x 12 total

S3 - 2" Screws
x 36 total

D. Roof Section

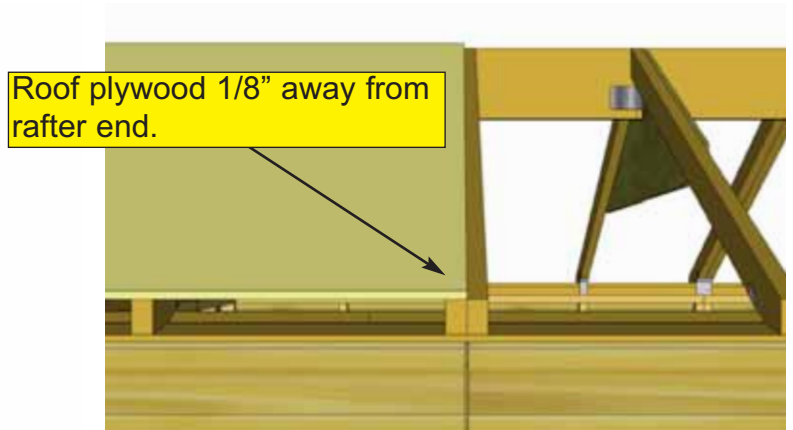
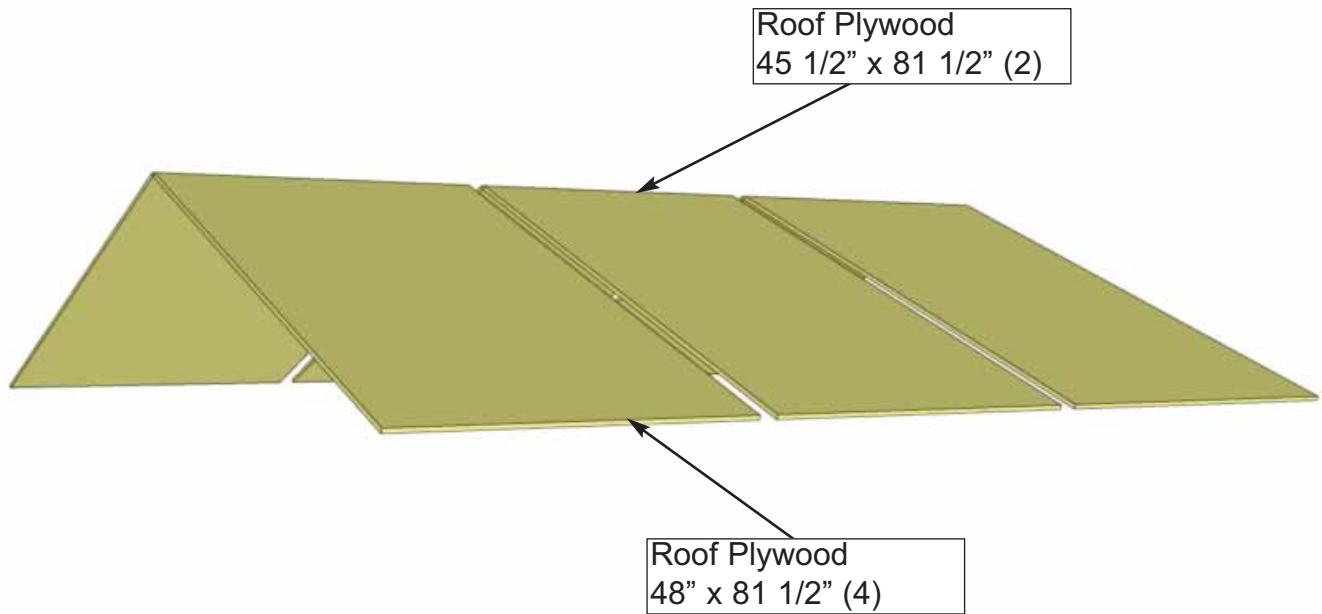

43. Lift and place first piece of roof plywood onto roof rafters so plywood is even on doubled up rafter and 1/8" away from end of rafter.

Parts (Steps 43 - 46)
Roof Plywood
 (5/8" x 48" x 81 1/2") x 4
Roof Plywood
 (5/8" x 45 1/2" x 81 1/2") x 2

Hardware (Steps 43 - 46)
S2 - 1 1/4" Screws
 x 112 total

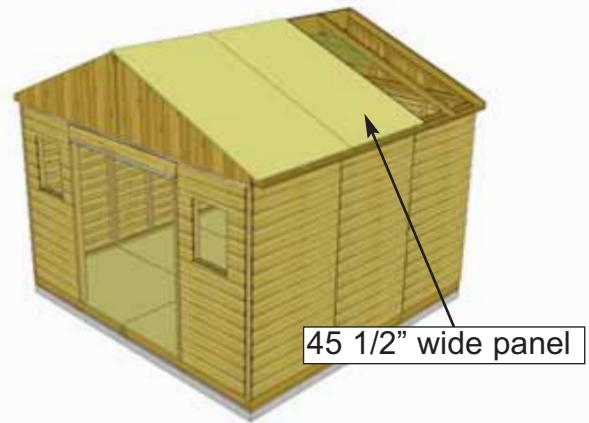
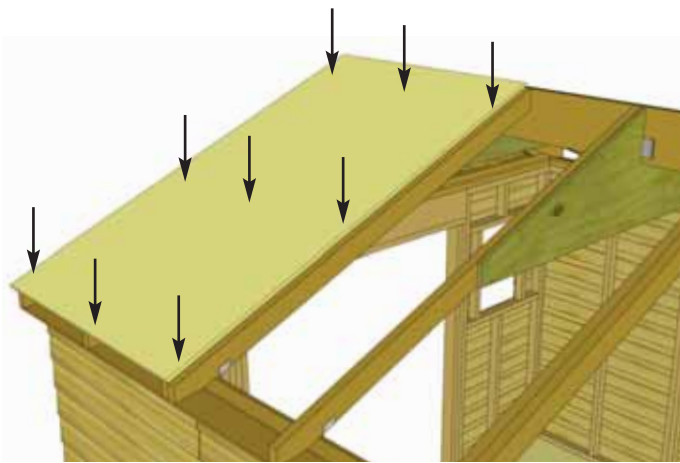

44. Position panel so roof plywood sits evenly on doubled up rafters. screw panel to rafters with **9 - 1 1/4" screws**. Lift up next panel and position evenly on rafters. Note center panels are 45 1/2"w.

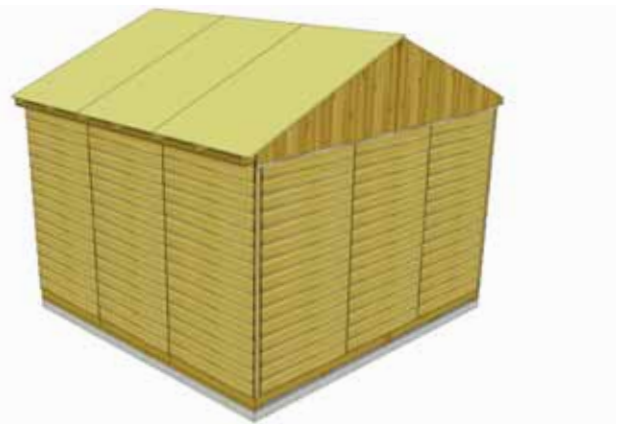
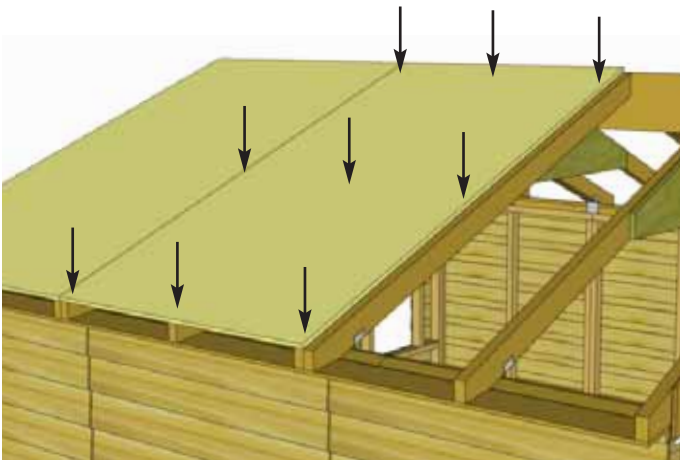

45 . Attach 2nd panel as per **Step 44** with **9 - 1 1/4" screws**. Lift and place 3rd panel onto rafters.

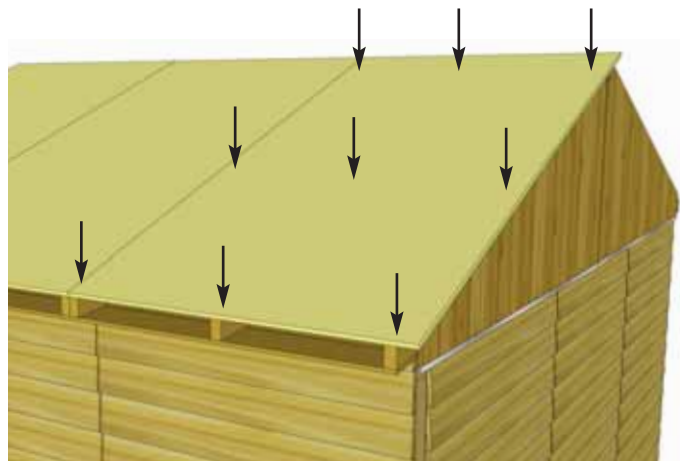

46 . Attach 3rd panel as per **Step 44** with **9 - 1 1/4" screws**. Switch sides of roof and repeat **Steps 43 - 46** to secure second half of roof.

E. Miscellaneous Section

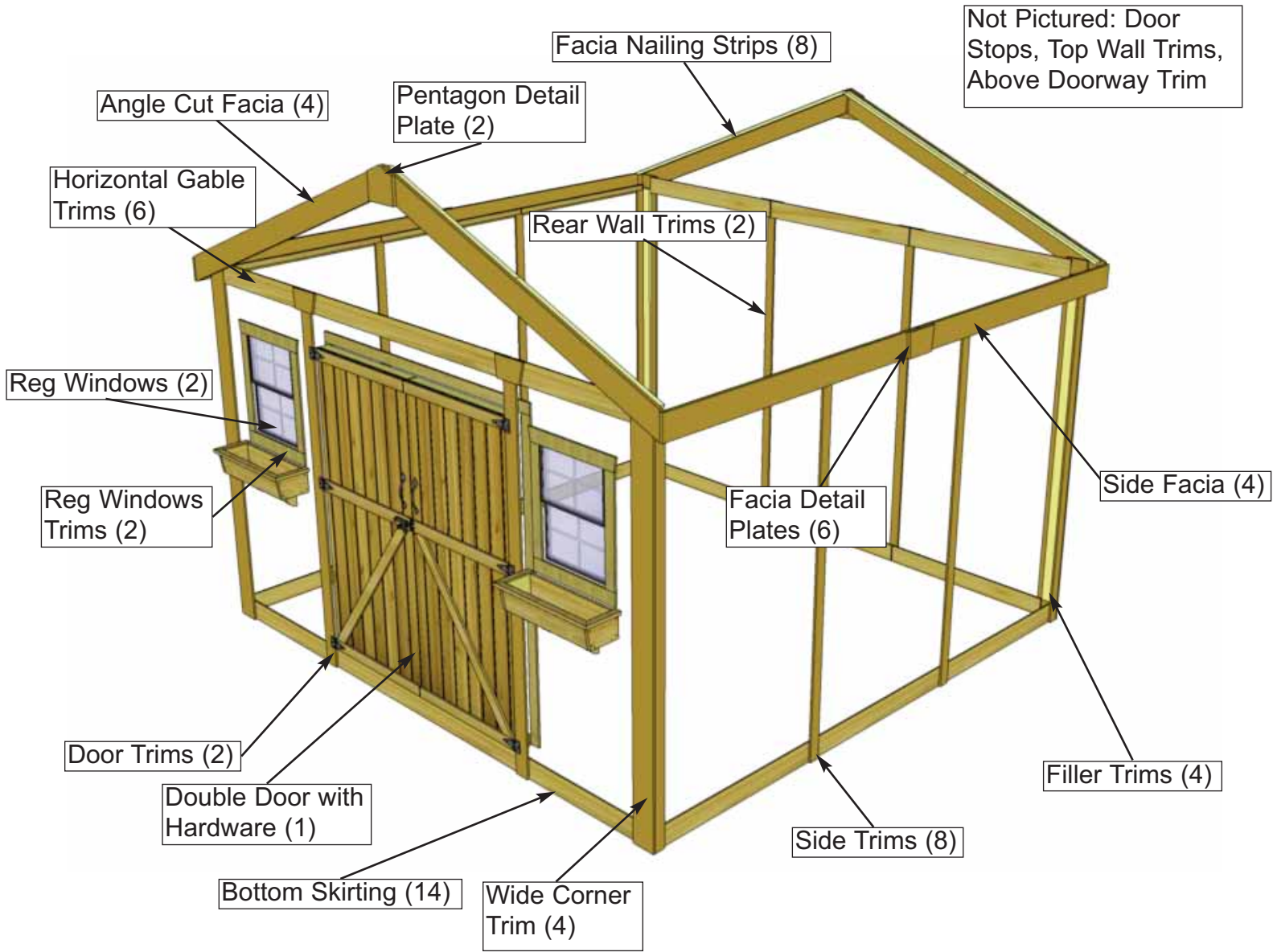

Expert Advice: When installing trim, sort pieces according to color and pieces that are most pleasing to the eye. Start with least visible side and use the least desirable pieces first. Install trim to most visible sides as your skill installing trim improves.



47. Attach **Bottom Skirting - Bevel** around the base of the shed. Skirting will hide floor framing. Gaps on outside will be covered by trim pieces later. Start with front and rear skirting pieces first and attach with **4 - 1 1/2" finishing nails** per piece.

<p><u>Hardware (Step 47)</u> 1 1/2" - Finishing Nails x 36 total</p>
<p><u>Parts (Step 47)</u> Bottom Skirting-Bevel (3/4" x 4 1/2" x 45 1/4") x 9</p>



48. Attach **Bottom Skirting - Bevel** below the two front **Narrow Window Walls**. Attach with **4 - 1 1/2" finishing nails** per piece.

<p><u>Parts (Step 48)</u> Bottom Skirting-Bevel (3/4" x 4 1/2" x 33 3/4") x 2</p>
--

Hardware (Step 48)
N1 - 1 1/2" - Finishing Nails
 x 8 total



49. Attach **Bottom Skirting - Bevel** below the doorway. Attach with **6 - 1 1/2" finishing nails** per piece.

<p><u>Parts (Step 49)</u> Bottom Skirting-Bevel (3/4" x 4 1/2" x 68 1/2") x 1</p>
--

Hardware (Step 49)
N1 - 1 1/2" - Finishing Nails
 x 6 total

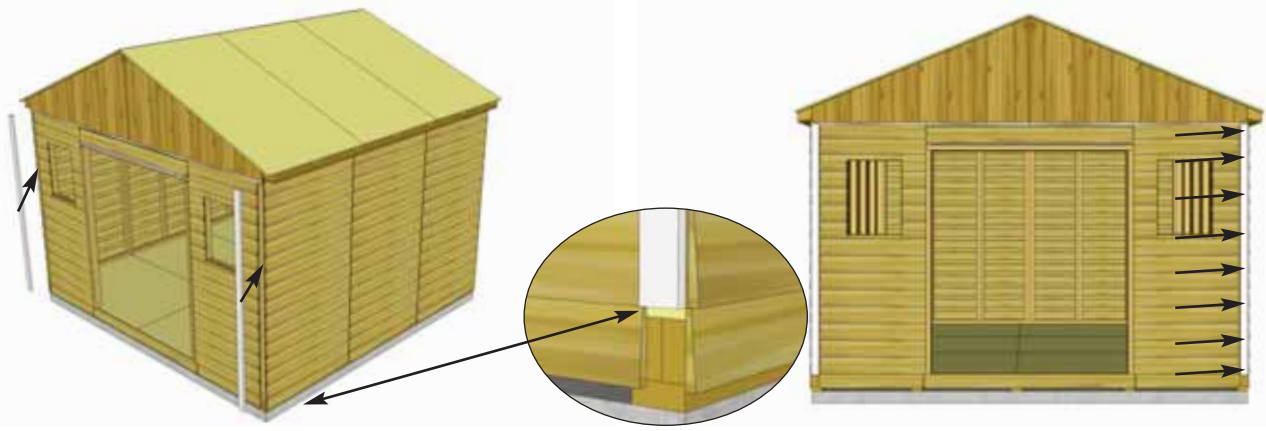

50. Attach **Filler Trim** to front and rear walls in each corner. Attach with **8 - 1 1/2" Finishing Nails** per piece. Strips are positioned flush with bottom skirting.

Parts (Step 50)
Filler Trims
 (7/8" x 2 1/2" x 81 3/4") x 4

Hardware (Step 50)
N1 - 1 1/2" Finishing Nails
 x 32 total

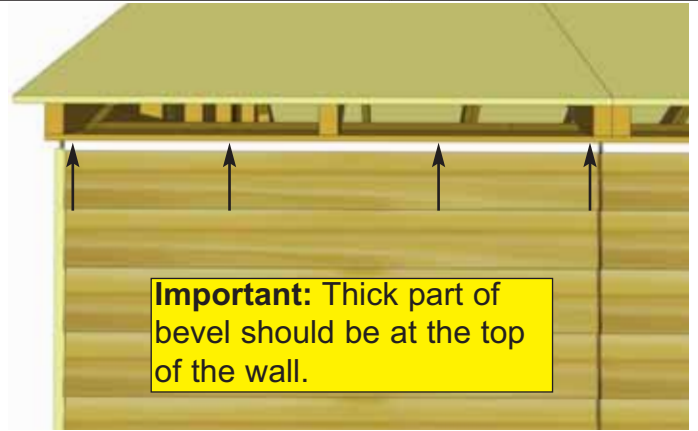

51. Trim out side walls by attaching **Top Wall Trim**. Position with thick end of Bevel downwards at top of wall, tight against Soffits. Attach with **4 - 1 1/2" Finishing Nails** per piece. Complete both sides.

Parts (Step 51)
Top Wall Trim
 (3/4" x 1 1/2" x 45 1/4") x 6

Hardware (Step 51)
N1 - 1 1/2" Finishing Nails
 x 24 total



52. Locate **Horizontal Gable Trims** for both front and rear of shed. Position equally over Gable and Wall seam. Attach each piece with **5 - 1 1/2" Finishing Nails**.

Parts (Step 52)
Horizontal Gable Trims - Bevel
 (3/4" x 4 1/2" x 45 1/4") x 3 **Rear**
 (3/4" x 4 1/2" x 68 1/2") x 1 **Door**
 (3/4" x 4 1/2" x 32 1/4") x 2 **Window Walls**

Hardware (Step 52)
N1 - 1 1/2" Finishing Nails
 x 30 total

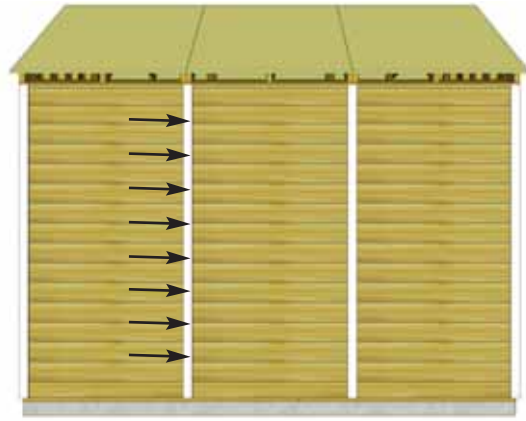

53. Attach **Side Trims** to cover side wall seams and in the corners. align tight underneath **Soffit** and even with **Filler Trims**. Attach each with piece with **8 - 1 1/2" Finishing Nails**. Note: Trim may sit slightly below **Bottom Skirting**.

Parts (Step 53)
Side Trims
(1/2" x 2 1/2" x 87") x 8

Hardware (Step 53)
N1 - 1 1/2" Finishing Nails
x 64 total

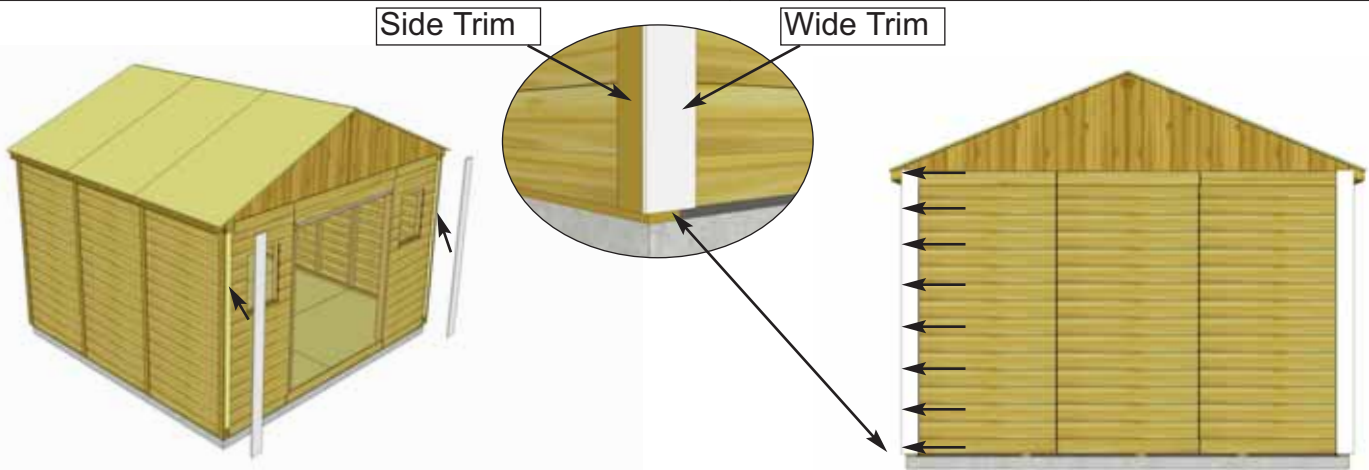

54. Attach **Wide Corner Trims** over **Filler Trims**. Wide Trim will cap Side Trims. Attach with **8 - 1 1/2" Finishing Nails** per piece.

Parts (Step 54)
Wide Corner Trims
(1/2" x 5 1/2" x 90") x 4

Hardware (Step 54)
N1 - 1 1/2" Finishing Nails
x 32 total

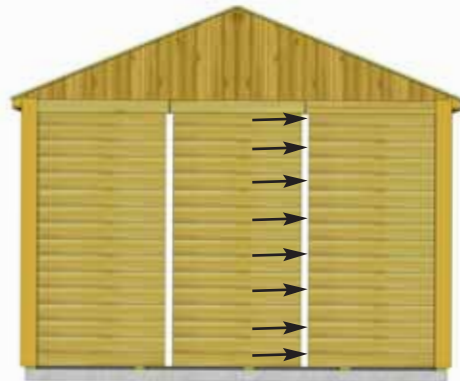

55. Attach **Rear Wall Trims**. to rear of shed. Use **8 - 1 1/2" Finishing Nails** per piece.

Parts (Step 55)
Rear Wall Trims
(1/2" x 2 1/2" x 85") x 2

Hardware (Step 55)
N1 - 1 1/2" Finishing Nails
x 16 total



56. Attach **Vertical Door Trim** on both sides of the doorway. Position flush with **Door Jamb** and tight underneath **Horizontal Gable Trim** . Secure each piece with **8 - 1 1/2" Finishing Nails** per piece.

Parts (Step 56)
Vertical Door Trims
 (1/2" x 3 1/2" x 85") x 2

Hardware (Step 56)
N1 - 1 1/2" Finishing Nails
 x 16 total



57. Attach **Facia Cleat** to underside of **Battens**, flush edge to edge. Repeat this step on rear of shed. Fasten each cleat with **3 - 1 1/4" screws** per piece.

Parts (Step 57)
Facia Cleat
 (3/4" x 1 1/2" x 40") x 8

Hardware (Step 57)
S2 - 1 1/4" Screws
 x 24 total

Expert Advice: Do a dry run by lining up Front, Rear and Side Facia to confirm positioning prior to attaching



58. Attach **Front and Rear Facia (angle cut on ends)**, to **Facia Cleats** on front side, with **10 - 1 1/2" Finishing Nails** per piece. Line up Facia so Facia ends line up with **Rafter** ends.

Parts (Step 58, 60)
F&R Facia (angled ends)
 (3/4" x 5 1/2" x 81 1/4") x 4

Hardware (Step 58, 60)
N1 - 1 1/2" Finishing Nails
 x 40 total



59. Attach **Side Fascia** to roof **Rafter** ends. There are 2 **Side Fascia** pieces per side. Secure with **8 - 1 1/2" Finishing Nails** per piece. **Side Fascia** will cap **Front and Rear Fascia**.

Parts (Step 59, 61)
Side Fascia
 (3/4" x 5 1/2" x 71 1/4") x 4

Hardware (Step 59, 61)
N1 - 1 1/2" Finishing Nails
 x 32 total



60. Attach remaining **Front & Rear Fascia** pieces to **Fascia Cleats** under Roof **Battens** with **10 - 1 1/2" Finishing Nails**. Once again, line up **Fascia** so it is aligned with **Rafter** ends. Do a dry run with **Front, Rear and Side Fascia** to confirm positioning prior to attaching.



61. Attach remaining **Side Fascia** to roof **Rafter** ends as per **Step 59**.

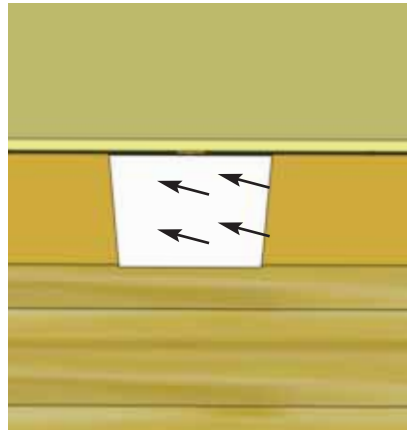

62. Attach **Facia Detail Plates** and **Pentagon Detail Plates** to cover seams where **Facia** and **Trim** pieces come together. Secure each with **4 - 1 1/2" Finishing Nails**.

Parts (Step 62)
Pentagon Detail Plates
 (9 1/2" x 7 1/2") x 2
Facia Detail Plates
 (8" x 5 1/2") x 4

Parts (Step 62)
Gable Detail Plates
 (8" x 4 1/2") x 4
Hardware (Step 62)
N1 - 1 1/2" Finishing Nails
 x 36 total

Note: illustration of Hinge may not be accurate.
 The # of screw holes in the hinge may vary from three to four depending on model.

Attach Black Tee Hinges with 3/4" & 2" Black hardware provided

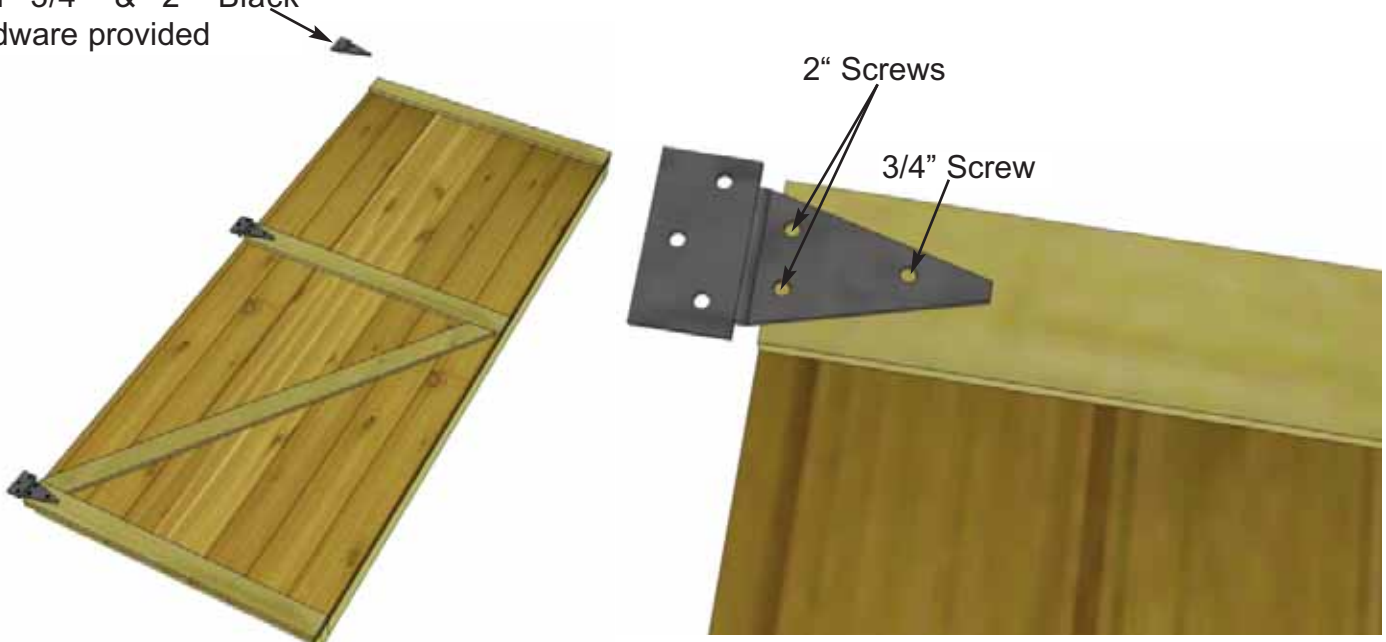

63. Attach Door Hinges to both **Left** and **Right Side Double Doors**. Position Hinges equally on door trim as shown above and attach with Black 3/4" and 2" screws.

Parts (Steps 63 - 65)
Left Side Door
 (31 1/2" x 72") x 1
Right Side Door
 (31 1/2" x 72") x 1

Hardware (Steps 63 - 65)
Y1 - Tee Hinges x 6 total
SB1 - 3/4" Black Screws x 6 total
SB2 - 2" Black Screws x 30 total

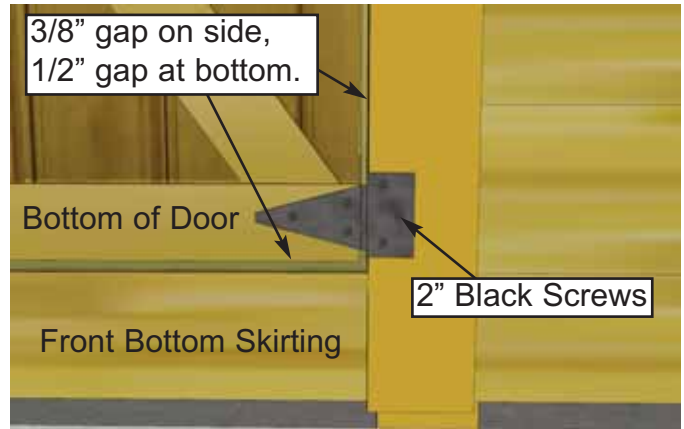

64. Next, position and secure the Double Doors. Starting with **Right Side Door**, position so there is a 1/2" gap on bottom and approximately 3/8" on the side. Use a spare Shingle to shim door in place at the bottom. Secure hinges to Door Trim with **3 - 2" Black Screws** per hinge. **Hint:** Do not attach all the 2" screws until both doors are positioned correctly into place. Use Screw Driver to tighten screws completely.



65. Position **Left Side Door** as per **Step 64** and secure with 2" Black Screws. When satisfied with door positioning, complete all 2" Black Screw attachments. **Note:** Do not over tighten hinge screws when using screw gun. Tighten 3/4 of the way and use a Screw Driver to finish so as not to strip screws.

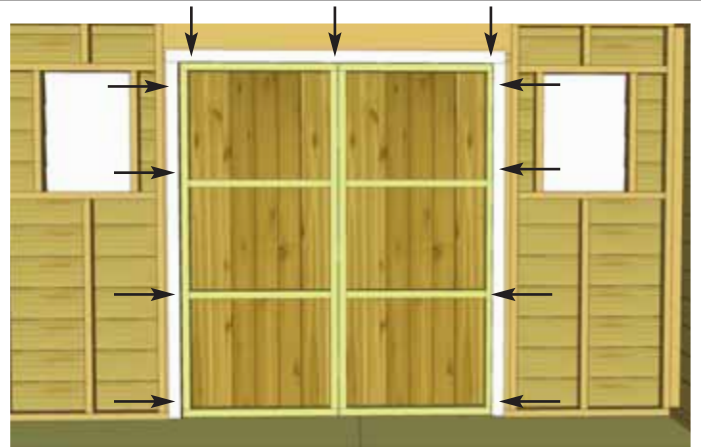

66. Attach **Horizontal** and **Vertical Door Stops** to Door Header and Jambs. Start with Horizontal Stop first and then complete both Vertical Stops. Position so door gap is covered. Use **4 - 2" Screws** per piece to secure.

Parts (Step 66)
Horizontal Door Stop
 (1/2" x 2 1/2" x 68") x 1
Vertical Door Stops
 (1/2" x 2 1/2" x 72") x 2

Hardware (Step 66)
S3 - 2" Screws
 x 12 total

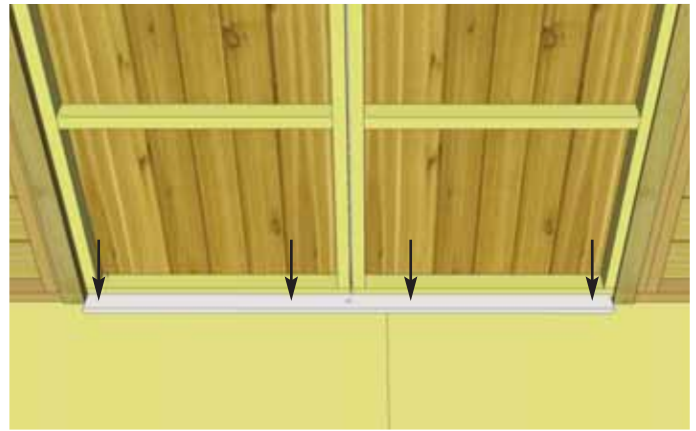
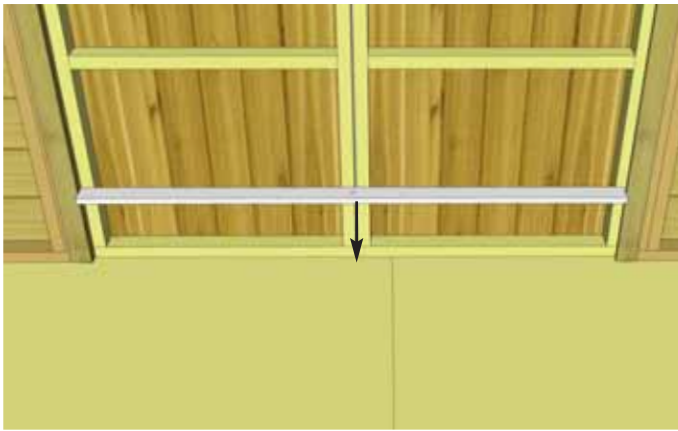

67. Close both doors and align so doors are straight. Attach **Door Threshold** with **4 - 2" Screws**, centering between doorway.

Parts (Step 67)
Door Threshold
 (3/4" x 2 1/2" x 62 1/2") x 1

Hardware (Step 67)
S3 - 2" Screws x 4 total



68. Position and attach **Vertical Door Flange** on inside edge of door frame (**left door from outside**) using **6 - 2" Screws**.

Parts (Step 68)
Interior Door Flange
 (1/2" x 2 1/2" x 71") x 1

Hardware (Step 68)
S3 - 2" Screws
 x 6 total

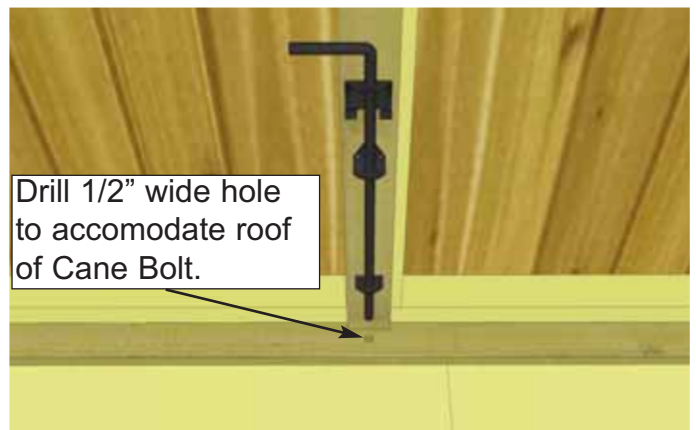

69. The Interior **Cane Bolt** will be attached to Vertical Door Flange. To position Cane Bolt correctly, attach to flange first, close doors and mark hole to house Cane Bolt Rod. Open doors and drill hole where previously marked with 1/2" bit. Attach Cane Bolt with 3/4" black screws.

Hardware (Step 69)
Y6 - Cane Bolt x 1 total
SB1 - 3/4" Black Screws
 x 6 total

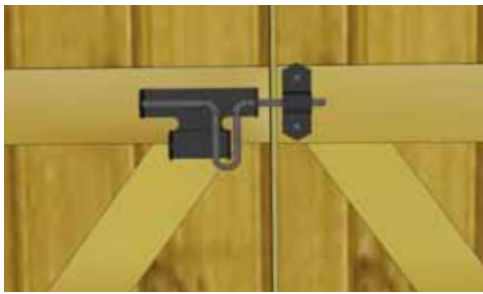

70. Attach **Door Handles** and Exterior Black **Drop Latch** to door. Attach Drop Latch as illustrated above with **5 - 2" Black Screws & 1 - 3/4" Black Screw**. Note how female part of Drop Latch is positioned higher than male. Do a dry run first to position Drop Latch correctly. Attach each Door Handle with **4 - 3/4" Black Screws**, ensure screws connect with inner door stud. **Important:** Drill pilot holes with 1/8" drill bit prior to securing with screws to prevent wood splitting.

Hardware (Step 70)
Y3 - Door Handles x 2 total
Y4 - Drop Latch x 1 total
SB1 - 3/4" Black Screws
 x 9 total
SB2 - 2" Black Screws
 x 5 total

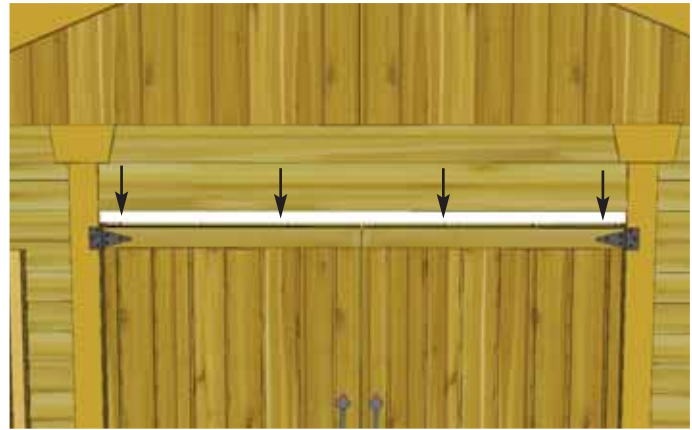
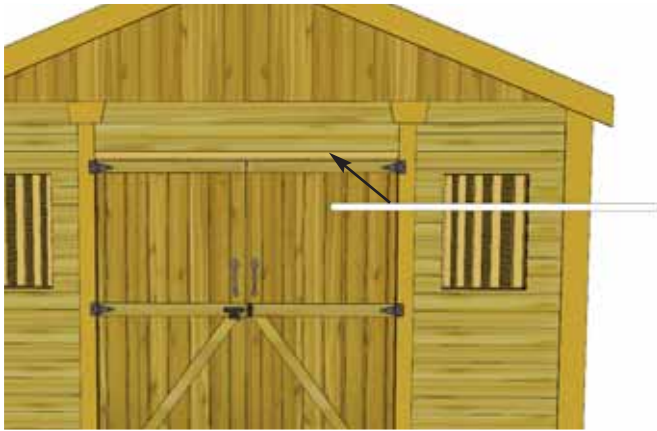

71. Attach **Above Doorway Trim** to the exposed face of **Door Header Riser**, positioning it to be flush to the bottom of **Drip Edge with Bevel Siding attached**. Secure using **4 - 1 1/2" Finishing Nails**.

Parts (Step 71)
Above Doorway Trim
 (1/2" x 1 1/2" x 67") x 1
Hardware (Step 71)
N1 - 1 1/2" Finishing Nails
 x 4 total



72. Locate **Window Inserts**. Before installing, dab caulk in siding channel on both sides and across top of window opening. This will prevent water from getting in behind window. Position window in cavity and secure with **8 - 1 1/4" screws**. **Window trims** will be installed next to hide caulking.

Parts (Step 72)
Regular Window Inserts
 x 2
Hardware (Step 72)
S2 - 1 1/4" Screws
 x 16 total

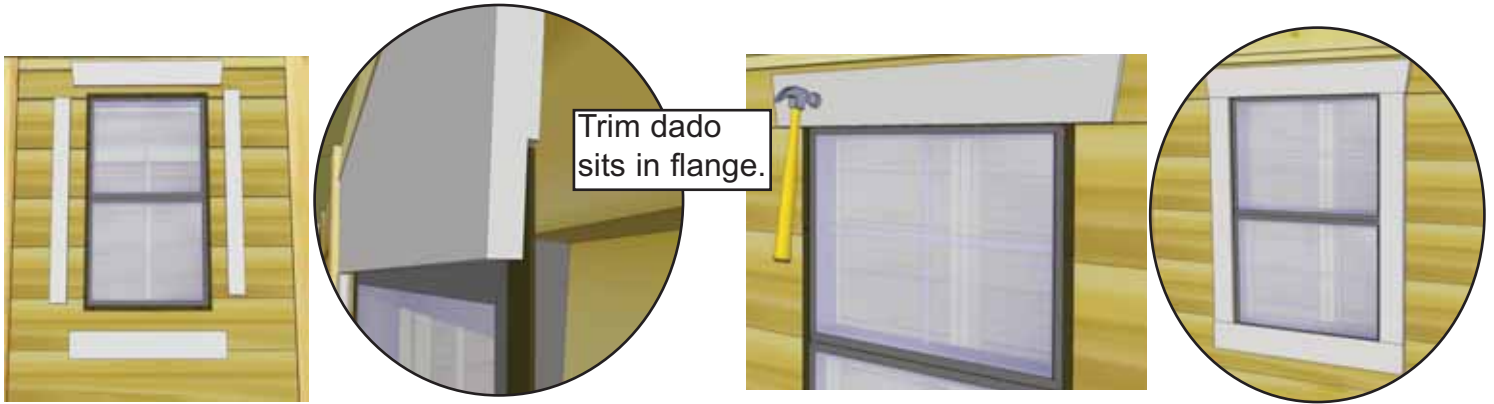

Trim dado sits in flange.

73. Position **Window Trim** around window doing a dry run first and attach with **4 - 1 1/2" Finishing Nails** per piece. The regular window kit is 1" x 24 1/16" = top (angle cut on ends), 3" x 23" = Sides and Bottom. Window trim has a small dado on reverse face. Outside flange of window will roughly sit in the dado to give a better fit.

Hardware (Step 73)
N1 - 1 1/2" Finishing Nails
 x 32 total

Parts (Step 73)
Regular Window Trim
 x 2



74. Assemble **Flower Box Kits** with Assembly Instructions included on Page 46. Position completed Flower Box below bottom of window trim and secure with **2 - 2 1/2" screws**. Screw from inside of box into the center wall stud. Attach second screw 2" underneath first screw and once again into the wall stud. Install Flower Box Kits underneath each window.

Hardware (Step 74)
S1 - 2 1/2" Screws
 x 4 total

Parts (Step 74)
Flower Box Kits
 x 2

Congratulations on completing your new 12 x 12 Spacemaker Garden Shed!

Outdoor Living Today Flower Box Assembly Instructions

Parts Lists:

A - Base, Rear & Front Box Frames	(3pcs)	3/4" x 5 1/2" x 23"
B - End Cap Frames	(2pcs)	3/4" x 5 1/2" x 7" / 8"
C - Front Trim	(1 pc)	3/4" x 1 1/2" x 26"
D - Side Trims	(2 pc)	3/4" x 1 1/2" x 8 3/4"
E - Brackets	(2 pc)	1 1/2" x 5 1/2" x 5 1/2"
F - 1 1/4" Screws		
G - 1 1/4" Nails		

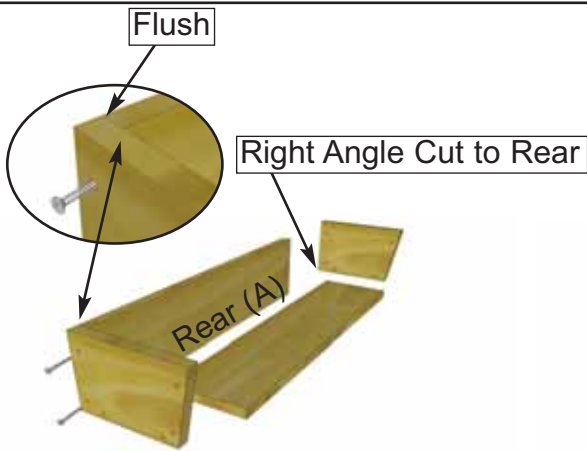
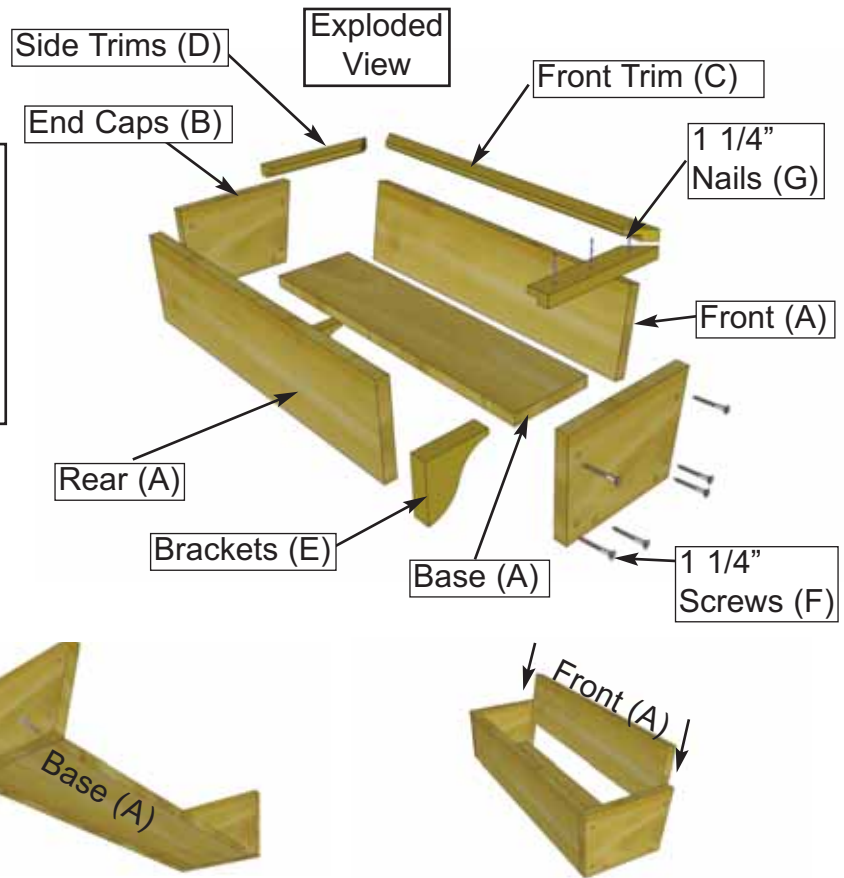

1. On a table position Rear Box and End Cap Frames together so flush at top. Fasten together with 2 - 1 1/4" screws. Place Base Frame tight against Rear and End Cap and flush at bottom. Secure with 2 - 1 1/4" screws. Complete attachment of remaining End Cap Frame. Slide Front Frame between End Caps.

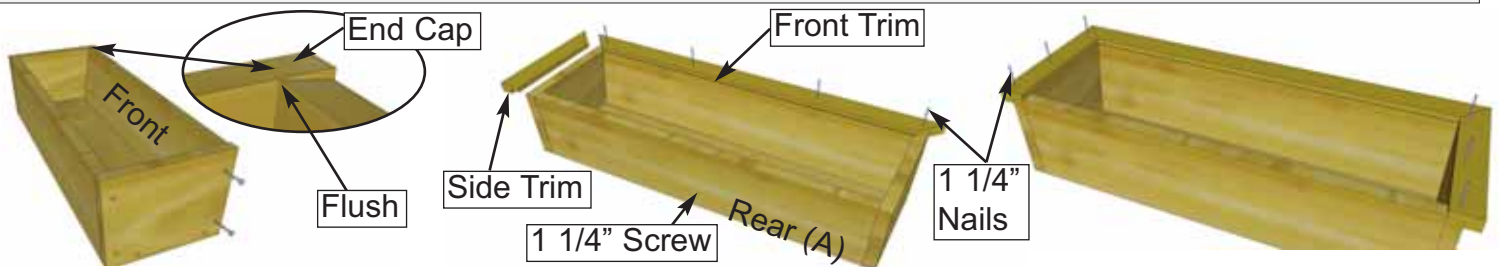

2. Position Front Frame Piece flush with End Cap. Attach both ends with 2 - 1 1/4" screws. Pilot hole Rear Box Frame near bottom center and secure to Base edge with 1 - 1 1/4" screw. Evenly position Front Trim (mitre cut on end and dado cut on inside bottom) tight against front frame and nail down with 4 - 1 1/4" nails. Position Side Trims as per Front and secure with 3 - 1 1/4" nails per side.

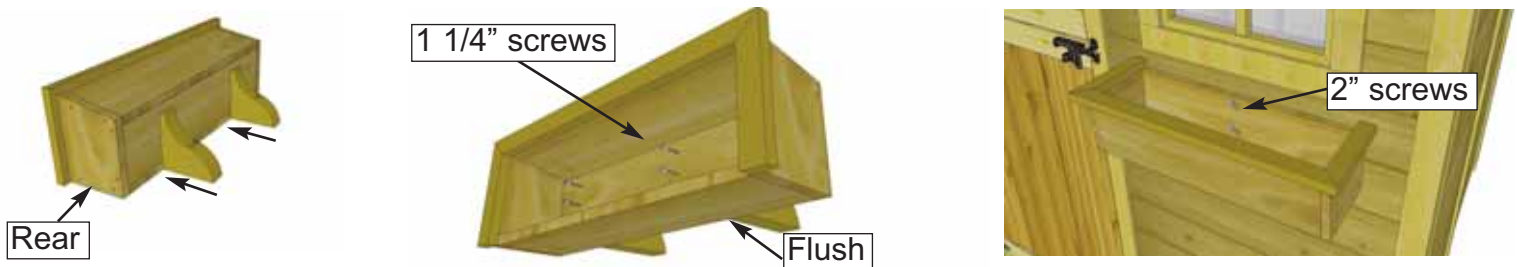

3. On a flat surface, flip Flower Box on it's rear face. Evenly space Brackets and secure through Base Frame and into the Brackets with 2 - 1 1/4" screws per Bracket. Position completed Flower Box beneath window trim and screw from inside of box into the center wall stud with 2 - 2" screws. (2" screws supplied with Base Kit.)

Completed 12x12 SpaceMaker Shed

Note; Our Sheds are shipped as an unfinished product. If exposed to the elements, the western red cedar lumber will weather to a silvery-gray color. If you prefer to keep the cedar lumber looking closer to the original color, we suggest that you treat the wood with a good oil base wood stain. You may also wish to paint your new shed rather than stain it. In both cases we recommend that you consult with a paint and stain dealer in your area for their recommendations.



We hope your experience constructing our building has been both positive and rewarding.

We value your feedback and would like to hear back from you on how well we are doing in the following areas:

1. **Customer Service**
2. **On Time Shipping**
3. **Motor Freight Delivery**
4. **Quality of Materials**
5. **Assembly Manual**
6. **Overall Satisfaction.**



The materials contained in this Assembly Manual may be downloaded or copied provided that ALL copies retain the copyright and any other proprietary notices contained on the materials. No material may be modified, edited or taken out of context such that its use creates a false or misleading statement or impression as to the positions, statements or actions.

Please call, write or email us at:

Outdoor Living Today

Canadian Address
9393 287th Street
Maple Ridge, British Columbia
Canada V2W 1L1

United States Address
P.O. Box 96
Sumas, Washington
USA 98295