

# 6x6 Maximizer Storage Shed Assembly Manual T&G with Metal Roof



Version #1.2  
January 21, 2022



Thank you for purchasing a 6x6 Maximizer Storage Shed. Please take the time to identify all the parts prior to assembly.

## Safety Points and Other Considerations

Our products are built for use based on proper installation and normal residential use, on level ground. Please follow the instruction manual when building your shed and retain the manual for future maintenance purposes.

Some of the safety and usage measures you may wish to consider include:

- snow load ratings vary by geographical location. If heavy or wet snowfall occurs, it is advisable to sweep the snow off the roof(s).
- if the product is elevated, any structural and building code requirements are solely the customer's responsibility, and should be abided by.
- in high or gusty wind conditions it is advisable to keep the structure securely grounded.
- have a regular maintenance plan to ensure screws, doors, windows and parts are tight.

Customer agrees to hold Outdoor Living Today Partnership and any Authorized Dealers free of any liability for improper installation, maintenance and repair.

**In the event of a missing or broken piece, simply call the Outdoor Living Today Customer Support Line @ 1-888-658-1658 within 30 days of the delivery of your purchase. It is our commitment to you to courier replacement parts, free of charge, within 10 business days of this notification. Replacement parts will not be provided free of charge after the 30 day grace period.**

# What to do before my Shed arrives?



- Become familiar with this assembly manual and determine if you can complete the project yourself or will require a professional contractor.



- One helper is recommended to assist in constructing your shed. It generally takes two people over two days to assemble a shed. If you're hiring a contractor, their rate should be in line with that duration of work.



- Clear the construction area and ensure a clear pathway for delivery when the freight company arrives. Remove all debris: roots, grass, rocks, etc.



- Excavate the site. Contact your local utilities company to ensure there are no gas or electric lines buried in the area before digging.

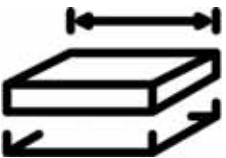

- Decide on the type of foundation you will be using:
  - Concrete slab, or
  - 4-6 inches of crushed gravel with paver stones or 4x4 stringers.

You can find the footprint for your shed on Page 3 of your Assembly Manual.



- If doing the assembly yourself, have all the necessary tools ready to go and in working condition. A list of required tools can be found after the parts list.

# Foundation Types for 6x6 Garden Shed

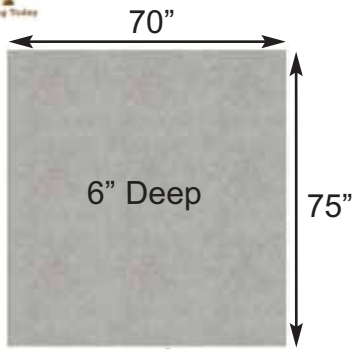

Front Side

**Concrete Foundation**

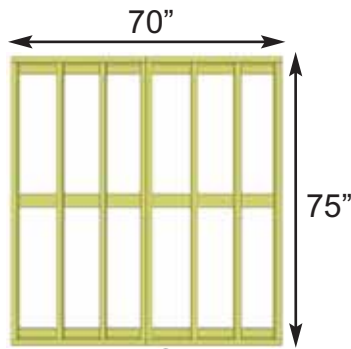

Front Side

**Floor Frame**



Front Side

**Completed Foundation**

**Concrete Slab Foundation:**

- Slab must be at least the same size as assembled floor frame (70" x 75") or larger.
- 6" Deep foundation.
- 0.7 Cubic Yards of concrete required.
- A concrete slab will have the longest durability out of your foundation options.

**Once level, a concrete slab is the easiest surface to build on.**

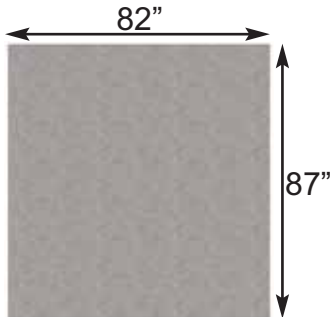

Front Side

**Gravel Foundation**

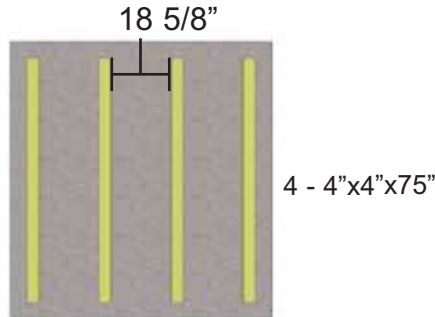

Front Side

**Gravel Foundation with treated stringers**



Front Side

**Completed Foundation**

**Gravel with 4x4 Pressure Treated Stringers:**

- Excavate at least 6" deep, and 6" wider than floor frame on each side.
- 1.0 Cubic Yards of gravel required, approximately 9 wheelbarrows.
- 4 - 4x4 Pressure Treated Stringers 75" long required.
- Evenly spaced, with one at each end of floor frame.

**Saves money on materials, easy to level and work with.**

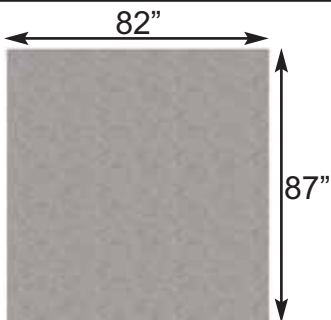

Front Side

**Gravel Foundation**



Front Side

**Gravel Foundation with Patio Pavers**



Front Side

**Completed Foundation**

**Gravel with Patio Paver Stones:**

- Excavate at least 6" deep, and 6" wider than floor frame on each side.
- 1.0 Cubic Yards of gravel required, approximately 9 wheelbarrows.
- 12 patio pavers (8" x 8" or larger).
- Center patio paver stones underneath floor runners and underneath seams in floor joists.

**Patio paver stones are widely available from most landscape stores.**

**Thank you for purchasing a 6x6 Maximizer Storage Shed**  
**Please take the time to identify all the parts prior to assembly.**

## **Parts List:**

### **A. Floor Section - Steps 1 - 11**

- 2 - 35" x 75" - Floor Joist Frames
- 2 - 5/8" x 34 7/8" x 74 7/8" - Plywood Floor
- 4 - 1 1/2" x 3 1/2" x 72" - Floor Joists
- 3 - 1 1/2" x 3 1/2" x 70" Floor Runners

### **B. Wall Section - Steps 12 - 30**

- 6 - 35" x 75" - Wall Panels - (Walls with Bottom Plates Unattached)
- 6 - 1 1/2" x 2 1/2" x 35" - Bottom Wall Plates

#### **Door Jambs & Header**

- 2 - 2 1/2" x 3 5/8" x 73" - Vertical Door Jamb
- 1 - 2" x 2 1/2" x 71 1/4" - Door Header
- 1 - Left Side Door
- 1 - Right Side Door
- 1 - 2 1/2" x 1 1/2" x 64" - Horizontal Door Stop with Dado cut
- 1 - 2 1/2" x 3/4" x 62 1/2" - Door Threshold
- 1 - 1/2" x 2 1/2" x 71" - Interior Door Flange
- 2 - 1/2" x 2 1/2" x 71" - Door Stops

#### **Gable Walls**

- 2 - Gable Walls - Triangular Shaped

#### **Top Wall Plates**

- 2 - 3/4" x 2 1/4" x 65" - Front & Rear Top Plates  
( Angle cut on 1 edge)
- 2 - 3/4" x 2 1/2" x 75" - Side Top Plates (Angle cut on ends)
- 2 - 1 1/2" x 5 1/2" x 5 1/2" Front Triangular Corner Brackets

### **C. Rafter and Roof Section - Steps 31 - 55**

#### **Rafters**

- 12 - 1 1/2" x 3 1/2" x 45" - Roof Rafters with angled ends
- 4 - 3/4" x 1 1/2" x 42" - Facia Nailing Strips
- 2 - 3/4" x 4 1/2" x 70" - Roof Ridge Boards
- 2 - 1/2" x 4 1/2" x 70" - Soffits
- 1 - 3/4" x 3 1/2" x 48" - Gusset

#### **Roof**

- 12 - 3/4" x 3 1/2" x 39" - Roof Battens
- 8 - 3/4" x 1 1/2" x 17 1/8" - Batten Spacers
- 6 - 50" long x 39" wide - Metal Roof Panels
- 2 - 13" wide x 60" long - Metal Ridge Caps

### **D. Miscellaneous Section - Steps 56 - 77**

#### **Bottom Skirting**

- 6 - 1/2" x 4 1/2" x 34 3/4" - Side and Rear Bottom Skirting
- 1 - 3/4" x 4 1/2" x 64" - Front Bottom Skirting

#### **Corner & Sidewall Trim**

- 2 - 5/8" x 2 1/2" x 75" - Rear Filler Trim
- 2 - 3/4" x 4 1/8" x 79" - Front Wide Trim
- 2 - 1/2" x 4 1/2" x 77 1/2" - Side Front Wide Trim
- 2 - 1/2" x 4 1/2" x 77 1/2" - Side Rear Wide Trim
- 4 - 1/2" x 4 1/2" x 37 7/8" - Horizontal Gable Trim
- 3 - 1/2" x 2 1/2" x 79" - Narrow Trim (Rear Wall)
- 2 - 1/2" x 2 1/2" x 77 1/2" - Narrow Trim (Side Walls)
- 1 - 1/2" x 1 1/4" x 64" - Above Door Trim

#### **Facia Trim**

- 2 - 3/4" x 3 1/2" x 79 1/2" - Front and Rear Facia
- 4 - 3/4" x 3 1/2" x 46" - Side Facia - Angle cut both ends - ( 2 right / 2 left)

#### **\*\*Miscellaneous Pieces**

- 2 - Pentagon Facia Plate
- 2 - Horizontal Gable Detail Plates (See Step 54)
- 1 pc - Spare Wall Siding
- 2 pc - Cedar Shingles used for Shims
- Several Pcs - Foam Enclosures for Metal Roof

# 6 x 6 MAXIMIZER - METAL ROOF - HARDWARE PACKAGE

## Screws and Nails

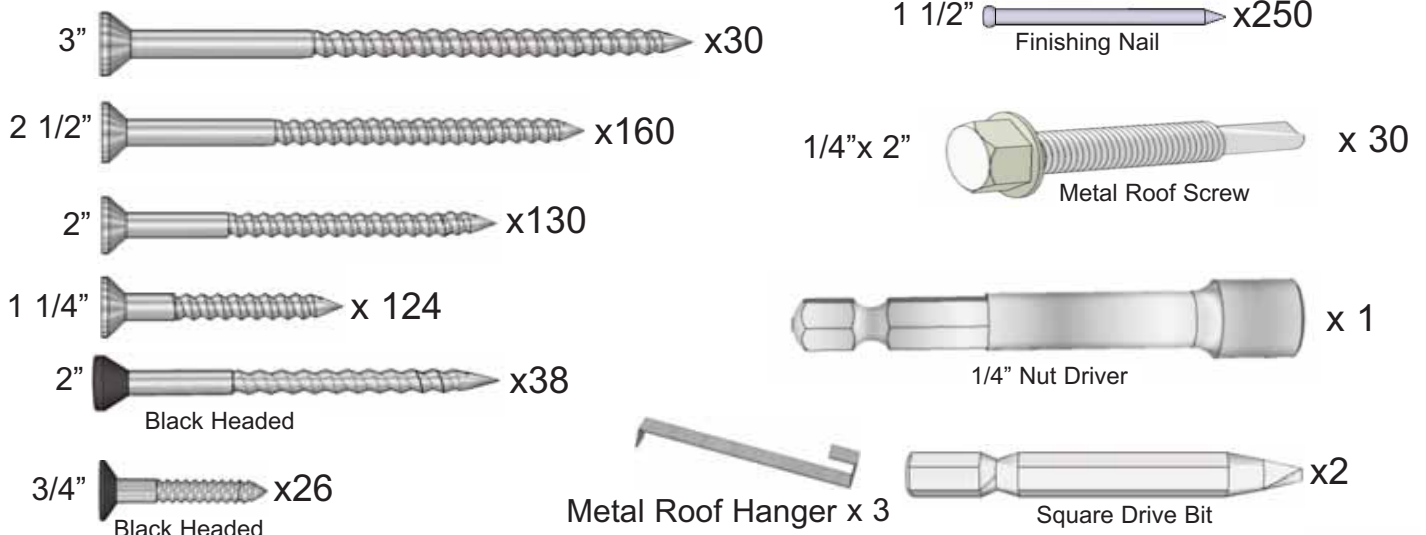

## Individual Hardware Components (not actual size)

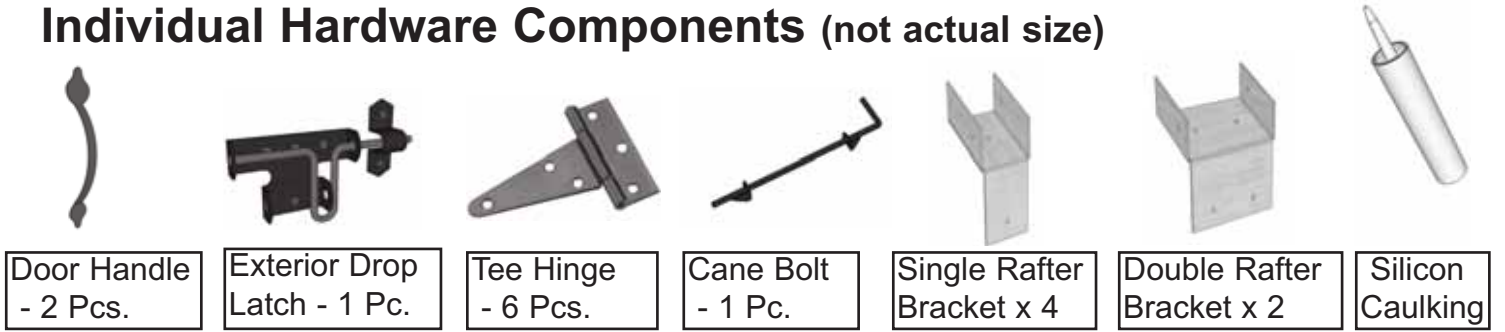

## Tools Required (not provided)



## Safety Equipment Required



## Before/During Assembly:

- 1.) Paint each face and edge of your plywood floor with a latex exterior paint.
- 2.) Caulk wall seams if gaps appear.
- 3.) Caulk around window framing.
- 4.) Caulk perimeter between floor plywood and bottom wall plate.
- 5.) Caulk channels in lap siding at the top of your door above the trim, just a drop in each channel.
- 6.) Caulk edge of door threshold (if applicable).
- 7.) Optional: Install a Sill Gasket between floor runners and foundation.
- 8.) Optional: Install an 8" strip of roofing paper below Cedar Ridge Caps for Cedar Roof Sheds.

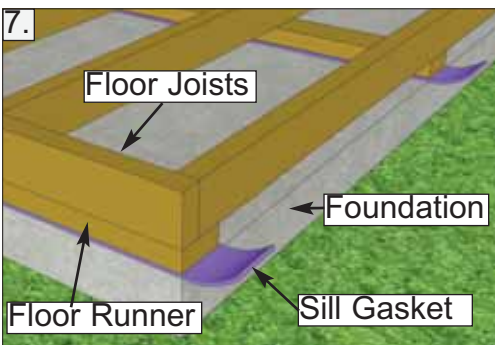
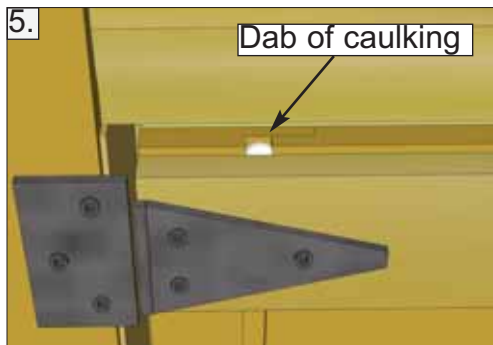
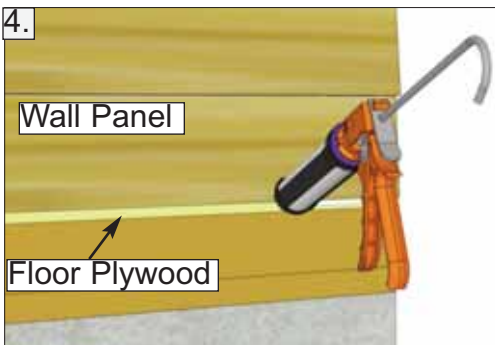
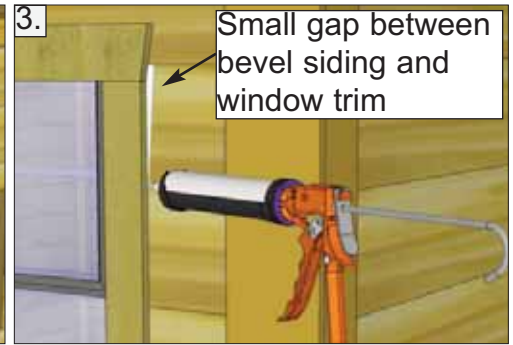
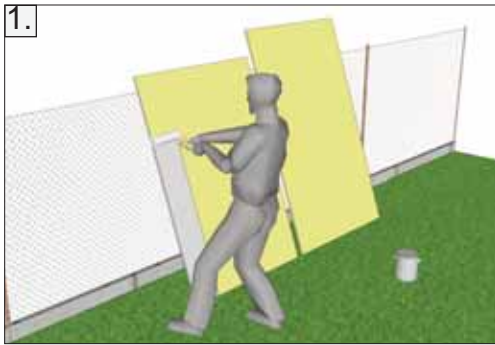

## Routine Maintenance:

- Routinely check all fasteners are tight (ex. Door Hinges, Nails)
- Brush off dirt from walls.
- Brush off snow from roof regularly.
- Routinely remove needles and leaves from roof.

## Painting/Staining

- Your cedar shed, if left untreated, will weather to a silvery grey colour.
- Painting or staining your structure is highly recommended and will prolong the life of your shed.
- You do not need to wait to paint or stain your shed, the wood in your kit has been dried and can be stained or painted immediately.
- Consult your local paint store for the best paint or stain for cedar.
- Optional: stain the inside of your shed. (Note: this will remove the fresh cedar smell.)

# A. Floor Section

Exploded view of all parts necessary to complete Floor Section. Identify all parts prior to starting.

Note, Floor Footprint is 70" wide x 75" deep.

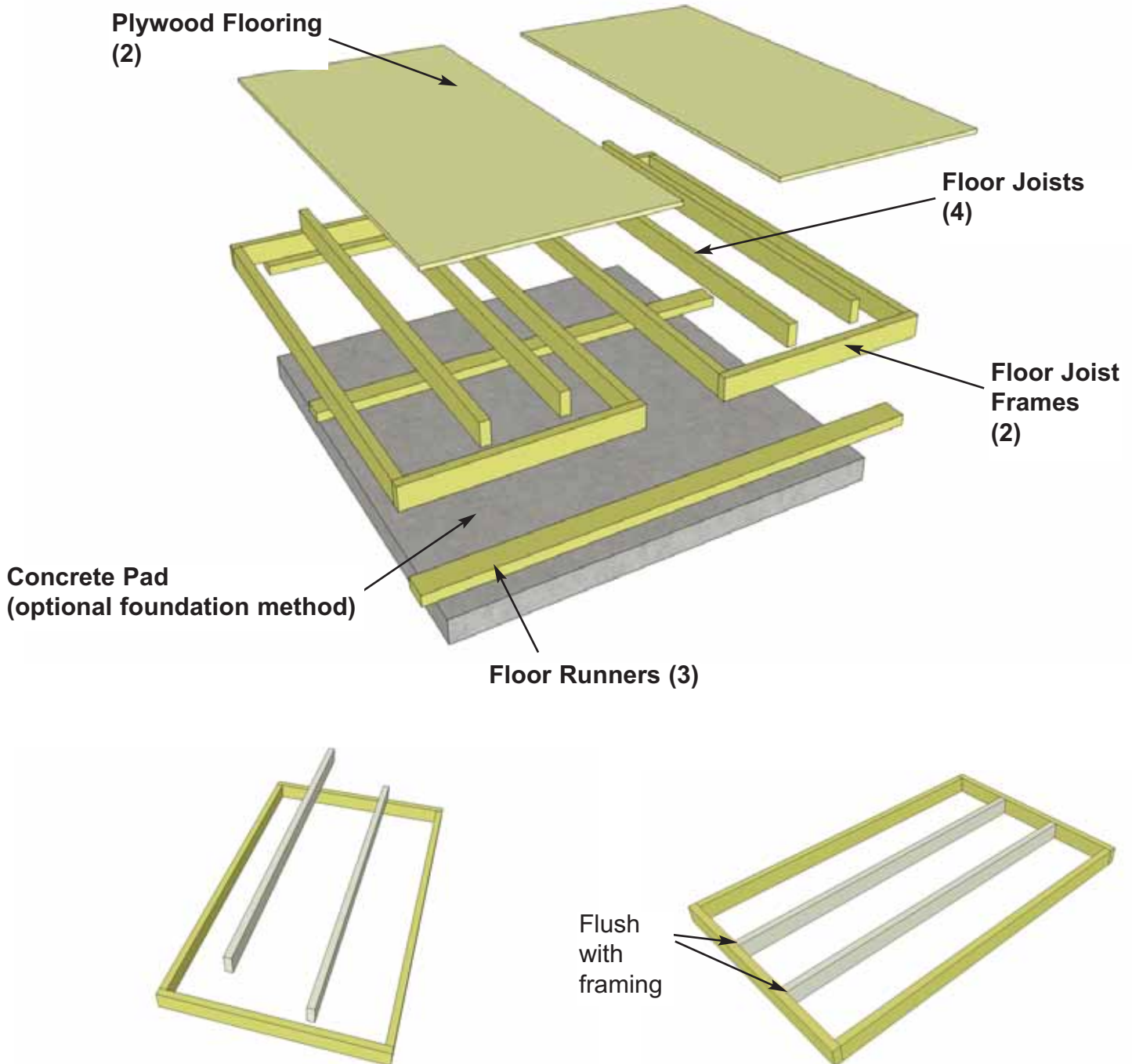

- 1.** Lay out one **Floor Joist Frame** and **2 Floor Joists** as illustrated above. Position Joists equally in Floor Joist Frame. Position Joist so flush with framing.

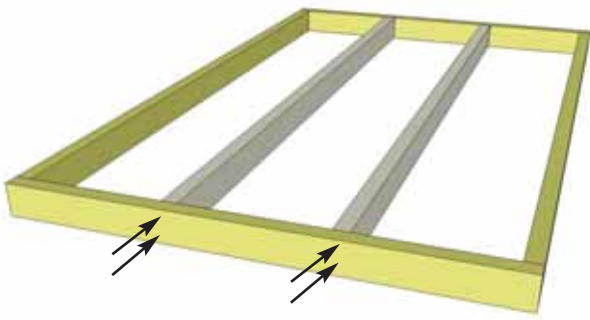

You can find the Square Drive Bit for the screws in with the Hardware Kit Bag.

**2.** When correctly positioned, attach each Joist with 4 - 2 1/2" screws (2 per end). Complete Joist attachments for 2nd Floor Frame.

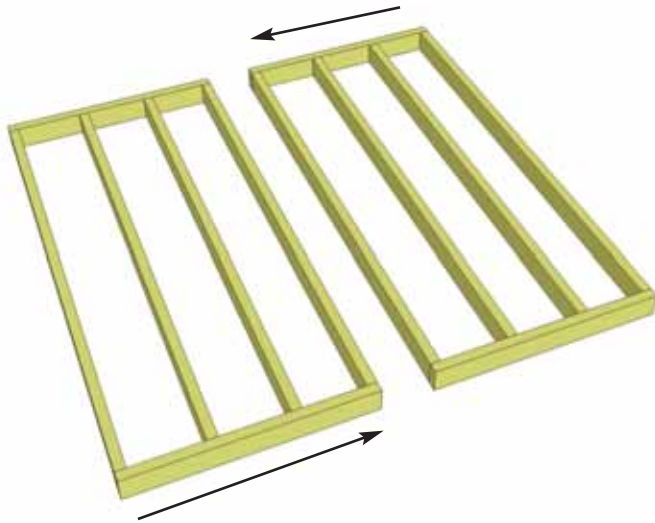

**3.** Lay out both completed **Floor Joist Frames** as illustrated at left.

**4.** Align Floor Joist Frames together as shown below. Screw Sections together with 8 - 2 1/2" screws.

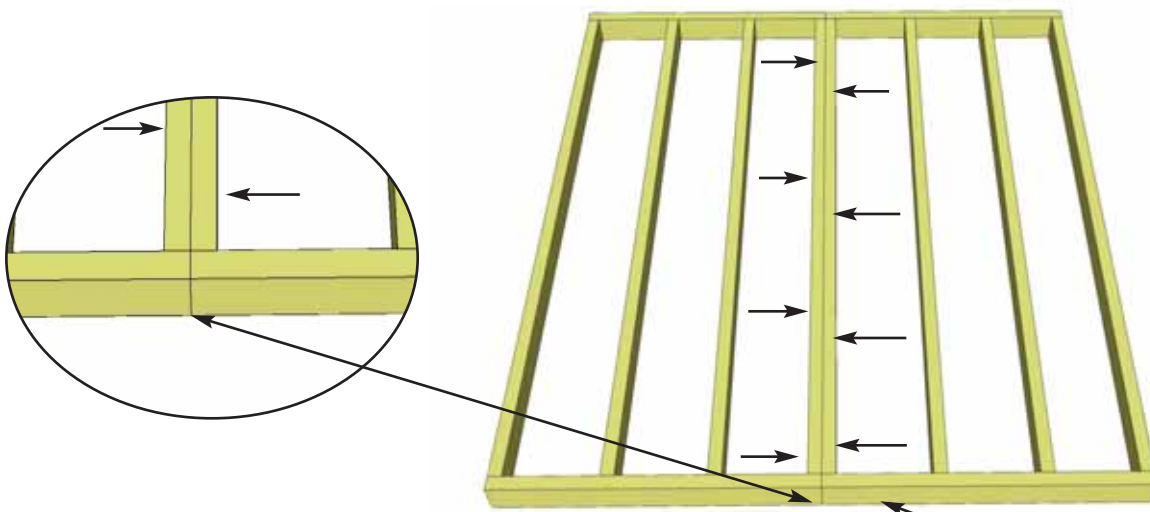

**5.** When completed, your floor footprint should be 70" wide x 75" deep.

Door goes on 70" side



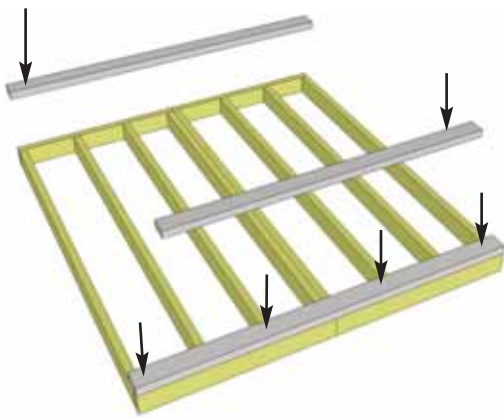

**6.** Attach **Floor Runners** to completed floor frame. There are 3 floor runners per 70" side. Use 8 - 2 1/2" screws per Runner.

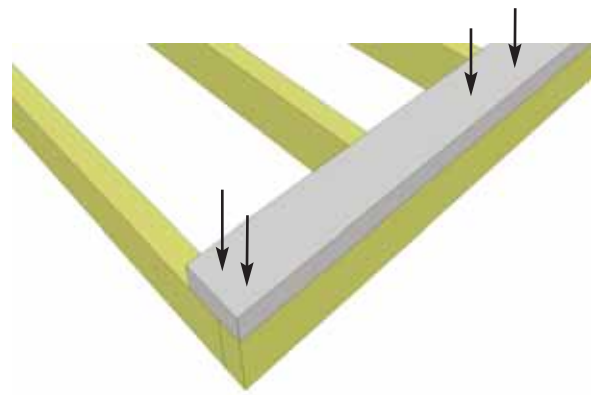

**7.** Make sure Runners are flush with outside and front and rear floor framing but not overhanging.

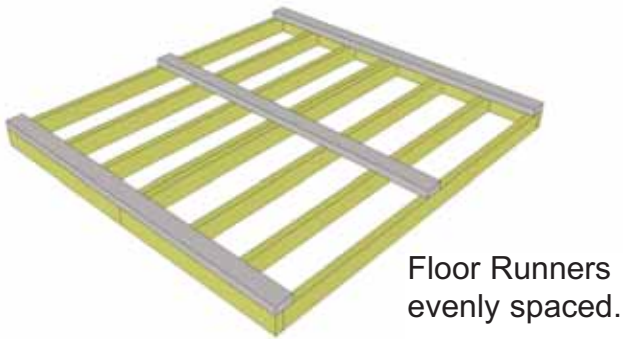

**8.** Complete all Floor Runners.

### Foundations

**Note:** The floor will be flipped over and floor runners will sit on your foundation. It is important to note that having a level foundation is critical. Choosing a foundation will vary between regions. Typical foundations can be concrete pads or patio stones positioned underneath the floor runners.



**9.** With Floor Runners attached, carefully flip the floor over and place on your foundation. **Caution-** you will need 2 people to assist you. Be careful when laying floor down not to bend or twist floor. When in place, level floor completely.

**Measure diagonal** in both directions to confirm square. Both should be approximately 102 1/2". Adjust floor if necessary.

**Measure Diagonal**

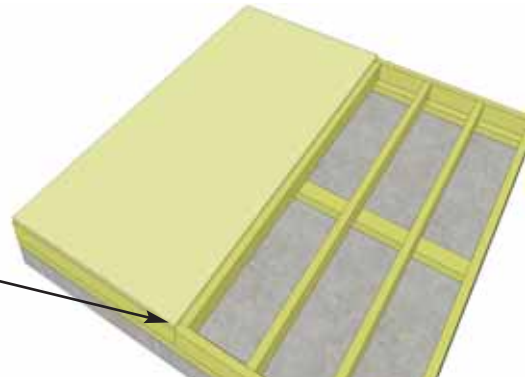
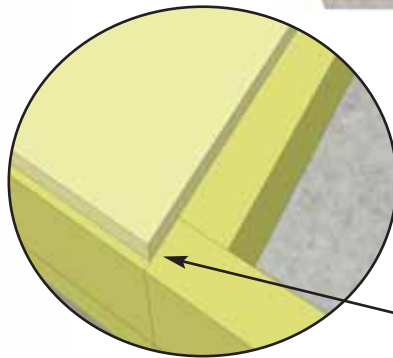
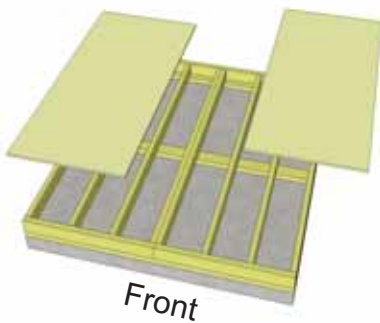
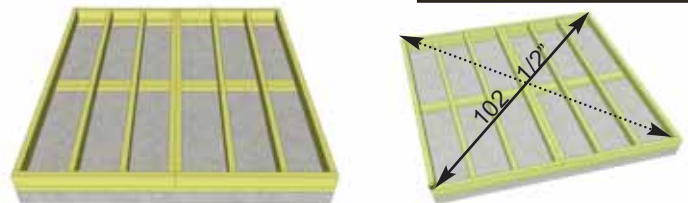

**10.** Position **Plywood Floor** pieces (2) on top of completed floor frames. The Plywood is cut slightly smaller than floor framing. Keep plywood seams tight.

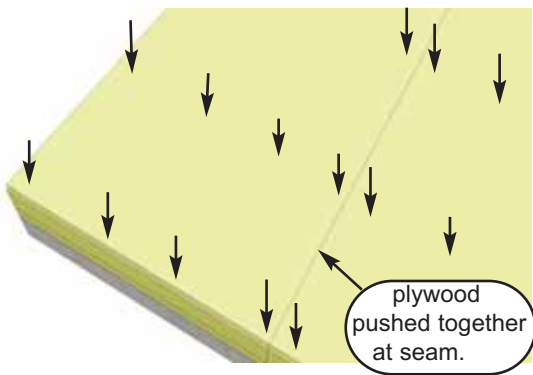

**11.** With Plywood positioned correctly on floor framing, attach using 16 - 1 1/4" screws per sheet.

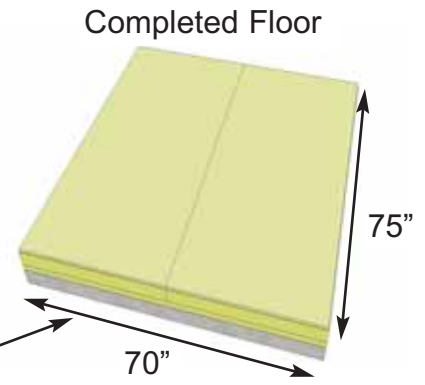

## B. Wall Section

Exploded view of all parts necessary to complete the Wall Section. Identify all parts prior to starting.

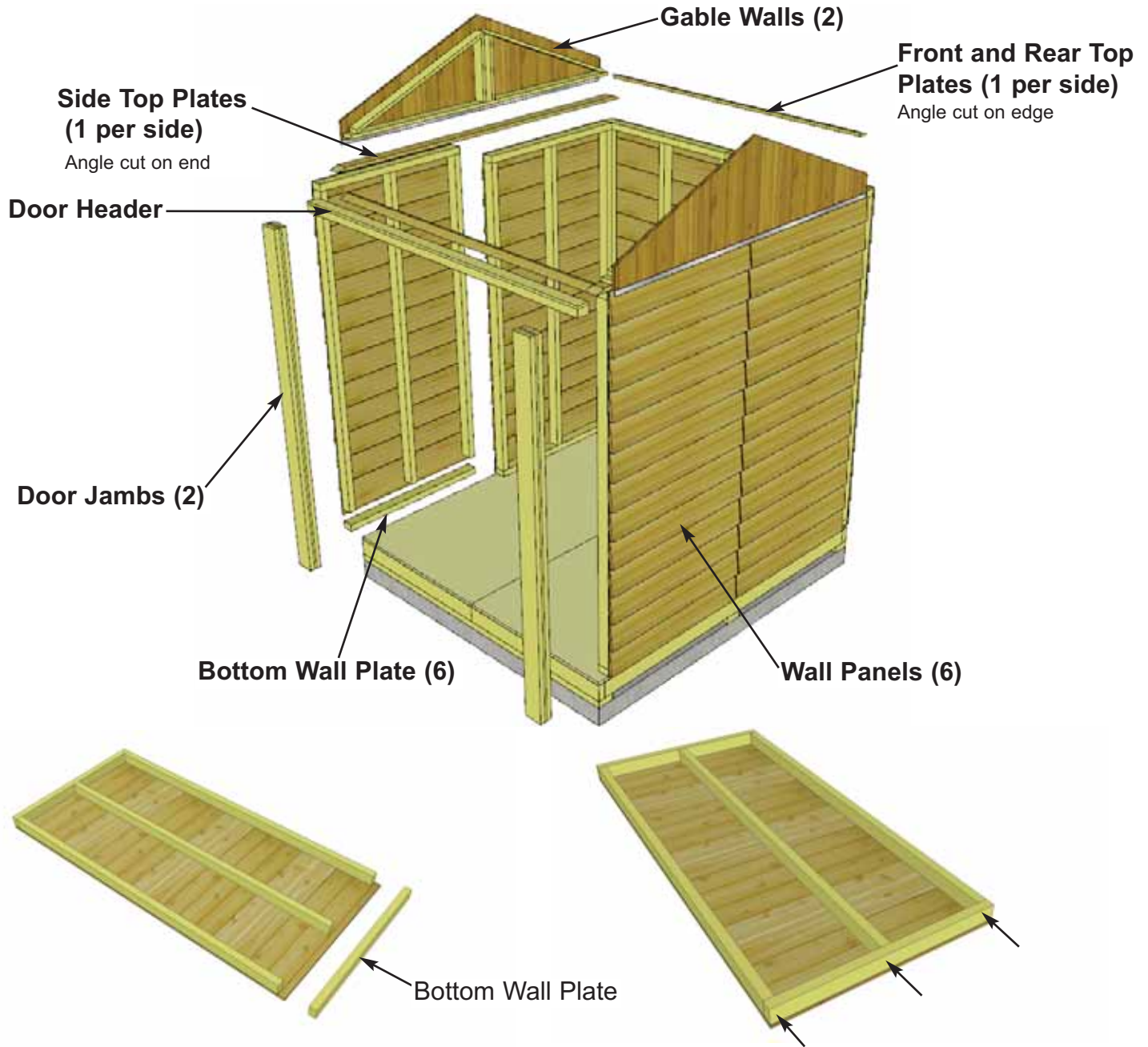

**12.** Starting with **Solid Wall Panels**, carefully lay panel face down. Position and attach **Wall Plate** to bottom of wall studs of each wall panel with 3 - 2 1/2" screws. Position plates flush with framing.

Plywood Floor shown in Floor Section B illustrations may not be exactly as shipped.

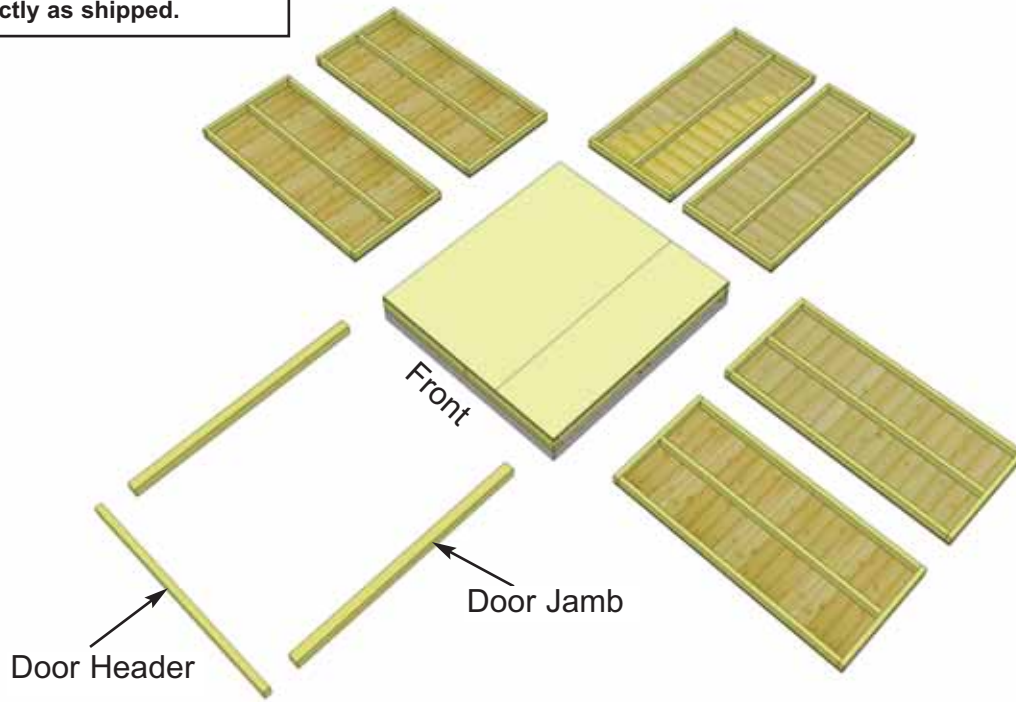

**13.** Lay out all the wall panels and become familiar with their location.

Make sure to position panels right side up so water is directed away from and not into shed.  
Note, to determine correct alignment, the attached Bottom Wall Plate of wall panel will be sitting on floor.

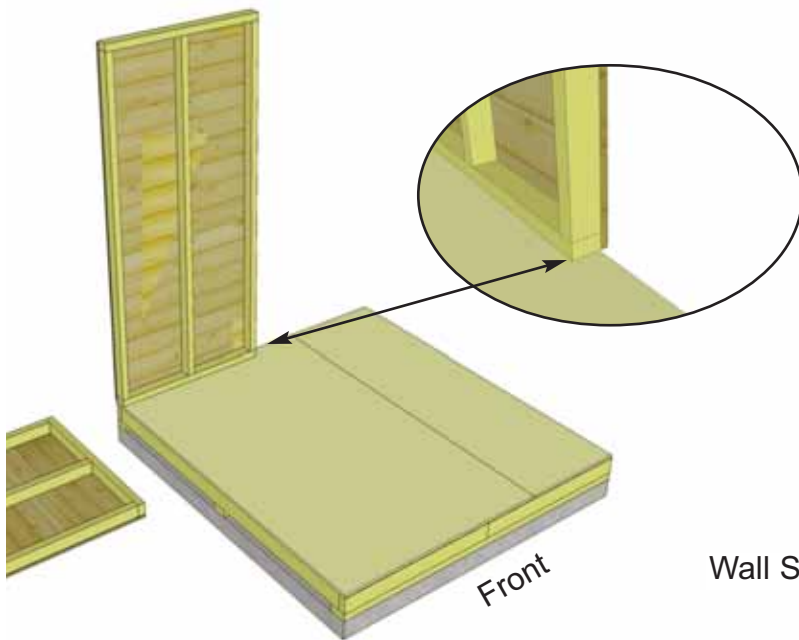

**14.** Starting at Rear Corner, position a Wall Panel on top of plywood floor. The Wall Panel bottom framing will sit flush with Floor Framing. Wall siding will overhang the floor.

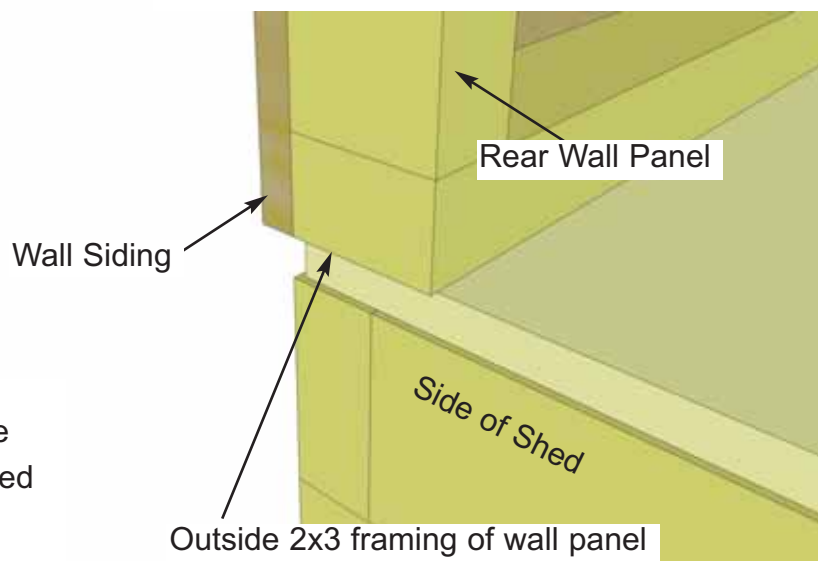

**15.** The wall panel will sit flush at the end of the plywood floor with the side wall panels sandwiched between them.

**Note:** Siding will overhang the floor by approx. 1/2"



**Optional** - Caulking seams will help prevent moisture from entering at seam.  
**Caulking not included in kit.**

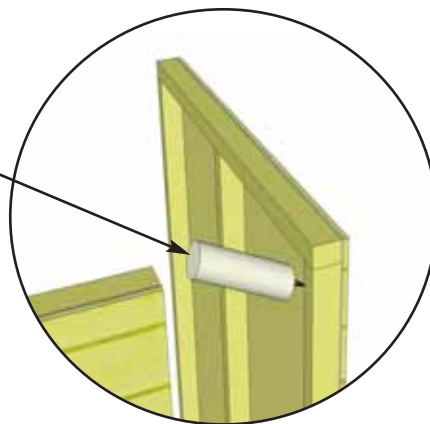

**16.** Position side wall into place on plywood floor. Butt both vertical wall studs of side and rear walls together and attach with 3 - 2 1/2" screws. Screw at the bottom, middle and top of stud to secure properly.

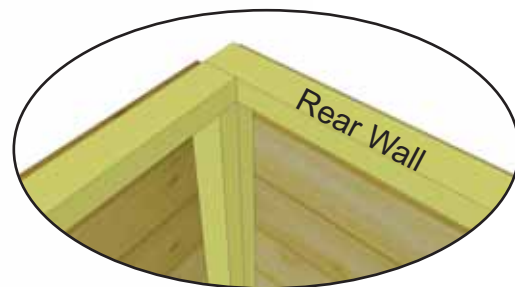

**Do Not Attach Walls To Floor until Step 27.**

**17.** With the corner wall attachment complete, position a second side wall panel in place.

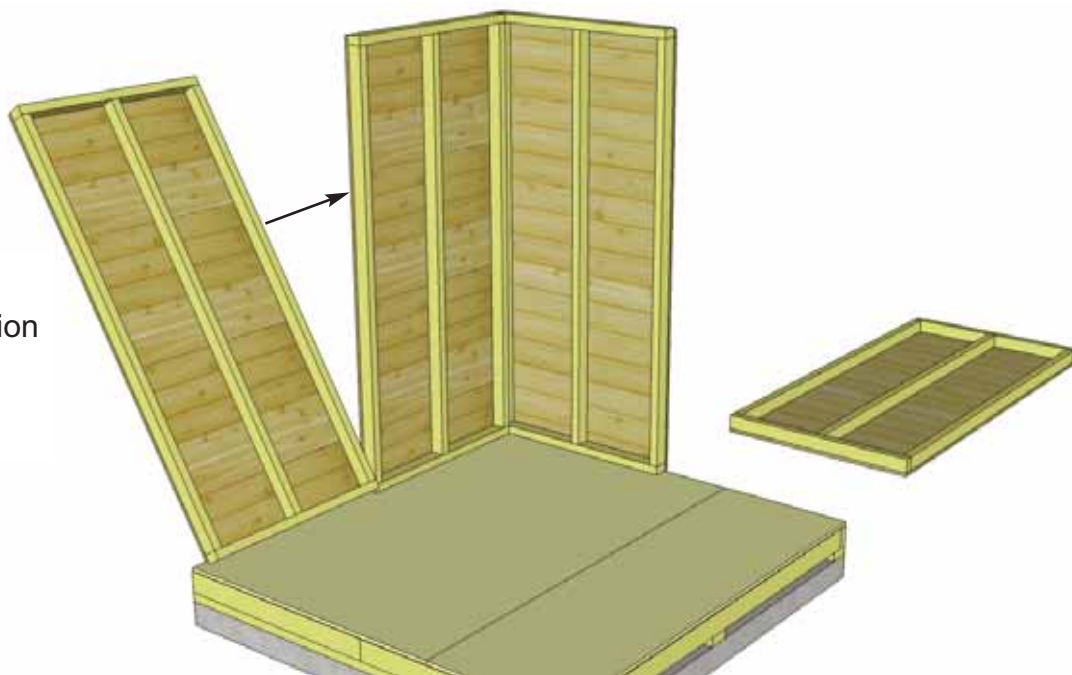



**18.** Align vertical wall studs of both side wall panels together and attach with 3 - 2 1/2" screws. Wall siding should overhang floor by approximately 1/2". Position 2nd rear wall panel as previously described.

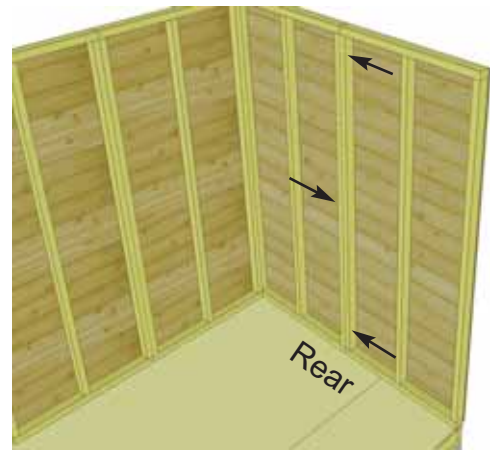
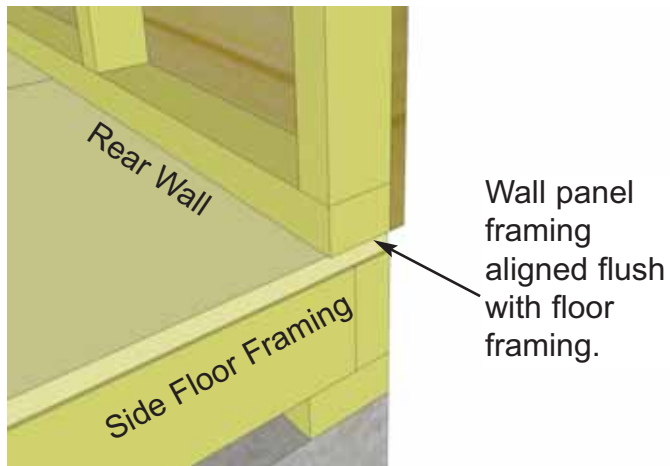

**19.** Align wall panel framing flush with floor framing and attach vertical wall studs together as per **Step 18**.

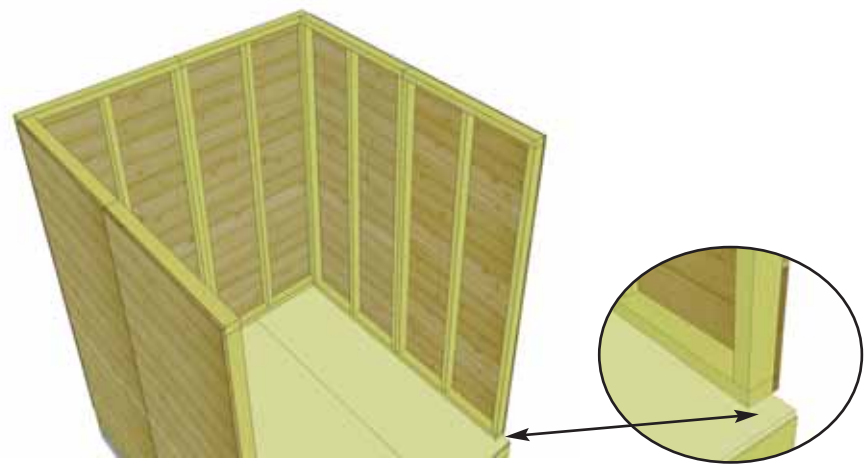
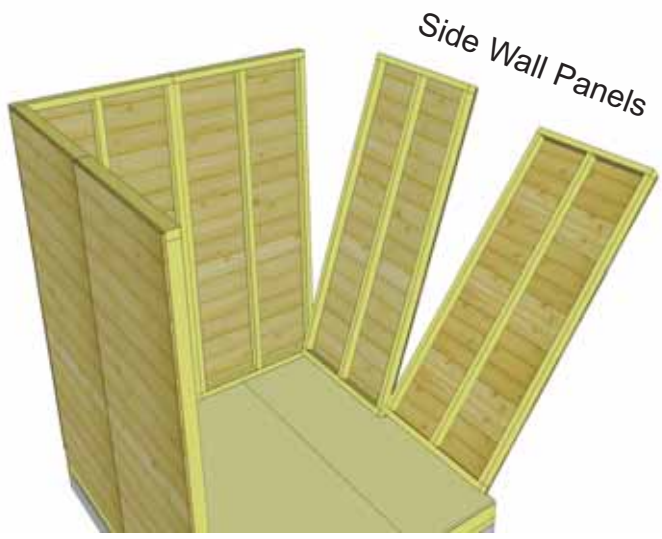

**20.** Position and attach remaining side wall panels together as per **Steps 16-18**.

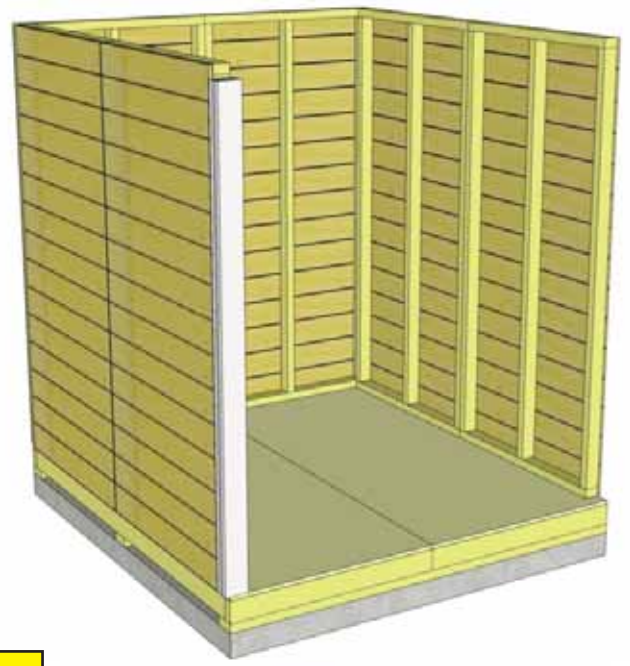
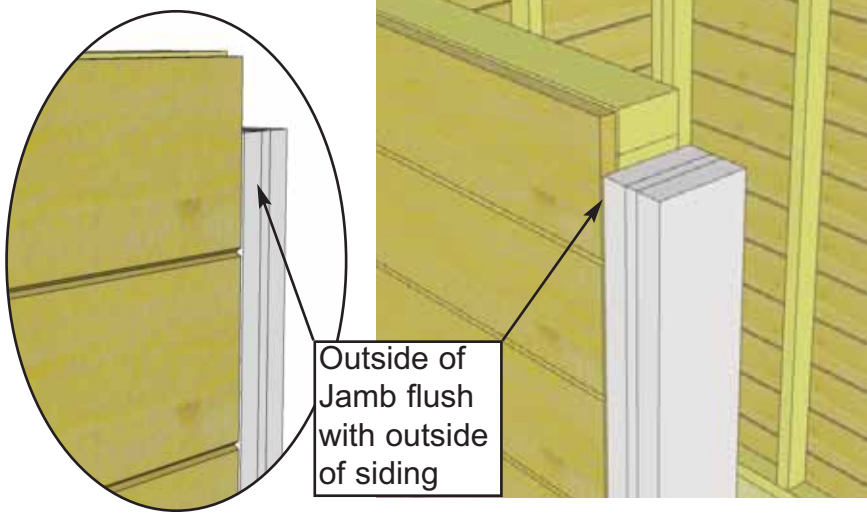

**21.** Locate Door Jambs. Position outside of Jamb flush with outside of siding. At the floor, Jamb should be flush with floor framing on the front and overhanging floor framing on sides.

When aligning Jambs and Header in **Steps 21-23**, do a dry run first to confirm spacing. Tack jambs with only a few screws initially. Jambs should be 64" apart when measured inside to inside.

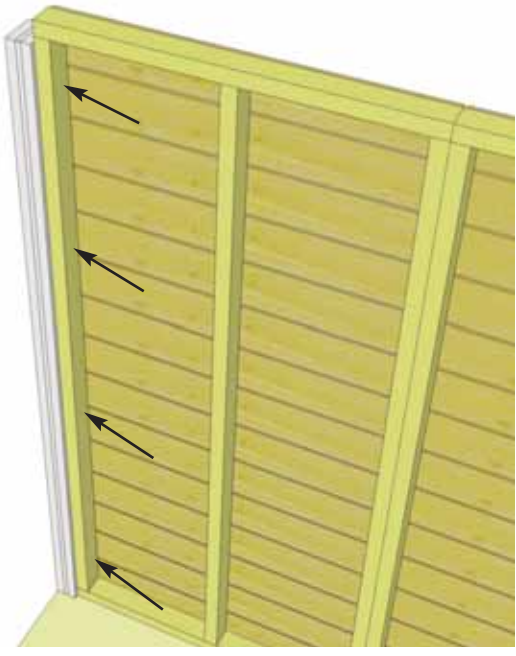
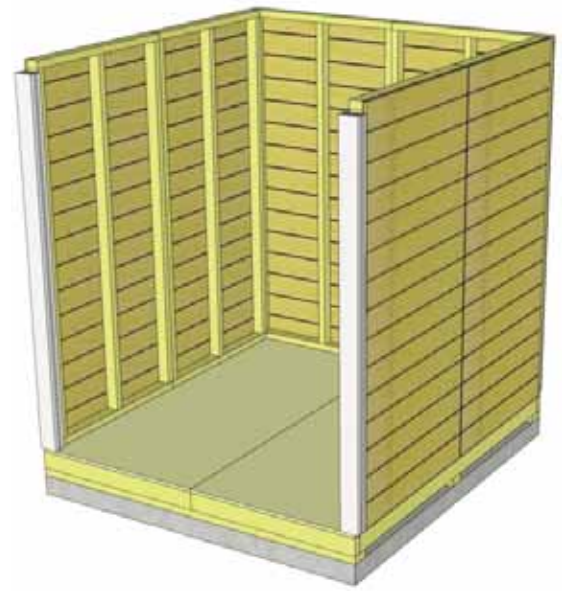

**22.** Attach Door Jamb to vertical wall stud with 4 - 2 1/2" screws. Complete both Door Jambs.

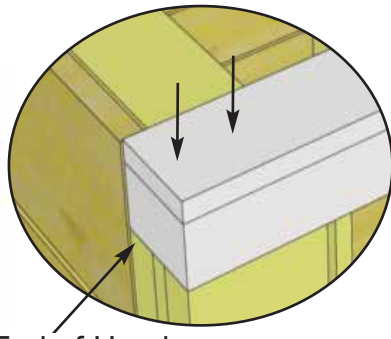
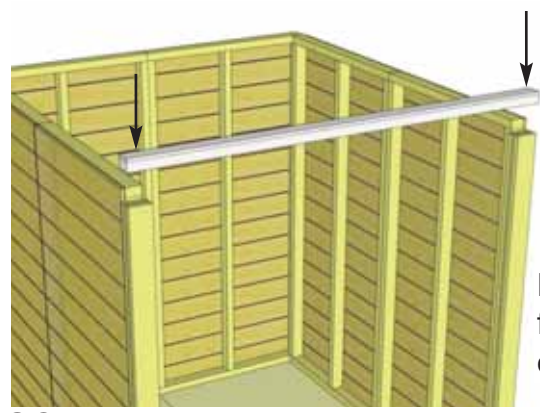

End of Header flush with outside of Door Jamb.



**23.** Position and attach the Door Header flush to outside end of Door Jamb with 2 - 2 1/2" screws per side. Important- Drill 1/8" pilot holes in end of Door Header to prevent wood from splitting.

On ends, screwing on slight angle provides more strength

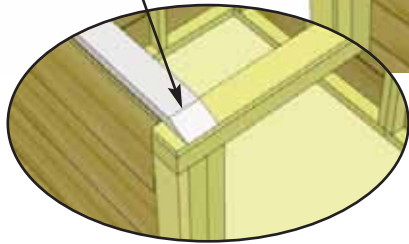

Top Plate aligned flush with inside of wall framing.

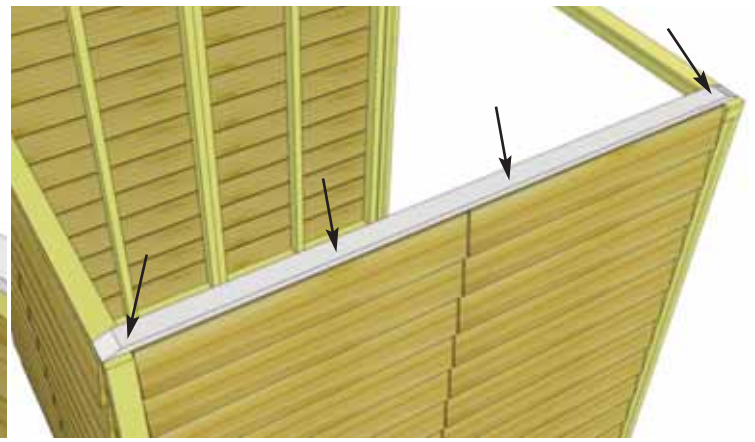

**24.** Position one **Side Top Plate** (angle cut on both ends) on top wall framing. Top Plate should be evenly spaced from front to back and aligned flush with the inside of wall framing. Attach into wall framing with 4 - 2" screws.

**25.** Position a **Front Top Plate** (angle cut on edge) on to top of wall framing. Butt the straight cut end up to Side Top Plate and align flush with the front of Door Header. When correctly aligned, attach into Header with 4 - 2" screws.

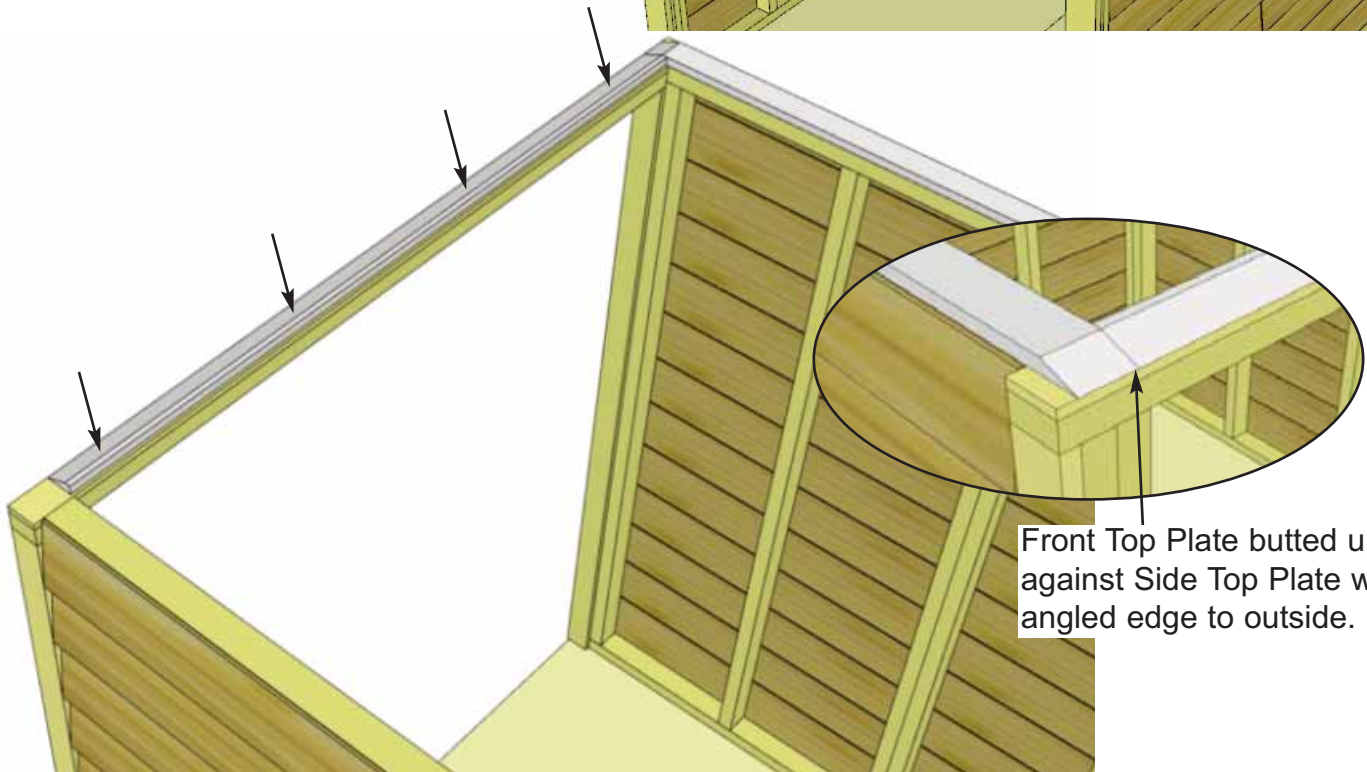
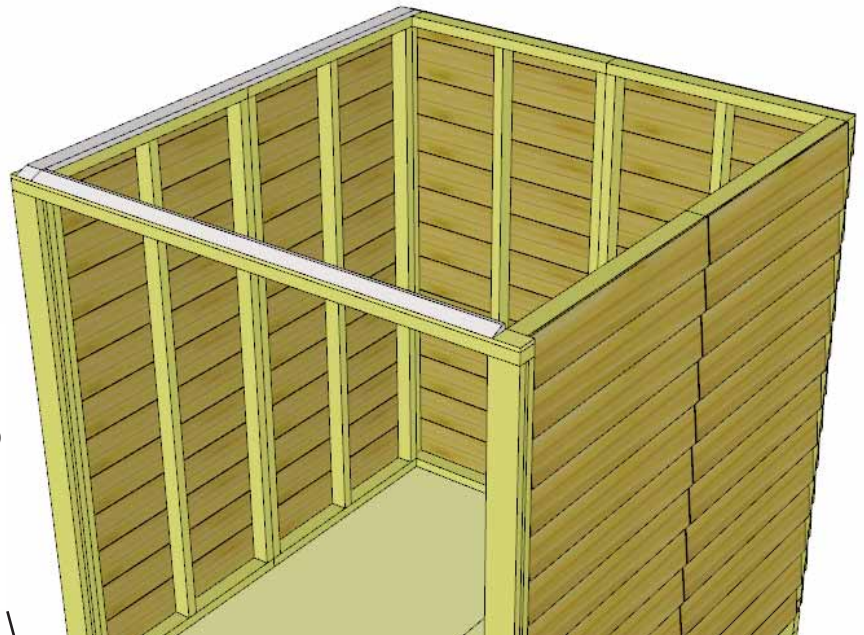

Front Top Plate butted up against Side Top Plate with angled edge to outside.

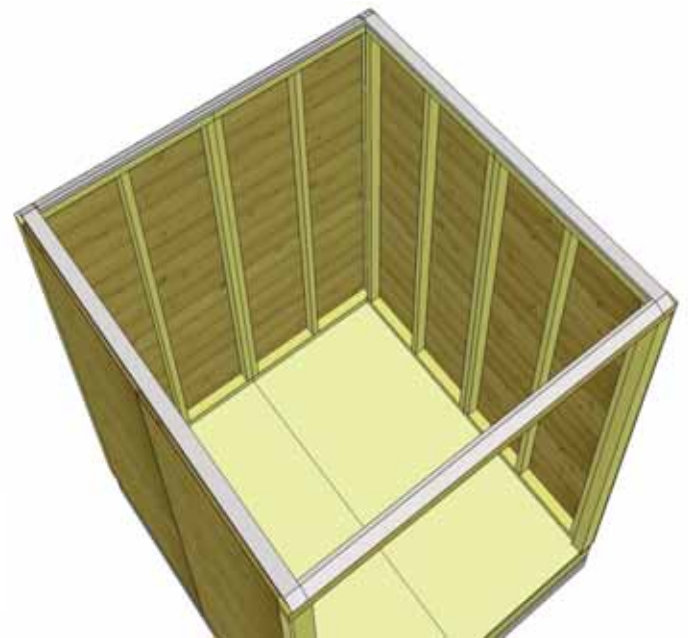

**26.** Complete remaining Side and Rear Top Plate attachments as per **Steps 24-25.**

**Important:** Prior to fastening walls and installing rafters, take time to confirm your walls are level, square and plumb. Measure diagonal at top and bottom of walls corner-to-corner. This should be approximately 95 1/2". More importantly, if measurements are not within 1/4", your walls are not square. Adjusting now will make it easier to install the roof section later.

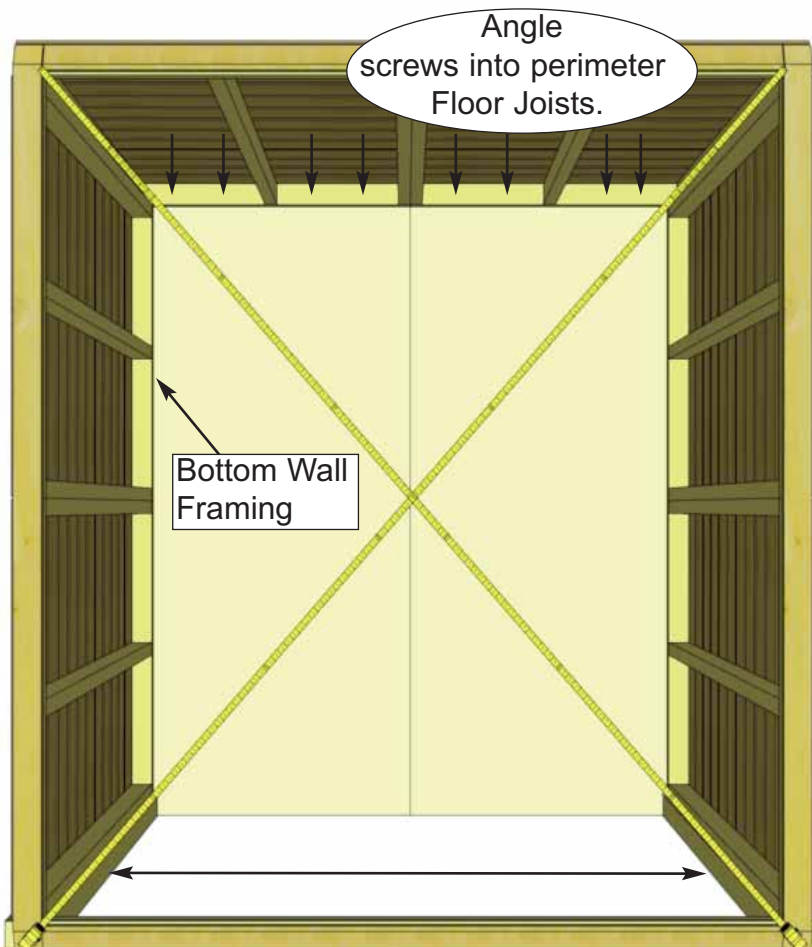

Confirm 64" Wide between Door Jambs

**27.** When all Walls and Top Plates are attached together, check wall and floor alignment. Bottom wall framing should sit flush with outside of floor joists. See **Steps 15-20** for correct alignment.

**Confirm Door Jambs are 64" apart at top and bottom of door opening.**

When positioned correctly, fasten bottom wall plates to floor using 4 - 2 1/2" screws per wall panel.

**Optional - Caulking** seams will help prevent moisture from entering at seam.  
**Caulking not included in kit.**

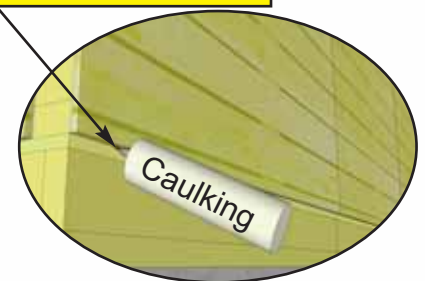



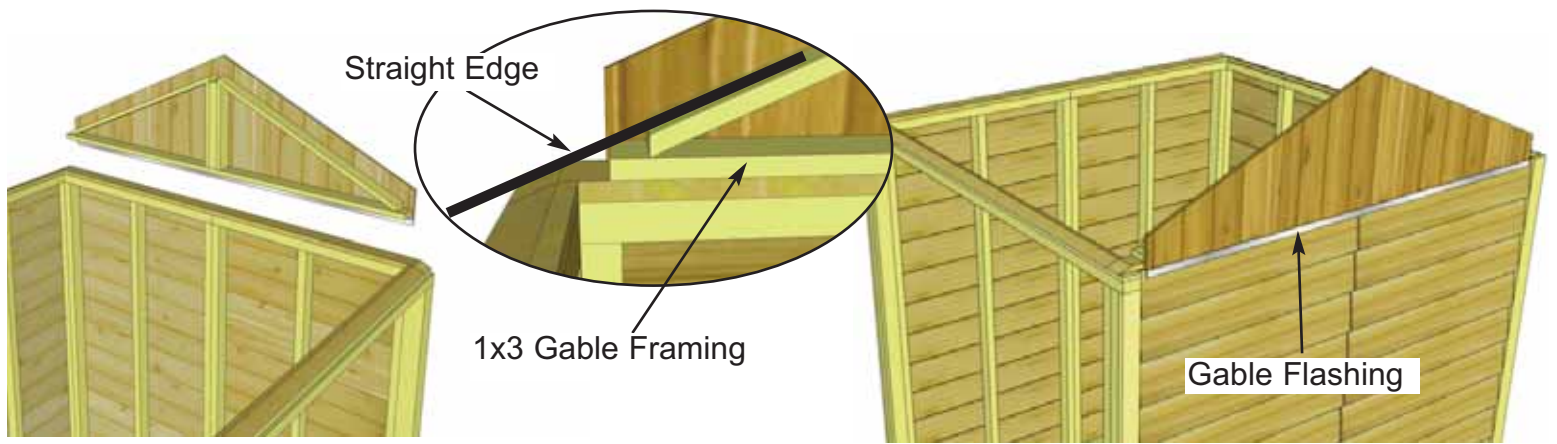

**28.** Place Gable so framing sits flush with the inside of the top plate. Center from front to rear using a Straight Edge to confirm angle of gable frame and Top Plate line up. Adjust gable accordingly. From the outside, make sure gable flashing overhangs wall siding.



**29.** Temporarily attach Gable to walls and top plate with 2 - 2" screws. Screw from the bottom of gable framing down into Top Plate and Wall. Gables may need slight adjustment in **Step 40** and then be completely attached with an additional 6 - 2" screws. Position 2nd Gable on side walls.

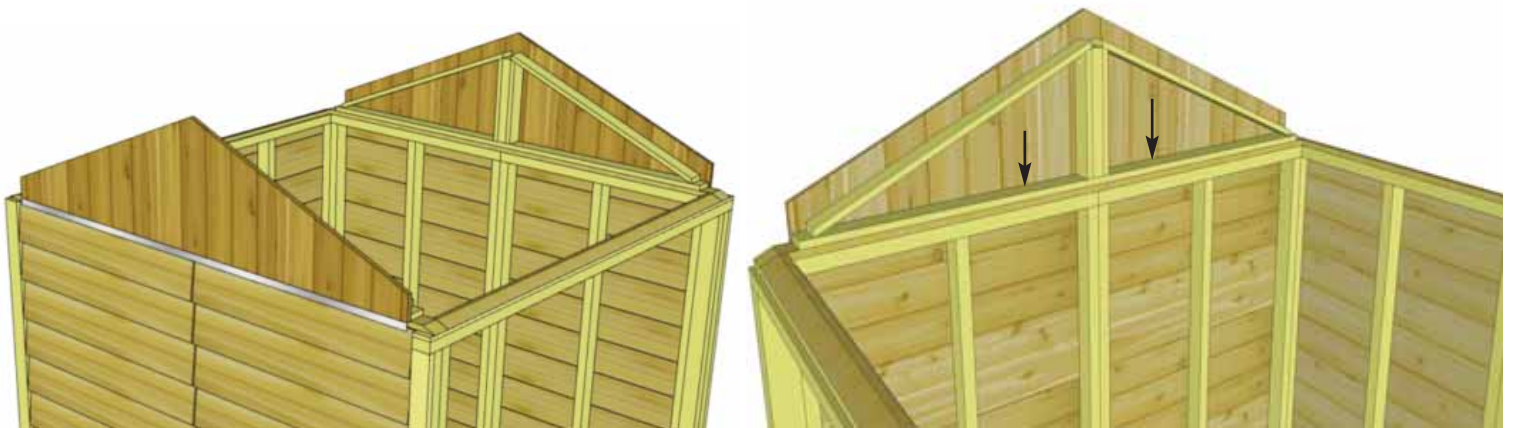

**30.** Position and temporarily attach 2nd Gable as per **Steps 28-29**.

# C. Rafter and Roof Section

Exploded view of all parts necessary to complete the Roof Section.  
Identify all parts prior to starting.

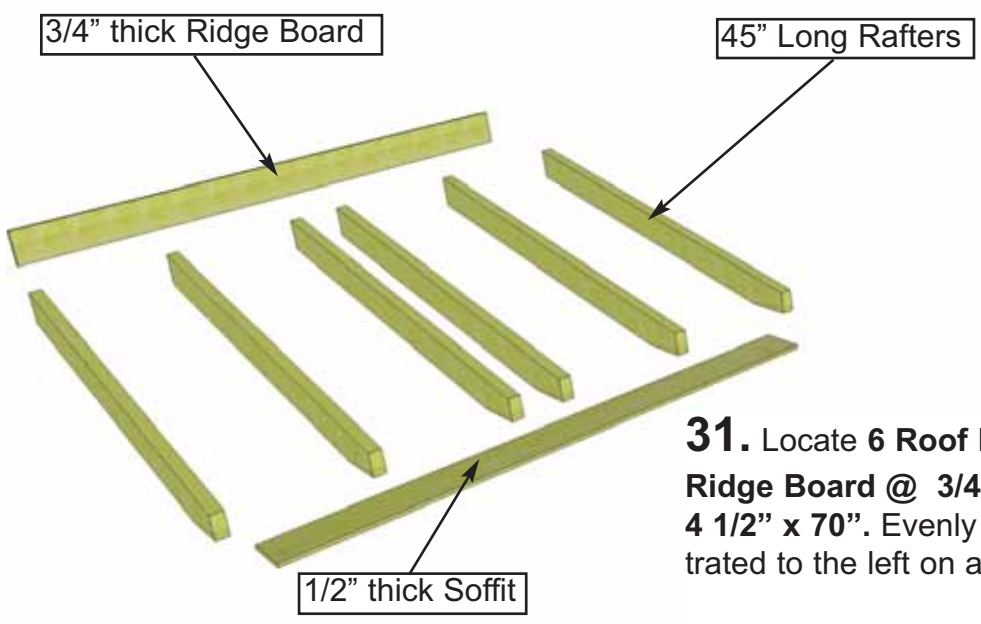
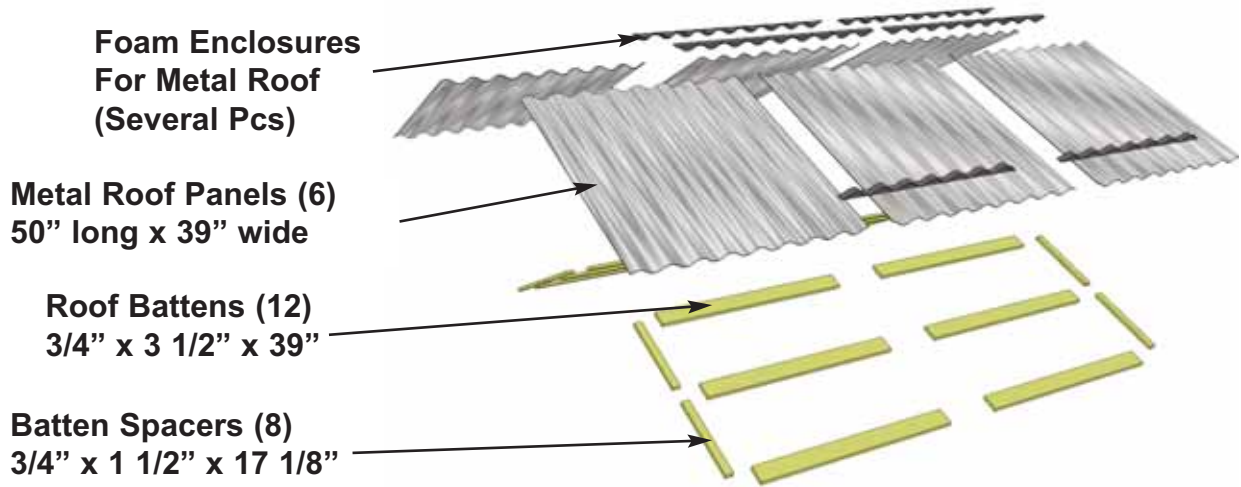
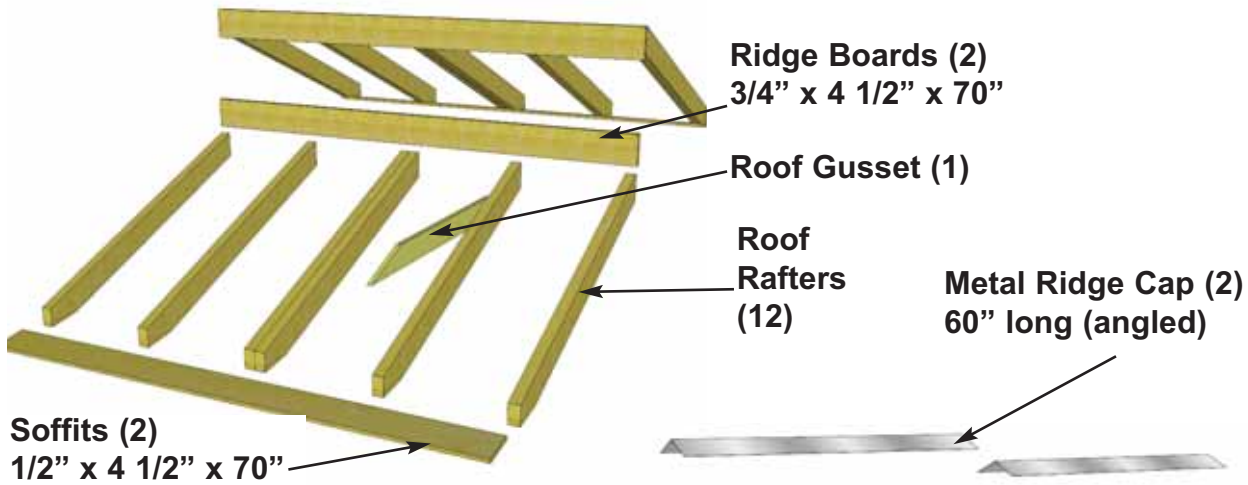

**31.** Locate 6 Roof Rafters @ 1 1/2" x 3 1/2" x 45", 1 Ridge Board @ 3/4" x 4 1/2" x 70" and 1 Soffit @ 1/2" x 4 1/2" x 70". Evenly space out Rafters and lay out as illustrated to the left on a flat level surface.

**32.** Attach Ridge Board to ends of both outside rafters with **2 - 2" screws** per end. Drill 1/8" pilot holes in Ridge Board to prevent splitting. Measure and position interior Rafters as illustrated below. Double up center rafters and screw together with **2 - 2 1/2" screws** first. When positioned correctly, attach Ridge Board to remaining rafters with **2 - 2" screws** /rafter end.

**Important:**  
Pilot Hole Ridge Board and Soffit prior to screwing to prevent splitting!

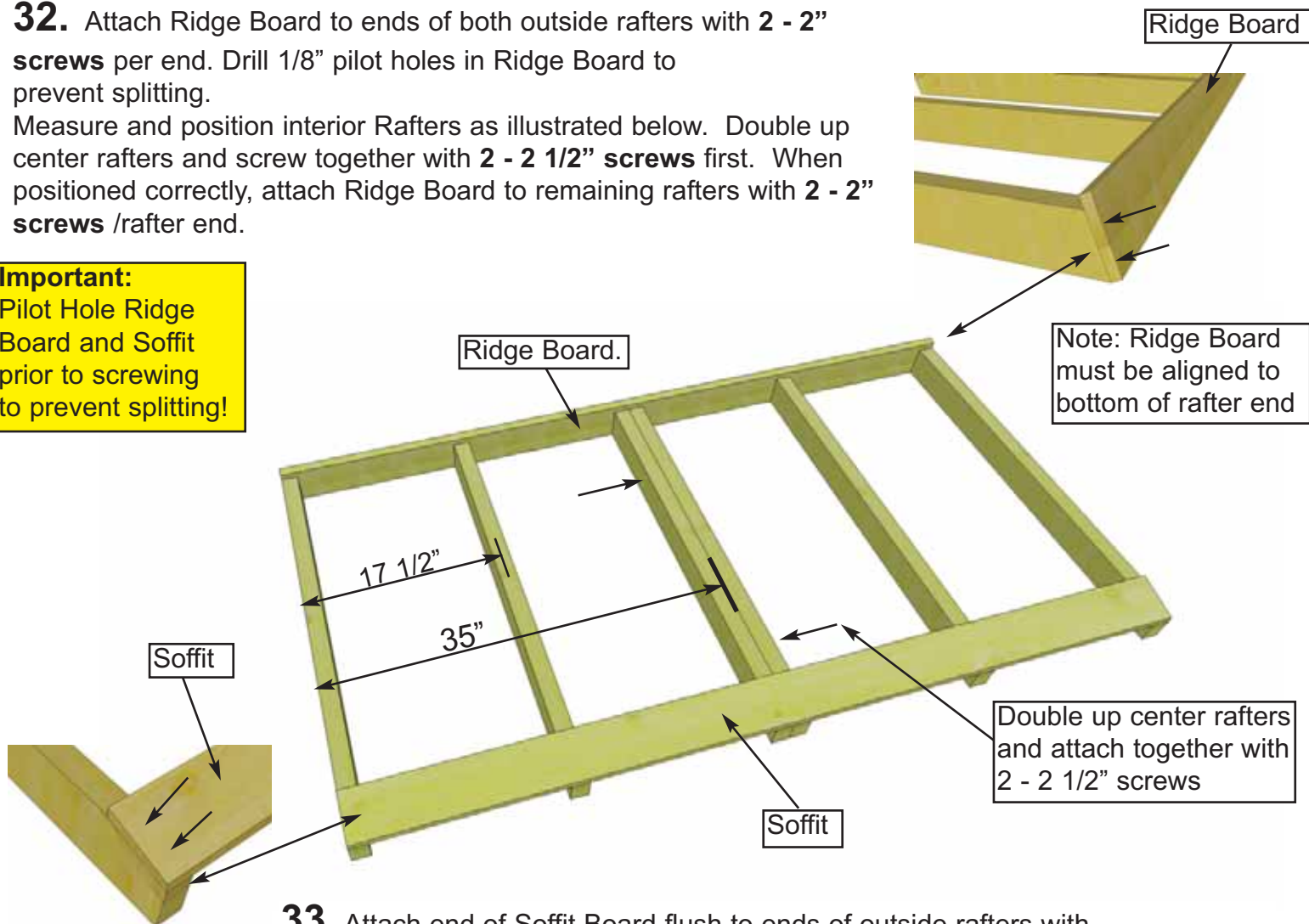

**33.** Attach end of Soffit Board flush to ends of outside rafters with **2 - 1 1/4" screws** per rafter end. **Drill pilot hole in soffit ends to prevent splitting.** Complete both outside rafter / soffit connections first. Measure and position interior rafters as illustrated above. When positioned correctly, attach soffits to remaining rafters with **2 - 1 1/4" screws**/rafter.



**34.** Complete 2nd Rafter section now as per **Steps 32 - 33.**

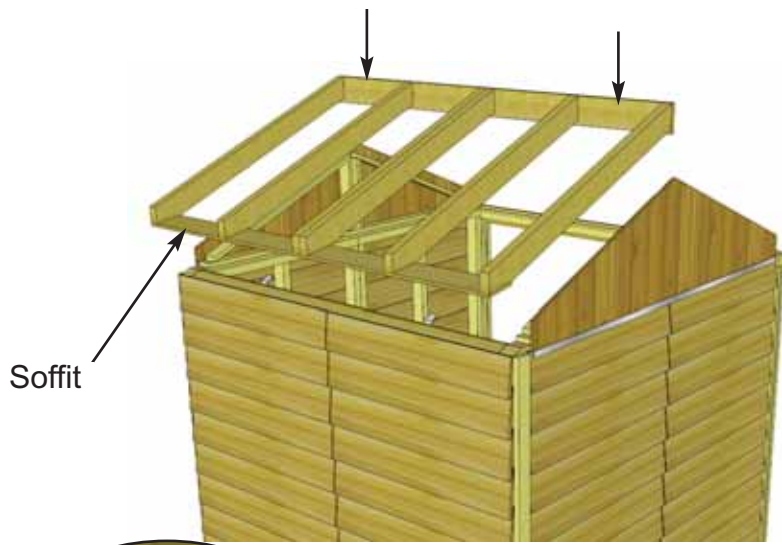

**35.** Starting at the rear, lift a completed rafter section up and place on gable framing.

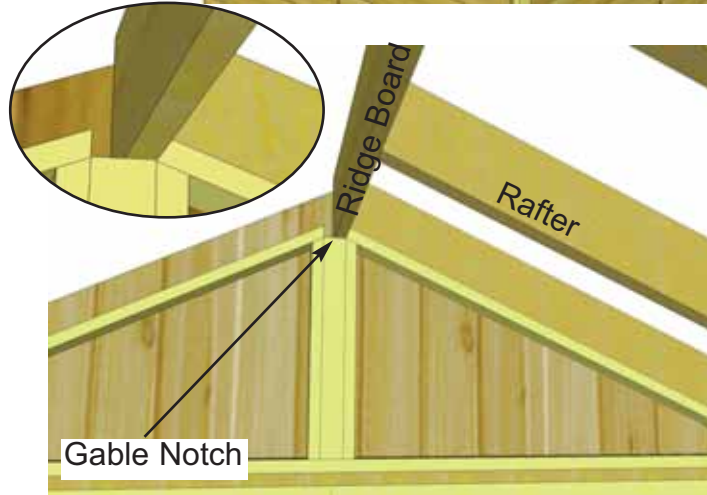

**36.** Slide Rafter Section up on gable framing until bottom of Ridge Board slips into gable notch.

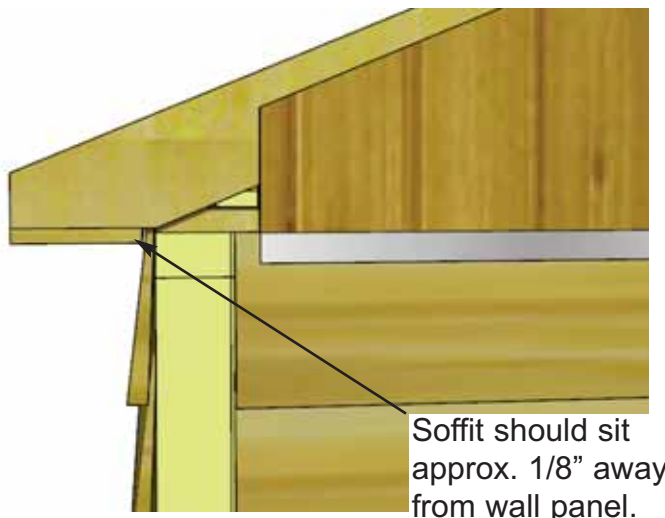
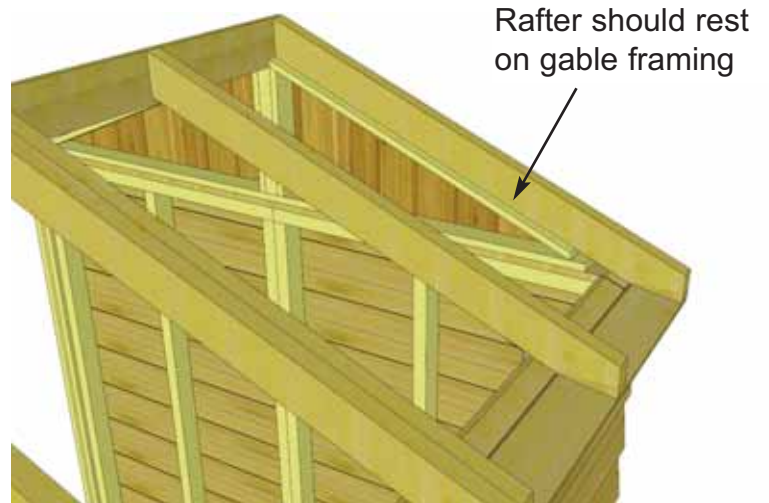

**37.** When Rafter Section is correctly positioned, outside rafters will sit equally on gable framing and Soffit will sit approximately 1/8" away from wall panels.

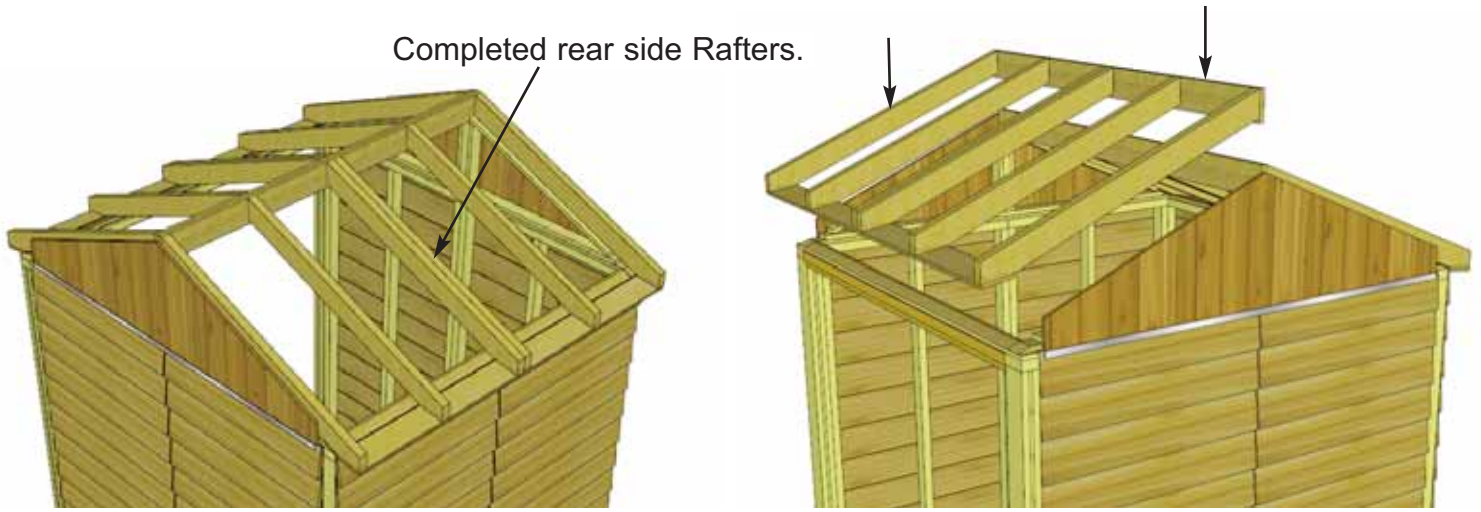

**38.** Place 2nd completed Rafter Section on gable wall framing. Position as per **Steps 35 - 37.**

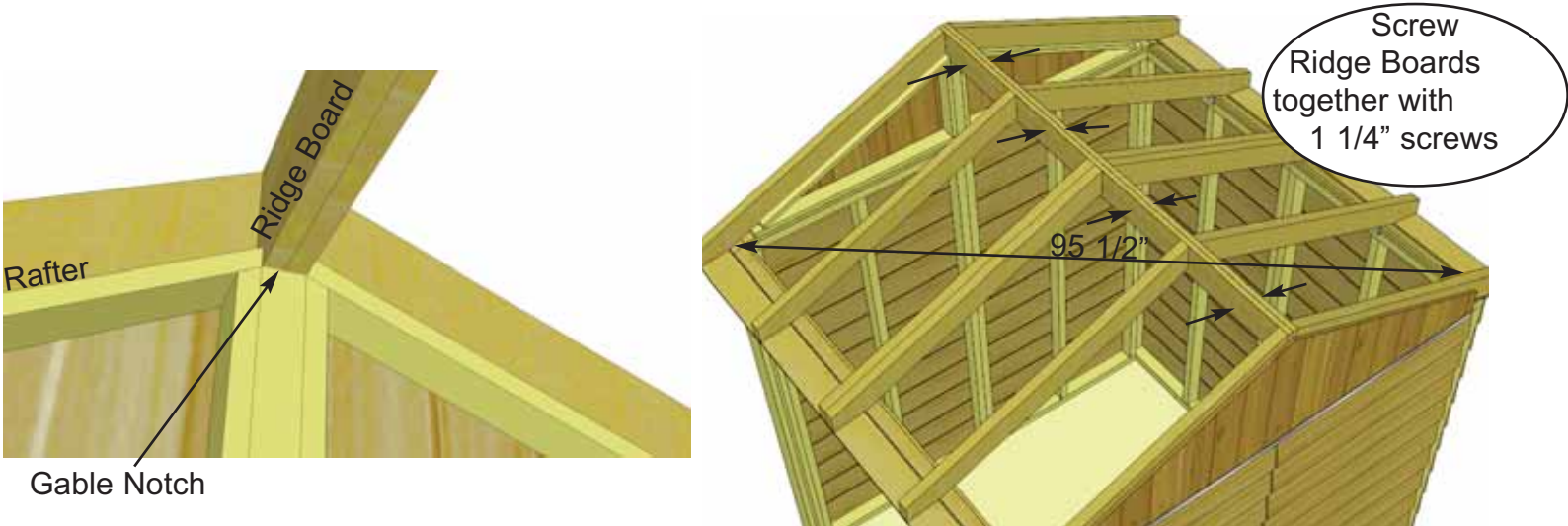

**39.** With Ridge Board locked into gable notch, align Ridge Boards so they are flush together and secure them with 8 - 1 1/4" screws. **Important-** if there is a gap between Ridge Boards, try pushing rear wall and Door Header closer together from outside. Before moving on with further steps, confirm your shed is square at wall height by checking the diagonal distance of the top walls on the inside. In both directions, the distance should be approximately **95 1/2"** depending on where you measure. It is important that both diagonal measurements are approximately equal. If not, adjust walls until an equal distance is achieved.

**40.** With both Ridge Boards connected, completely secure Gable framing to walls and rafters. Use 3 - 2" screws per Rafter. Use an additional 6 - 2" screws to secure Gable to wall.

**Note-** you may have to remove the 2 temporary screws in Gable from Step 29 and reposition Gable for best fit prior to completing gable attachment.



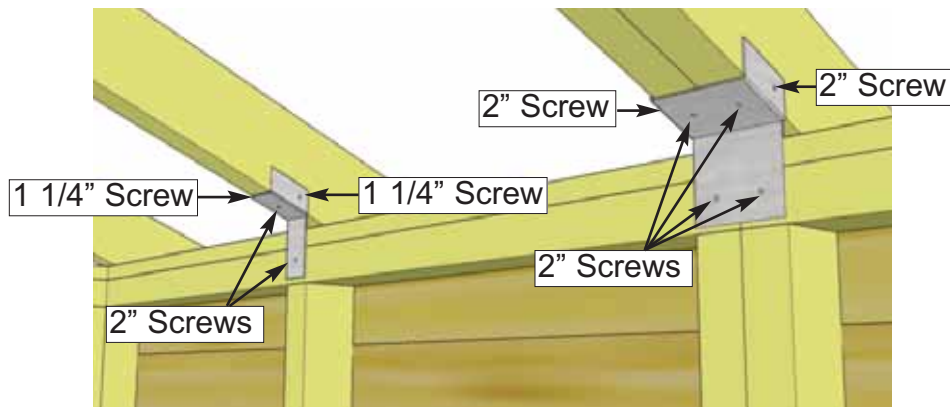

**41.** Attach all **Single** and **Double Rafter Brackets** where rafters meet **Top Wall Plates** inside of shed. Attach with **2 - 1 1/4" screws** and **2 - 2" screws** per **Single Bracket** and **6 - 2" screws** per **Double Bracket**.

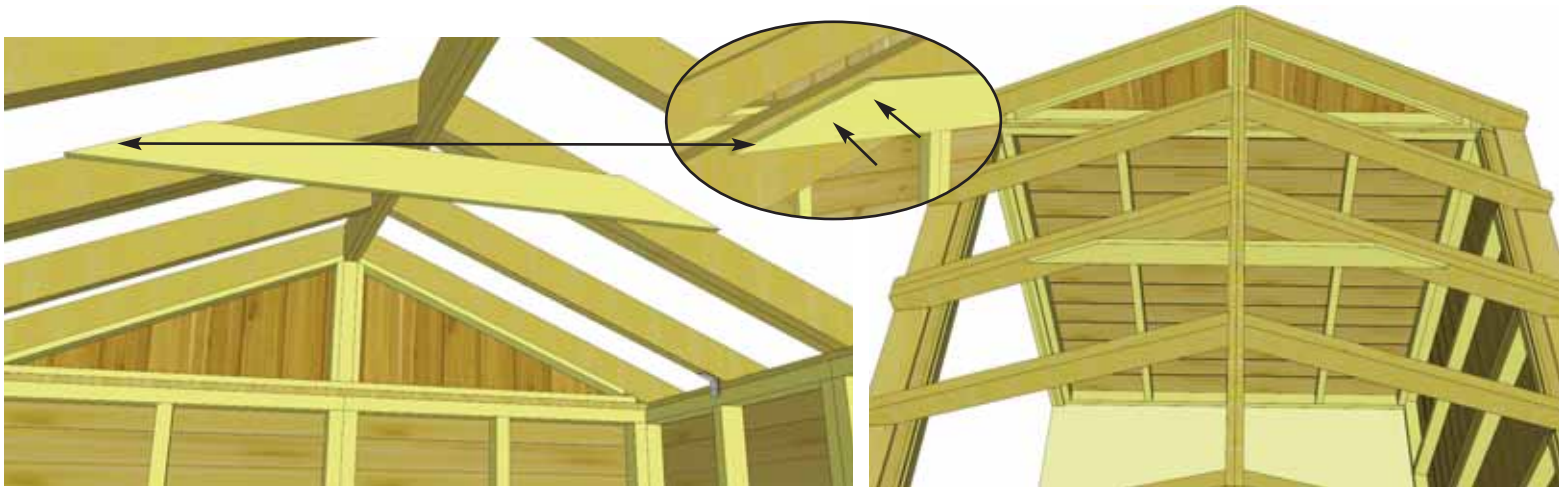

**42.** The **Roof Gusset** is positioned on center rafter. When correct, slide gusset up, use level to square gusset and attach to rafter with **4 - 1 1/4" screws**. **Pilot hole Gusset to prevent splitting.**

**Important:** Pre-drill pilot holes with 1/8" bit to prevent rafters from splitting.

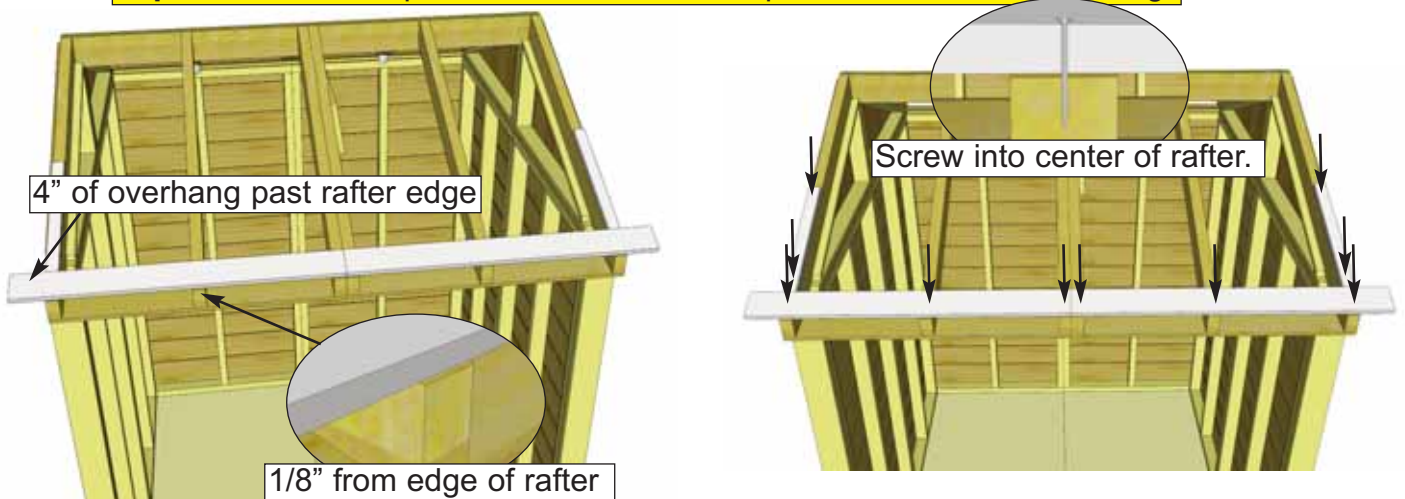

**43.** Locate first two **Roof Battens (3/4" x 3 1/2" x 39")** and place on rafters 1/8" from front edge. Batten will overhang outside rafters by approximately 4" on each side. Before attaching Batten to rafters pre-drill pilot hole with 1/8" bit to prevent rafters from splitting. Secure Batten to rafters with **6 - 1 1/4" screws**. Drill into center of rafter. Secure 2 **Batten Spacers** against each batten with **2 - 1 1/4" screws**. Batten Spacers are flush with rafter edges.

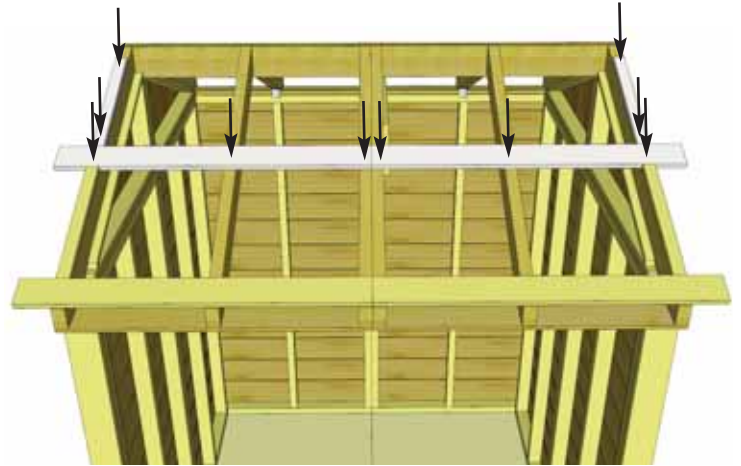
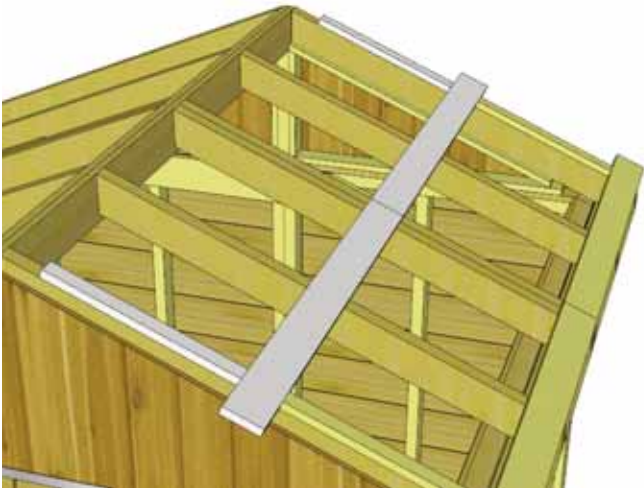

**44.** Place second pair of **Battens** flush with first pair of Batten Spacers. Secure with a second pair of Batten Spacers as per **Step 43**.

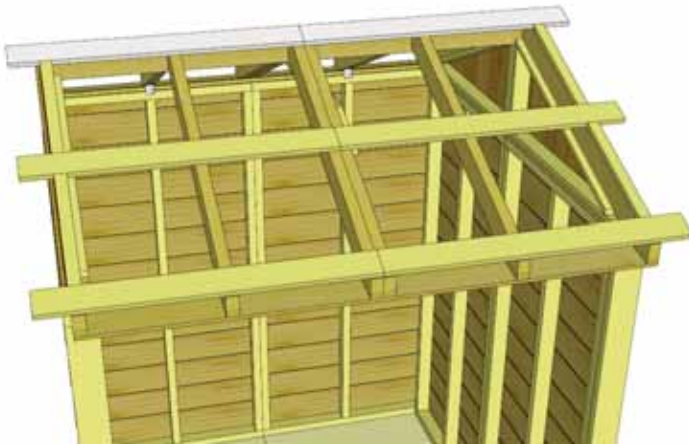

**45.** Place third pair of **Battens** flush with second pair of Batten Spacers. Secure as per **Step 43**.

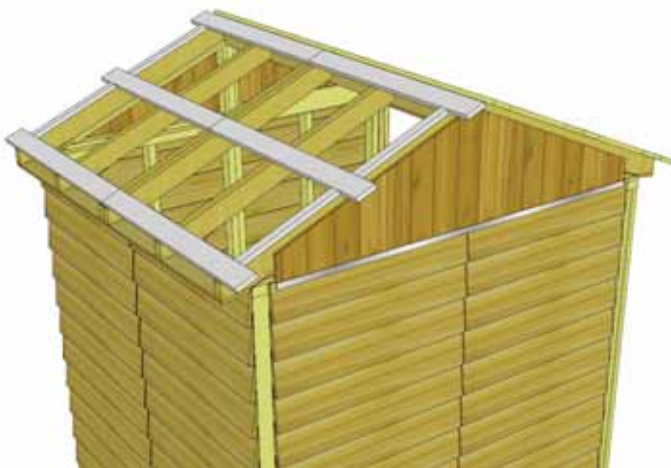

**46.** Complete opposite side of roof using remaining **Battens** and **Batten Spacers** by following **Steps 43 - 45**.



**47.** Locate all **Metal Roof Panels (6 pcs x 39" wide x 50" long - Identical)**. Starting with one side (3 panels), place the first outside panel on rafters. Panel should overhang low side of rafters slightly and not exceed the apex of the ridge boards.

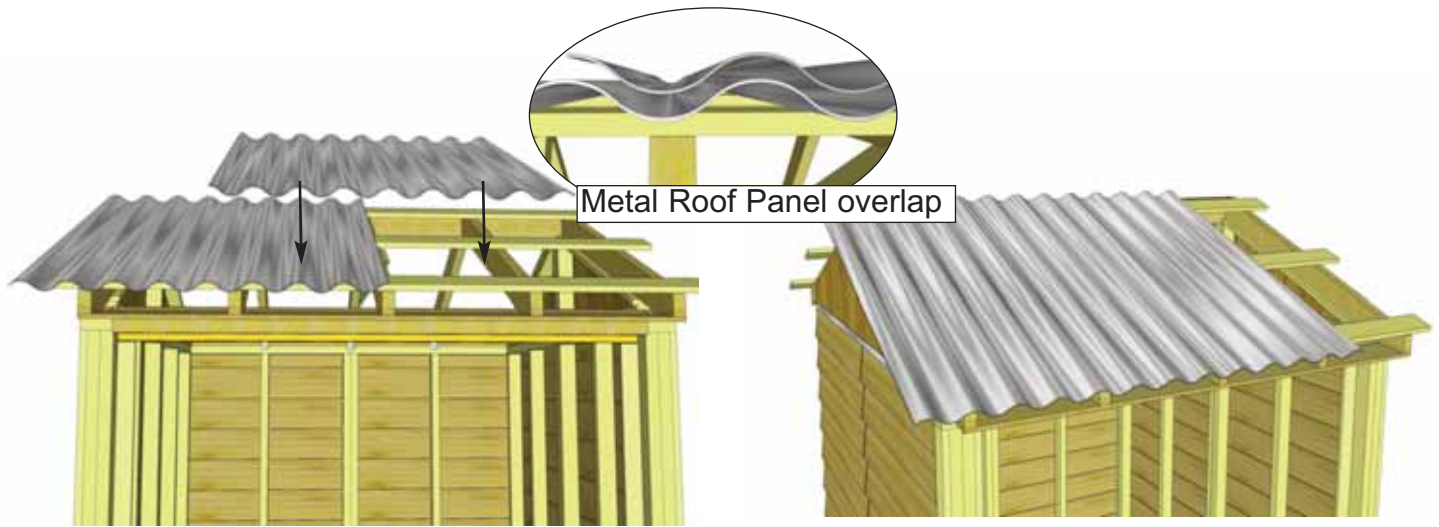

**48.** Do not attach **Metal Roof Panels** onto battens until all panels are positioned and spaced. In the meantime, have your helper hold the panel in place so it doesn't slide off. Locate 2nd panel and place on battens and overlap panel with the first outside panel as shown above.



**49.** Locate and place 3rd panel onto roof as per **Steps 47 - 48**. On the ends panels should overhang battens by approximately 2" on both ends. Adjust as necessary. Once **Metal Roof Panels** are spaced correctly from side-to-side and top-to-bottom, lift panels and run a bead of caulking down the overlapping seams of each panel to seal the joints.



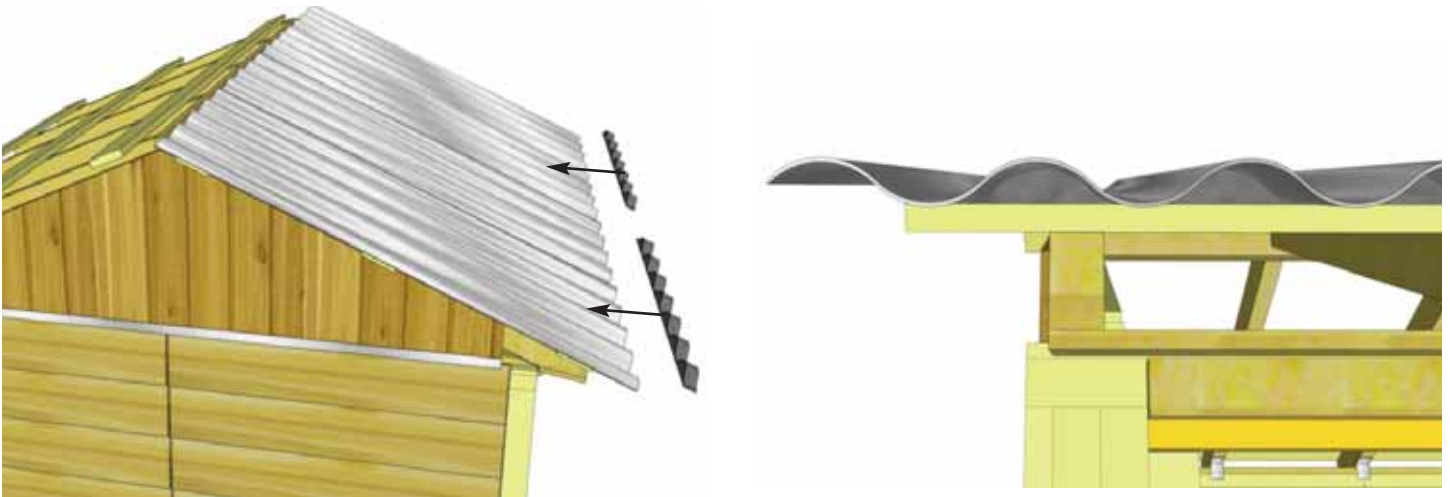

**50.** Locate Foam Enclosures for Metal Roof. Before attaching roof panels down, insert Foam Enclosures between roof panels and battens.

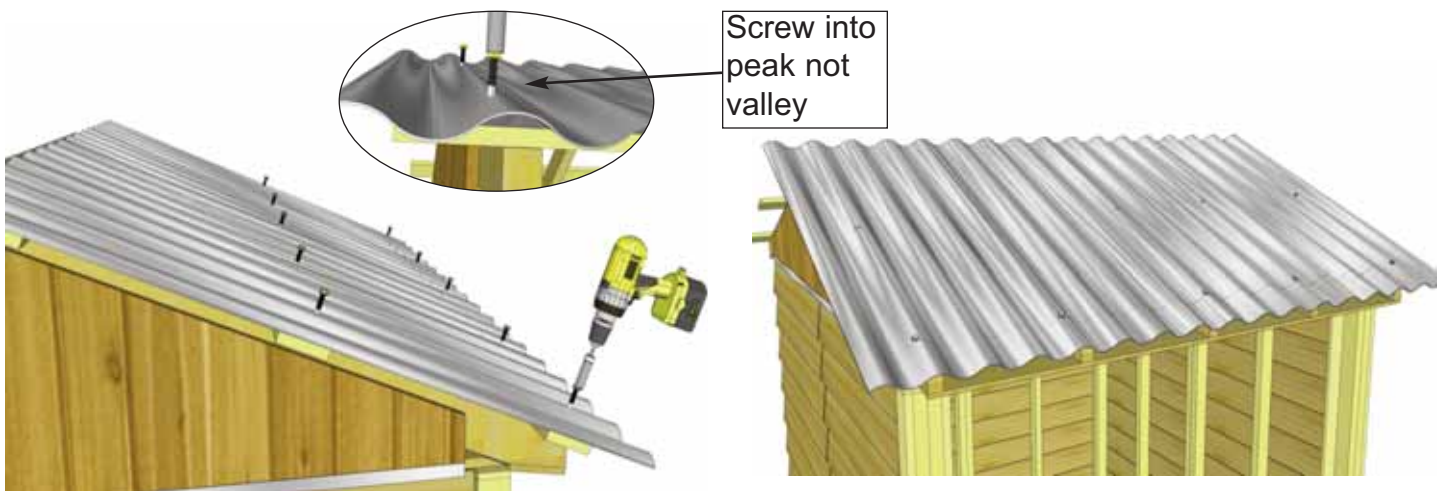

**51.** Using 10 - 1/4" x 2" Metal Roof Screws and 1/4" Nut Driver, secure outside panel down to each batten. Screw into peak of roof panel not valley. Metal screw is self-tapping. Do not over tighten!

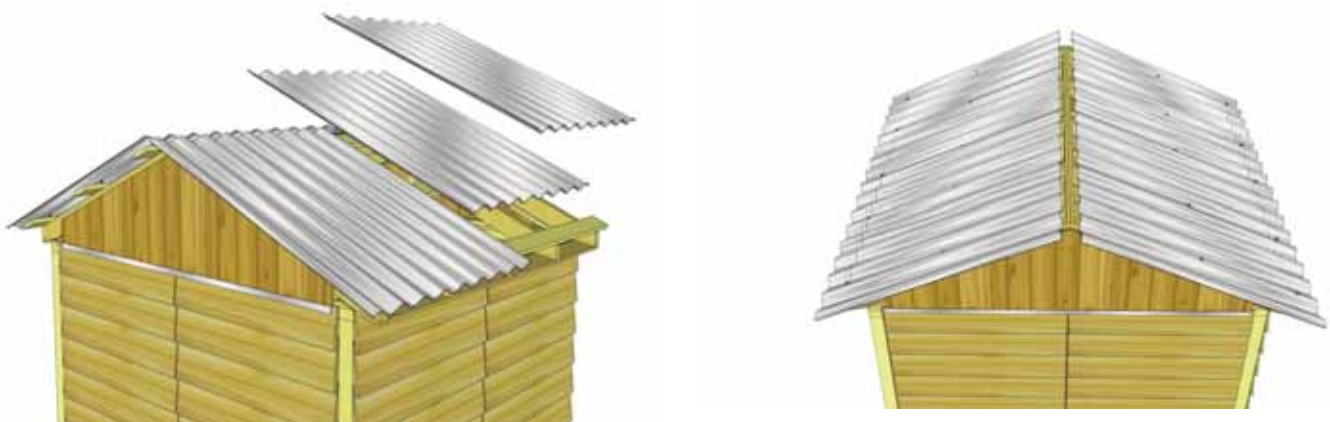

**52.** Complete the opposite side of the roof with 3 remaining metal roof panels following **Steps 47 - 51.**



**53.** Before attaching Metal Ridge Caps, place strips of **Foam Enclosures** near to top. Enclosures will prevent moisture from coming in the top. Complete both sides.

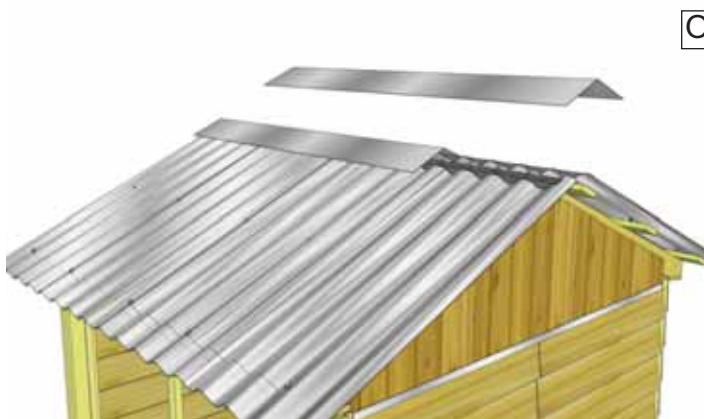

Overhang by 1-2"



**54.** Locate and place **Metal Ridge Caps ( 2 pieces - 60" long)** on apex of roof. Evenly space from front to back. Caps will overlap each other. Overhang the cap approximately 1-2" past each end.



# D. Miscellaneous Section

Exploded view of all parts necessary to complete the Miscellaneous Section. Identify all parts prior to starting.

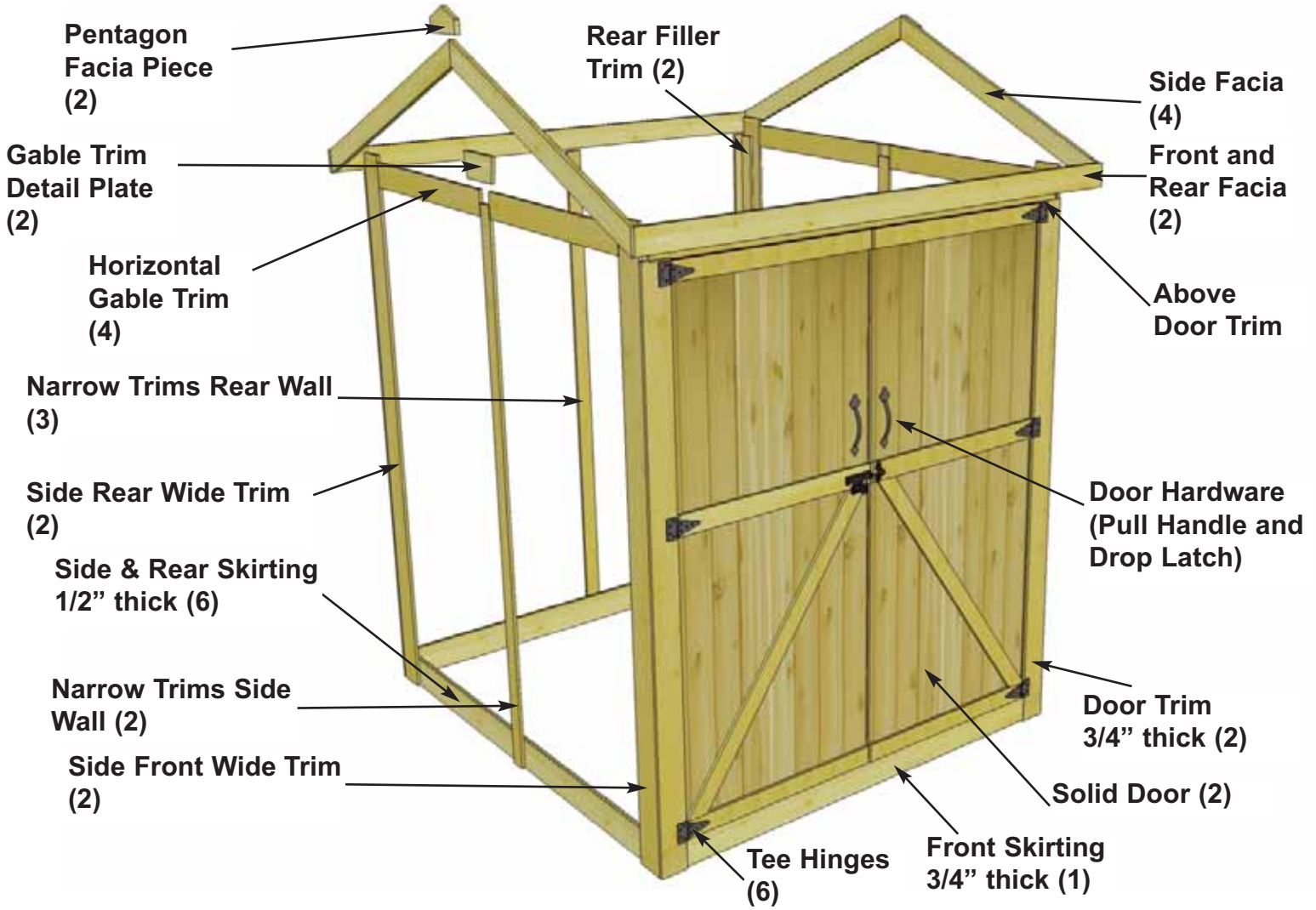

**Note** - missing from exploded drawing:  
Interior Cane Bolt, Horizontal and Vertical Door Stops, Door Threshold.

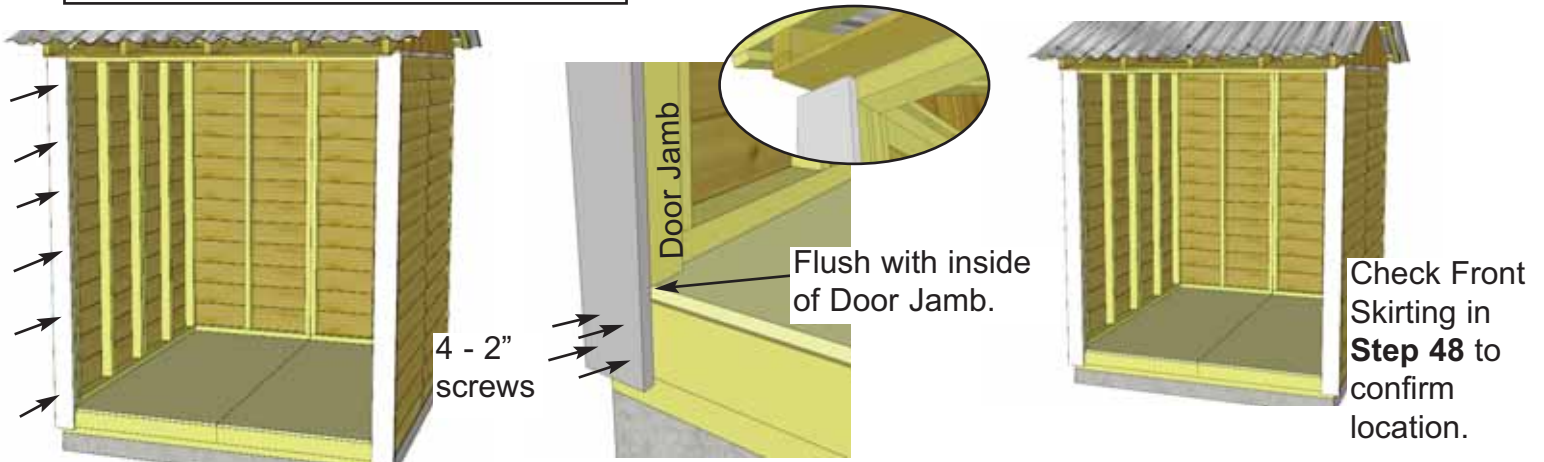

**56.** Locate both 3/4" x 4 1/8" x 79" Door Trims. Position a Trim so it covers the Door Jamb and is flush with the inside of it. Secure with 6 - 1 1/2" finishing nails. At the bottom, use 4 - 2" screws. Complete both Door Trims. **Important- Drill 1/8" pilot holes in bottom of Door Trims to prevent wood from splitting.**



**57.** Position **Front Skirting** (3/4" thick) between Door Trims aligning it even at top edge with floor. Use 6 - 1 1/2" nails to secure.

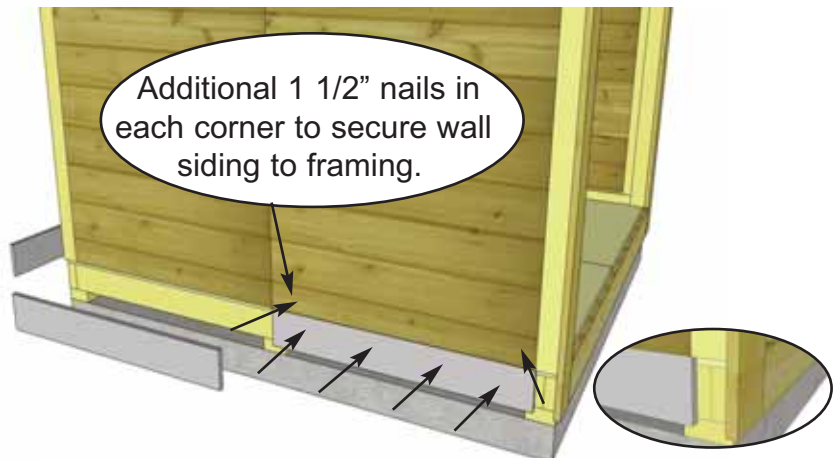

**58.** Attach **Side and Rear Skirting** around the base of the shed. Skirting will hide floor framing. The side skirting pieces will meet together in the center. Gaps on outside will be covered by Wide Trim pieces later. Use 4 - 1 1/2" nails to secure. Further secure bottom siding to wall framing in corners on each wall panel with 2 - 1 1/2" nails.

**59.** Attach **Rear Filler Trim** (5/8" x 2 1/2" x 75") to rear walls in each corner. Hammer with 6 - 1 1/2" finishing nails. Strips are positioned flush with siding and bottom Skirting.

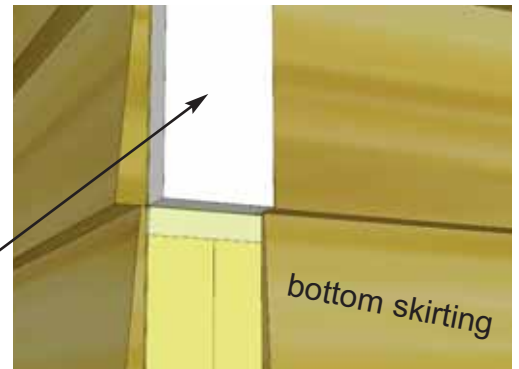

flush with wall siding

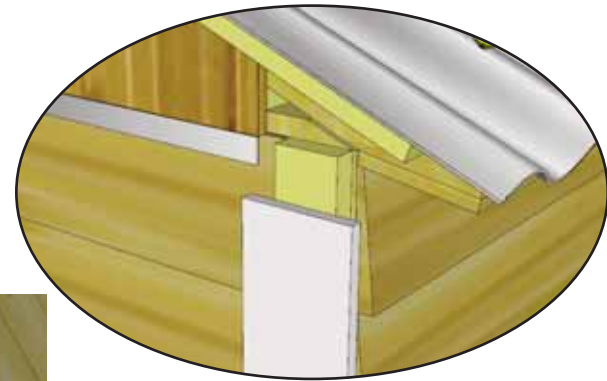
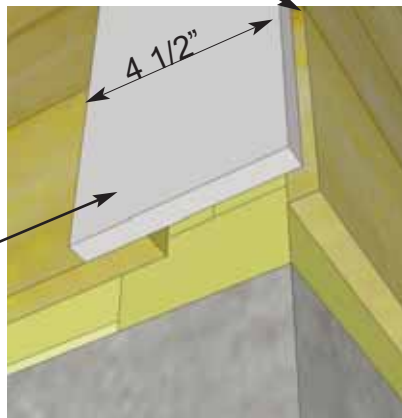

**60.** Attach **Side Rear Wide Trims** (1/2" x 4 1/2" x 77 1/2") over filler trim. Use 8 - 1 1/2" finishing nails per piece. Once again, edge of trim should be flush with wall siding. See **Step 61** for corner trim alignment.

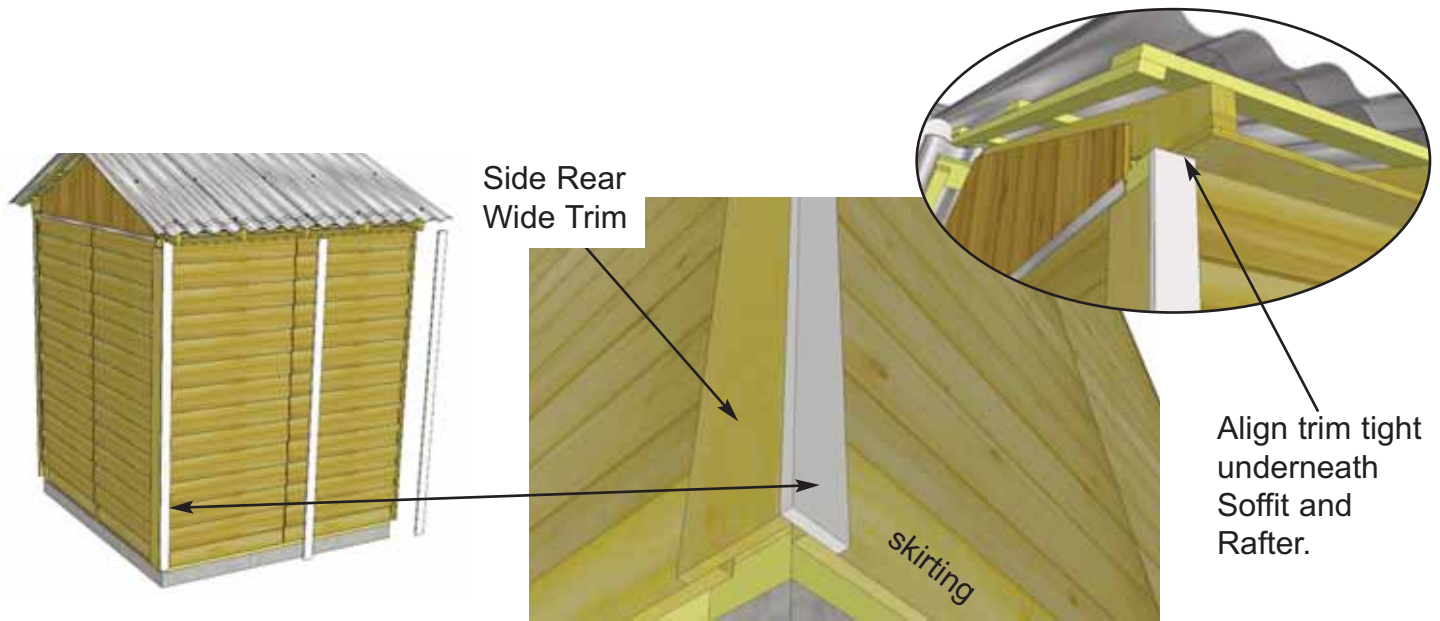

**61.** Attach **Narrow Trims (Rear Walls)** to in each rear corner and middle wall seam (3 - 1/2" x 2 1/2" x 79"). Use 8 - 1 1/2" finishing nails per piece. Align Trims tight underneath Soffit and Rafter and so it caps the Side Rear Wide Trim.

**62.** Position and attach **Side Front Wide Trims and Narrow Trims (Sides)**. Use 8 - 1 1/2" nails per piece to secure.



Side Front Wide Trim



Narrow Trim



Cover wall seam



Detail Plate

**63.** Attach **Horizontal Gable Trim** (4- 1/2" x 4 1/2" x 37 7/8") to both sides of shed. (2 per side). Position over gable and wall seam. Use 4 - 1 1/2" nails to secure each piece. Make sure gable trims covers flashing completely. Align even with outside of wide trim leaving a slight gap a center. Attach **Horizontal Detail Plates** over Gable Trim seam and secure with 4 - 1 1/2" nails. Complete both sides.

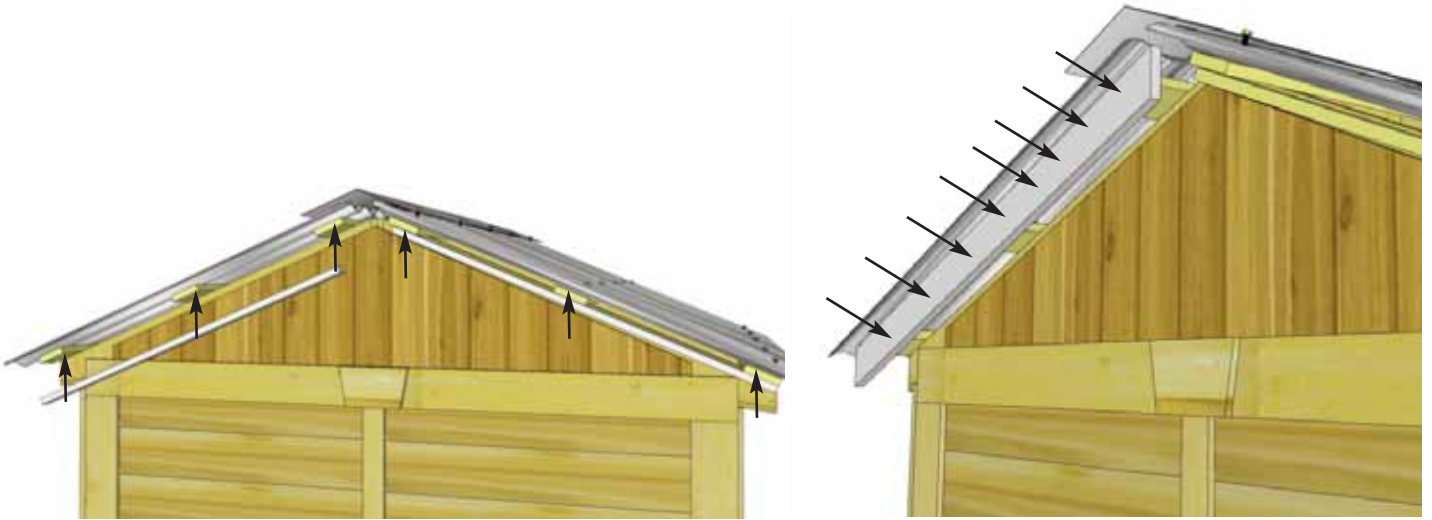

**64.** Attach **Facia Nailing Strips** (4 - 3/4" x 1 1/2" x 42") to underside edge of roof battens with 3 - 1 1/4" screws per piece. Do this on both sides of the shed. Locate **Side Facia** (angle cut on both ends). There are 2 left and 2 right side pieces. Correct positioning is rough side out. Starting on one side, line facia up so the end is even with edge of roof battens. Attach to nailing strip with 8 - 1 1/2" nails. Align 2nd Side Facia piece up with batten edge. Note that there will be a slight gap where facias meet at the peak. This will be covered up with the Pentagon Facia Plate in Step in **Step 66**. Attach with 8 1 1/2" nails.

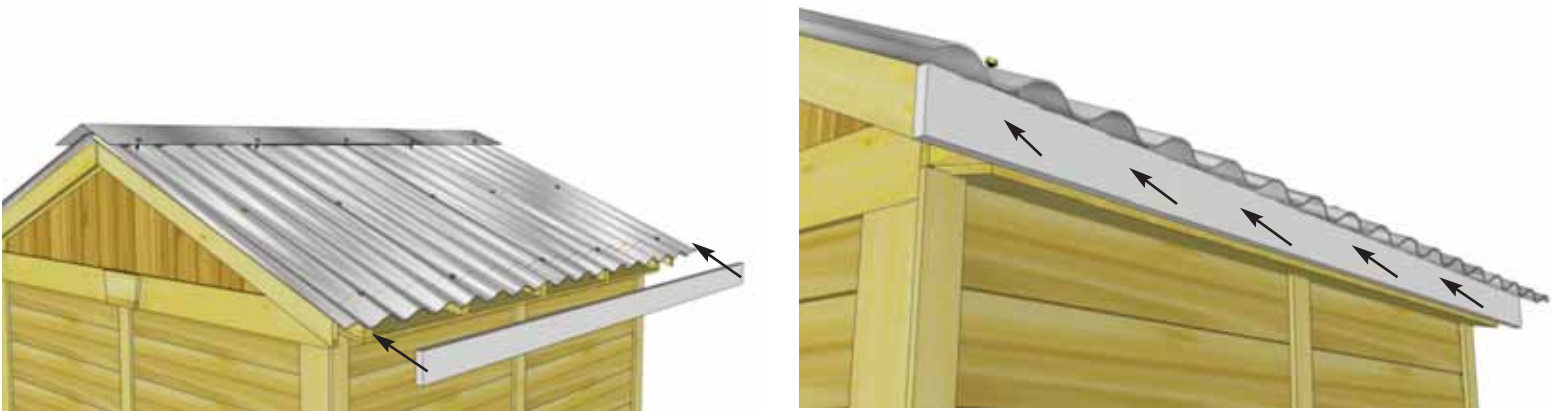

**65.** Position and attach **Front Facia** to ends of Roof Rafters with 10 - 1 1/2" nails. Front Facia will cap side facia in corners and line up with ends of Battens.



**66.** Complete remaining facia pieces. Attach **Pentagon Facia Plate** where Side Facia meet at the peak. Use 4 - 1 1/2" finishing nails per piece to secure.



Attach Black Tee Hinges with 3/4" & 2" Black hardware provided



**Important-**  
Drill Pilot Holes  
to prevent  
splitting

**Note,** illustration of Hinge may not be accurate. The # of screw holes in the hinge may vary from three to four depending on model.

**67.** Attach Door Hinges to both **left** and **Right Side Double Doors**. Position Hinges equally on door trim as shown above and attach with Black 3/4" and 2" screws.



**68.** Next, position and secure the Double Doors. Starting with **Left Side Door**, position so there is a 1/2" gap on bottom and approximately 3/8" on the side. Use a spare Shingle to shim door in place at the bottom.

**Important-**  
Drill Pilot Holes  
to prevent  
splitting

3/8" on  
side.  
1/2" gap  
at bottom.

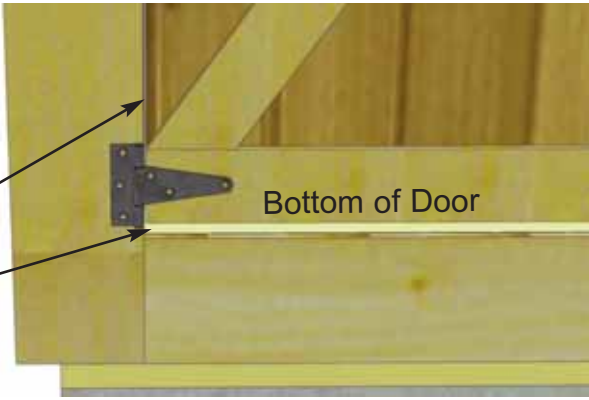

2" Black  
Screws

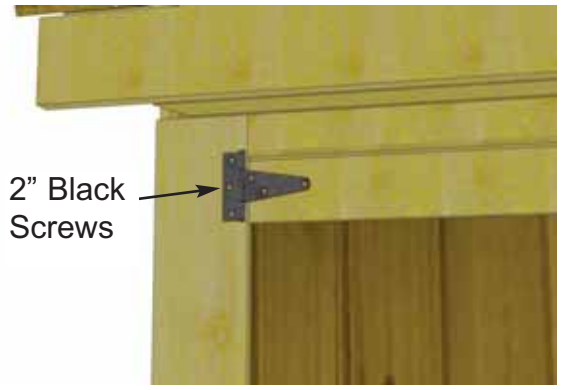

**69.** With Door correctly aligned, attach Door Hinge to Door Trim with 2" black screws. **Hint:** Do not attach all the 2" screws in each hinge until both doors are positioned correctly into place. Drill pilot holes in Door Trim prevent wood from splitting. When satisfied with door positioning, complete all 2" screws then.



**70.** Position and attach **Right Side Door** as per **Steps 67-69**. Door position may need slight adjusting to open and close correctly. When satisfied, complete all 2" screws. **Note,** Do not over tighten hinge screws when using screw gun.

Above Door Trim



**71.** Place **Above Door Trim** on door header between door trims. Attach with 6 - 1 1/2" nails. Leave small gap to allow for proper door opening and closing.



Hor. Door Stop with Dado cut.

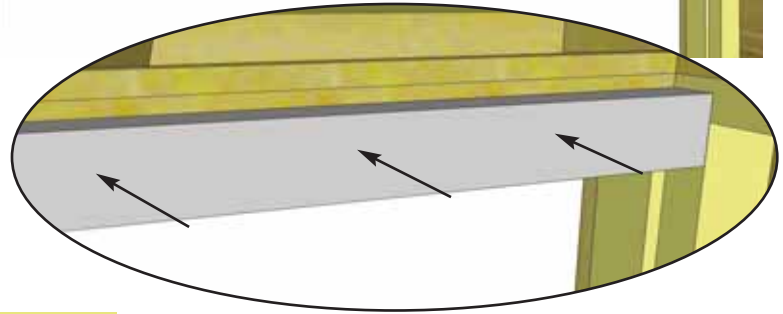
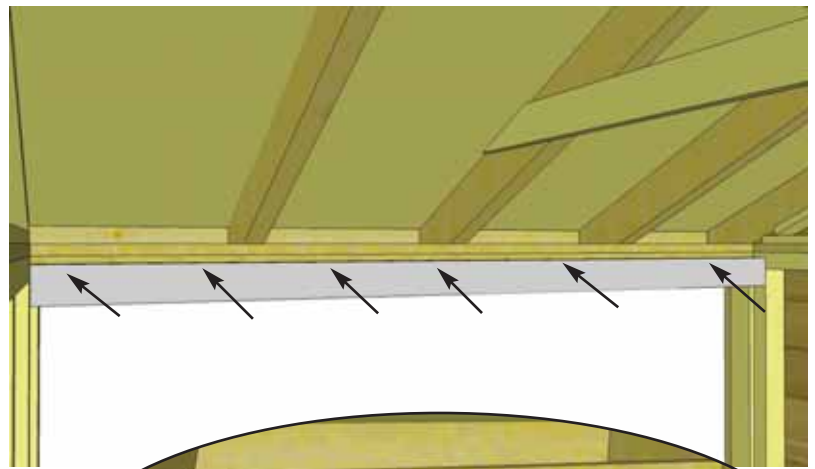
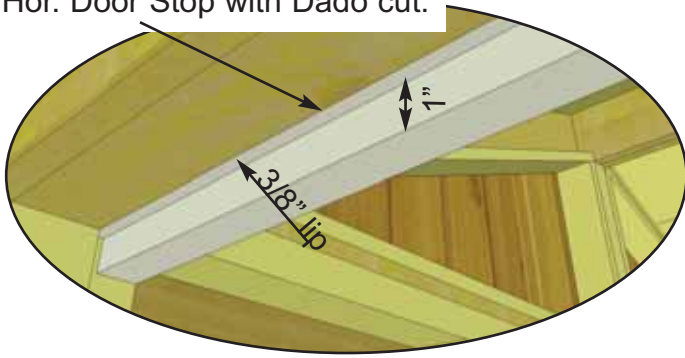

**72.** Position Horizontal Door Stop with dado facing out, tight against Door Header. Align so Dado cut is flush with Header leaving approximately a 1" overhang in the doorway. Attach with 6 - 2" screws.

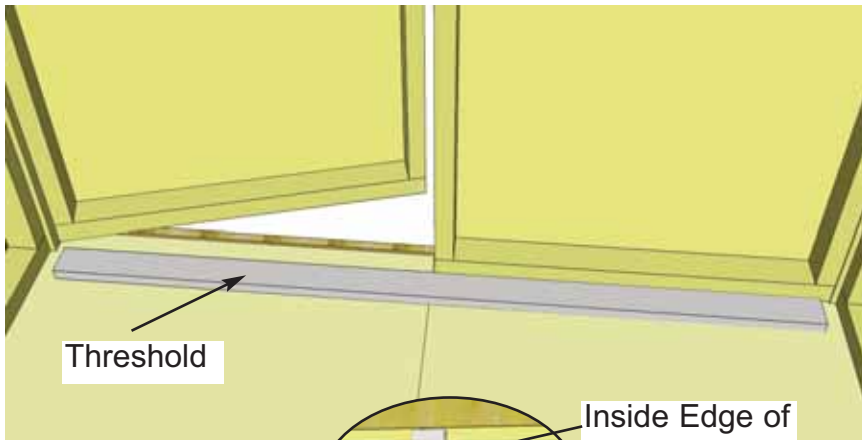

**73.** Close both doors and align so doors are straight. Attach Door Threshold (2 1/2" wide x 62 1/2" long) with 4 - 2" screws centering between doorway.

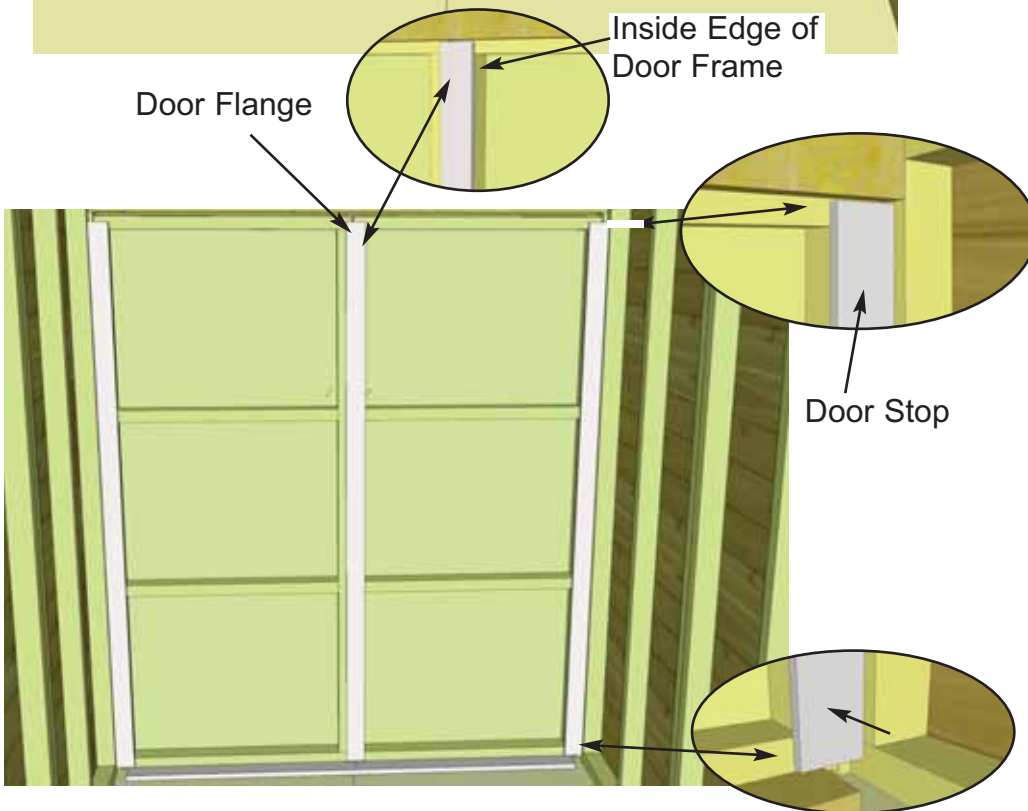

**74.** Position and attach Door Flange and both Door Stops to door framing. Starting with the Door Flange Position and attach on inside door frame (**left door from outside**) using 6 - 2" screws. Position on inside edge of door frame so Flange overlaps door frame by 1". Position Door Stops in each corner screwing into door framing. Before attaching stop to door, check positioning to confirm Door Stop does not bind and adjust accordingly. Attach with 4 - 2" screws.

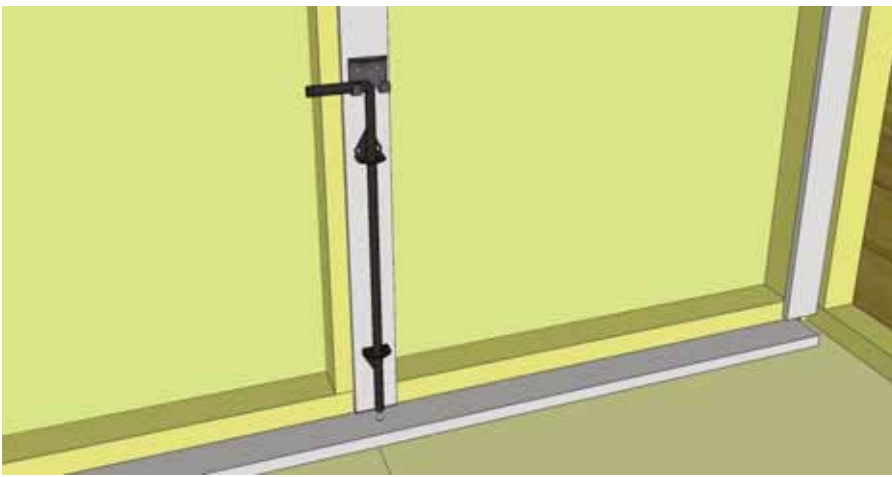

**75.** The **Interior Cane Bolt** will be attached to Vertical Door Flange. To position Cane Bolt correctly, attach to flange first, close doors and mark hole to house Cane Bolt Rod. Open doors and drill hole where previously marked with 1/2" bit. Attach with 3/4" Black Screws.

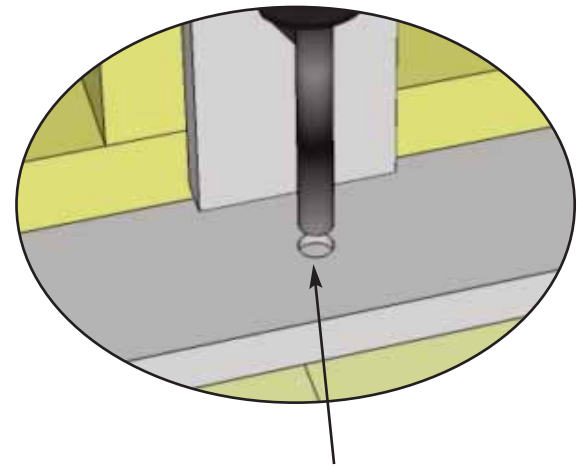

Drill 1/2" Diameter Hole to accommodate rod of Cane Bolt.

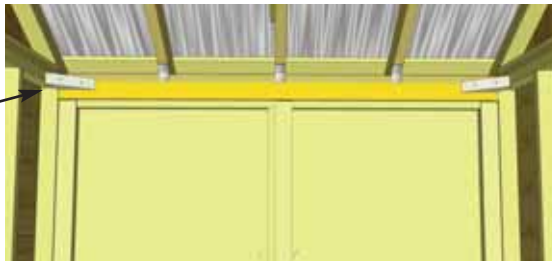
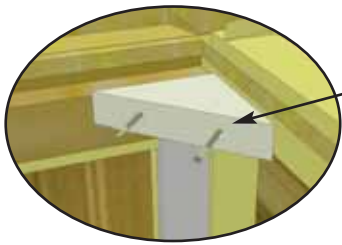

**76.** Attach front **Front Triangular Corner Brackets** - 1 1/2" x 5 1/2" x 5 1/2" (Part 2G) to header and wall frame with 2 - 2 1/2" screws (Part B) per piece.

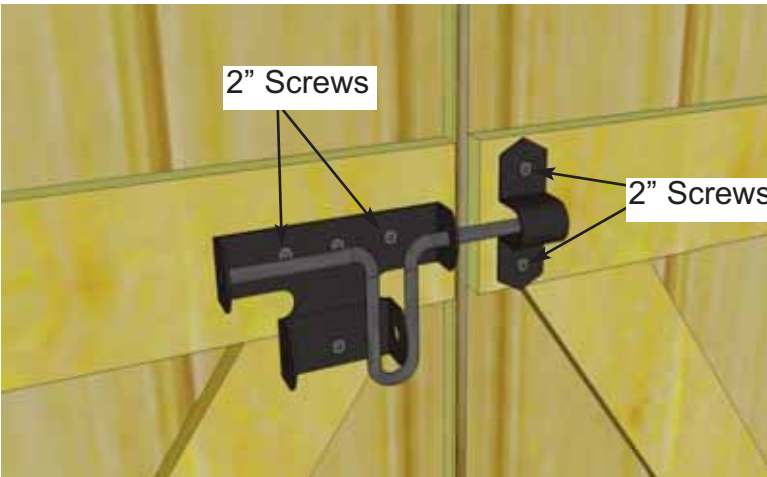

**Important** - Drill pilot holes with 1/8" drill bit prior to securing with screws to prevent wood splitting. On 3/4" screw, drill shallow pilot hole only.

**77.** Attach Black Drop Latch as illustrated above with 2" & 3/4" Black Screws. Note how female part of Drop Latch is positioned higher than male. Do a dry run first to position Drop Latch correctly. **Important** - Drill a shallow pilot hole with 1/8" drill bit prior to securing with screws to prevent wood splitting.



**78.** Attach **Door Handles**. Handles are positioned on top section of each door and mounted with 3/4" Black Screws.



## Congratulations on assembling your 6x6 Maximizer Storage Shed!

**Note;** Our Sheds are shipped as an unfinished product. If exposed to the elements, the western red cedar lumber will weather to a silvery-gray color. If you prefer to keep the cedar lumber looking closer to the original color, we suggest that you treat the wood with a good oil base wood stain. You may also wish to paint your new shed rather than stain it. In both cases we recommend that you consult with a paint and stain dealer in your area for their recommendations.



We hope your experience assembling your 6x6 Maximizer Storage Shed has been both positive and rewarding.

We value your feedback and would like to hear back from you on how well we are doing in the following areas:

1. Customer Service
2. On Time Shipping
3. Motor Freight Delivery
4. Quality of Materials
5. Assembly Manual
6. Overall Satisfaction.

Please call, write or email us at:

Outdoor Living Today

Canadian Address  
9393 287th Street  
Maple Ridge, British Columbia  
Canada V2W 1L1

United States Address  
P.O. Box 96  
Sumas, Washington  
USA 98295



The materials contained in this Assembly Manual may be downloaded or copied provided that ALL copies retain the copyright and any other proprietary notices contained on the materials. No material may be modified, edited or taken out of context such that its use creates a false or misleading statement or impression as to the positions, statements or actions.