



6x6 Maximizer Storage Shed Assembly Manual T&G with Cedar Roof

Version #1.4
August 30, 2022

Thank you for purchasing a 6x6 Maximizer Storage Shed. Please take the time to identify all the parts prior to assembly.



Safety Points and Other Considerations

Our products are built for use based on proper installation and normal residential use, on level ground. Please follow the instruction manual when building your shed and retain the manual for future maintenance purposes.

Some of the safety and usage measures you may wish to consider include:

- snow load ratings vary by geographical location. If heavy or wet snowfall occurs, it is advisable to sweep the snow off the roof(s).
- if the product is elevated, any structural and building code requirements are solely the customer's responsibility, and should be abided by.
- in high or gusty wind conditions it is advisable to keep the structure securely grounded.
- have a regular maintenance plan to ensure screws, doors, windows and parts are tight.

Customer agrees to hold Outdoor Living Manufacturing Ltd. and any Authorized Dealers free of any liability for improper installation, maintenance and repair.

In the event of a missing or broken piece, simply call the Outdoor Living Today Customer Support Line @ 1-888-658-1658 within 30 days of the delivery of your purchase. It is our commitment to you to courier replacement parts, free of charge, within 10 business days of this notification. Replacement parts will not be provided free of charge after the 30 day grace period.

What to do before my Shed arrives?



- Become familiar with this assembly manual and determine if you can complete the project yourself or will require a professional contractor.



- One helper is recommended to assist in constructing your shed. It generally takes two people over two days to assemble a shed. If you're hiring a contractor, their rate should be in line with that duration of work.



- Clear the construction area and ensure a clear pathway for delivery when the freight company arrives. Remove all debris: roots, grass, rocks, etc.



- Excavate the site. Contact your local utilities company to ensure there are no gas or electric lines buried in the area before digging.

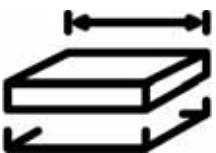

- Decide on the type of foundation you will be using:
 - Concrete slab, or
 - 4-6 inches of crushed gravel with paver stones or 4x4 stringers.

You can find the footprint for your shed on Page 3 of your Assembly Manual.



- If doing the assembly yourself, have all the necessary tools ready to go and in working condition. A list of required tools can be found after the parts list.



Foundation Types for 6x6 Garden Shed

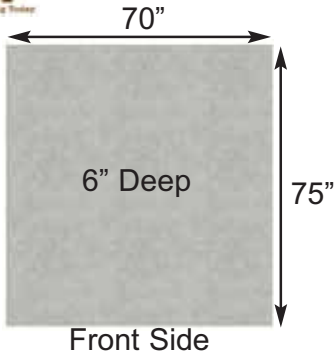

Concrete Foundation

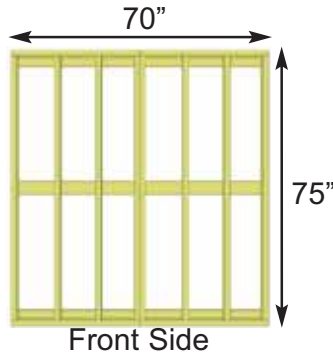

Floor Frame

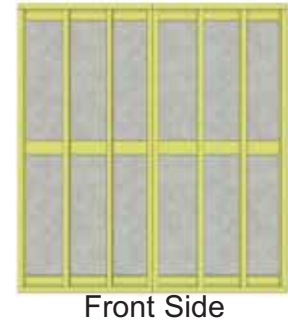

Completed Foundation

Concrete Slab Foundation:

- Slab must be at least the same size as assembled floor frame (70" x 75") or larger.
- 6" Deep foundation.
- 0.7 Cubic Yards of concrete required.
- A concrete slab will have the longest durability out of your foundation options.

Once level, a concrete slab is the easiest surface to build on.

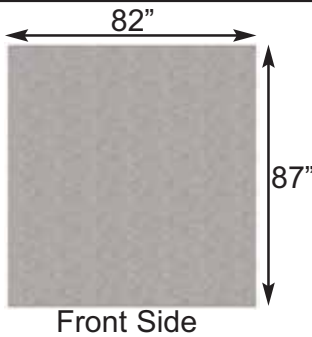

Gravel Foundation

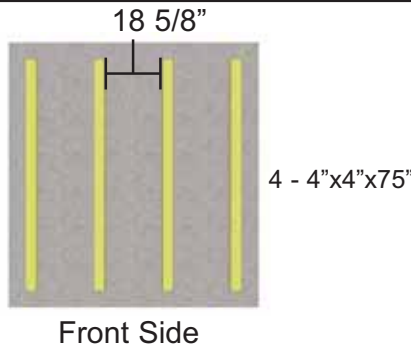

Gravel Foundation with treated stringers

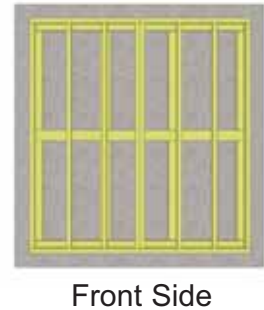

Completed Foundation

Gravel with 4x4 Pressure Treated Stringers:

- Excavate at least 6" deep, and 6" wider than floor frame on each side.
- 1.0 Cubic Yards of gravel required, approximately 9 wheelbarrows.
- 4 - 4x4 Pressure Treated Stringers 75" long required.
- Evenly spaced, with one at each end of floor frame.

Saves money on materials, easy to level and work with.

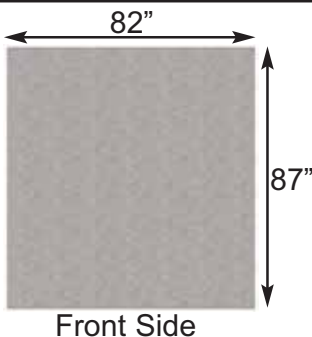

Gravel Foundation

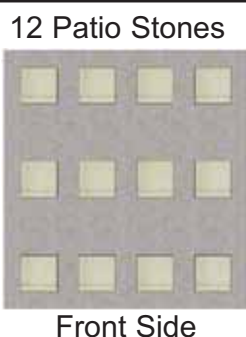

Gravel Foundation with Patio Pavers

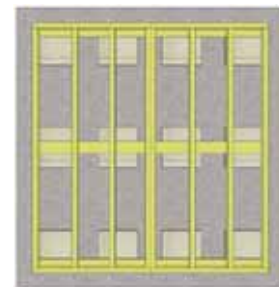

Completed Foundation

Gravel with Patio Paver Stones:

- Excavate at least 6" deep, and 6" wider than floor frame on each side.
- 1.0 Cubic Yards of gravel required, approximately 9 wheelbarrows.
- 12 patio pavers (8" x 8" or larger).
- Center patio paver stones underneath floor runners and underneath seams in floor joists.

Patio paver stones are widely available from most landscape stores.

**Thank you for purchasing a 6x6 Maximizer Storage Shed
Please take the time to identify all the parts prior to assembly.**

Parts List:

1. Floor Section

- 2 - 35" x 75" - Floor Frames - **1A**
- 4 - 1 1/2" x 3 1/2" x 72" - Floor Joists - **1B**
- 3 - 1 1/2" x 3 1/2" x 70" Floor Runners - **1C**
- 2 - 5/8" x 34 7/8" x 74 7/8" - Plywood Floor - **1D**

2. Wall Section

- 6 - 35" x 75" - Wall Panels - (Walls with Bottom Plates Unattached) - **2A**
- 6 - 1 1/2" x 2 1/2" x 35" - Bottom Wall Plates - **2B**

Door Jambs & Header

- 2 - 2 1/2" x 3 5/8" x 73" - Vertical Door Jamb with Cleat attached - **2C**
- 1 - 2" x 2 1/2" x 71 1/4" - Door Header - **2D**

Top Wall Plates

- 2 - 3/4" x 2 1/2" x 75" - Side Top Plates (Angle cut on ends) - **2E**
- 2 - 3/4" x 2 1/4" x 65" - Front & Rear Top Plates (Angle cut on 1 edge) - **2F**
- 2 - 1 1/2" x 5 1/2" x 5 1/2" Front Triangular Corner Brackets - **2G**

Gable Walls

- 2 - Gable Walls - Triangular Shaped - **2H**

Misc. Wall

- 1 pc - Spare Wall Siding - **2I**

3. Rafter and Roof Section

- 12 - 1 1/2" x 3 1/2" x 45" - Roof Rafters with angled ends - **3A**
- 2 - 3/4" x 4 1/2" x 70" - Roof Ridge Boards - **3B**
- 2 - 1/2" x 4 1/2" x 70" - Soffits - **3C**
- 1 - 3/4" x 3 1/2" x 48" - Roof Gusset - **3D**
- 2 - Left Roof Panels - 40 1/2" x 47 7/8" (Shingles overhanging plywood on left side) - **3E**
- 2 - Right Roof Panels - 40 1/2" x 47 7/8" (Shingles overhanging plywood on right side) - **3F**
- 4 - Roof/Facia Cleats - 3/4" x 1 1/2" x 42" - **3G**
- 6 - Long Roof Filler Shingles - **3H**
- 2 - Short Roof Filler Shingles - **3I**
- 12 - Roof Ridge Caps - **3J**

4. Miscellaneous Trim Section

- 2 - 3/4" x 4 1/8" x 79" - Door Trim - **4A**
- 1 - 3/4" x 4 1/2" x 64" - Front Bottom Skirting - **4B**
- 6 - 1/2" x 4 1/2" x 34 3/4" - Side and Rear Bottom Skirting - **4C**
- 2 - 5/8" x 2 1/2" x 75" - Rear Filler Trim - **4D**
- 2 - 1/2" x 4 1/2" x 77 1/2" - Side Rear Wide Trim - **4E**
- 3 - 1/2" x 2 1/2" x 79" - Narrow Trim (Rear Wall) - **4F**
- 2 - 1/2" x 4 1/2" x 77 1/2" - Side Front Wide Trim - **4G**
- 4 - 1/2" x 4 1/2" x 37 3/4" - Horizontal Gable Trim - **4H**
- 2 - 1/2" x 2 1/2" x 77 1/2" - Narrow Trim (Side Walls) - **4I**
- 2 - Horizontal Gable Detail Plates - **4J**
- 4 - 3/4" x 3 1/2" x 46" - Side Facia - Angle cut both ends - (2 right / 2 left) - **4K**
- 2 - 3/4" x 3 1/2" x 79 1/2" - Front and Rear Facia - **4L**
- 2 - Pentagon Facia Plate - **4M**
- 1 - Left Side Door - **4N**
- 1 - Right Side Door - **4O**
- 2 - Cedar Shingles used for Shims - **4P**
- 1 - 1/2" x 1 1/4" x 64" - Above Door Trim - **4Q**
- 1 - 1 1/2" x 2 1/2" x 64" - Horizontal Door Stop with Dado cut - **4R**
- 1 - 3/4" x 2 1/2" x 62 1/2" - Door Threshold - **4S**
- 1 - 1/2" x 2 1/2" x 71" - Interior Door Flange - **4T**
- 2 - 1/2" x 2 1/2" x 71" - Interior Door Stops - **4U**

*** Note - Trim pieces are graded best face on the rough side. Use this side out.**

6 x 6 Maximizer HARDWARE PACKAGE

Screws and Nails

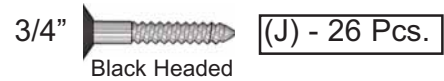
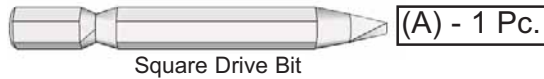

Individual Hardware Components (not actual size)



Door Handle (K) - 2 Pcs.



Exterior Drop Latch (L) - 1 Pc.



Tee Hinge (H) - 6 Pcs.



Cane Bolt (M) - 1 Pc.



Single Rafter Bracket x 4



Double Rafter Bracket x 2

Tools Required



Hammer



Screw Gun/Drill



Tape Measure



Wood Clamp



Level



Pliers



Ladder



1/8" & 1/2" Drill Bits

Safety Equipment Required



Safety Glasses



Work Gloves

Regular Maintenance & Tips to prolong the life of your shed.

Before/During Assembly:

- 1.) Paint each face and edge of your plywood floor with a latex exterior paint.
- 2.) Caulk wall seams if gaps appear.
- 3.) Caulk around window framing.
- 4.) Caulk perimeter between floor plywood and bottom wall plate.
- 5.) Caulk channels in lap siding at the top of your door above the trim, just a drop in each channel.
- 6.) Caulk edge of door threshold (if applicable).
- 7.) Optional: Install a Sill Gasket between floor runners and foundation.
- 8.) Optional: Install an 8" strip of roofing paper below Cedar Ridge Caps for Cedar Roof Sheds.

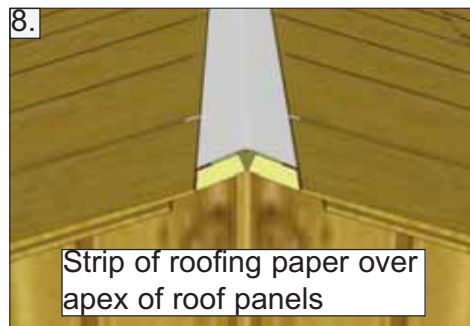
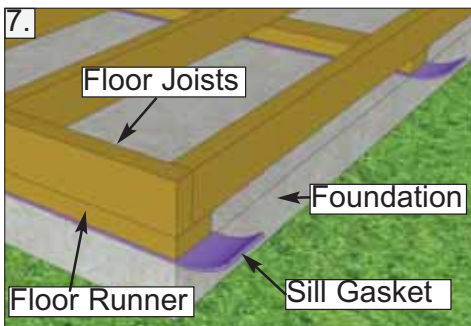
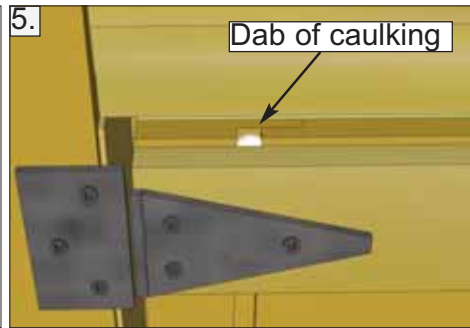
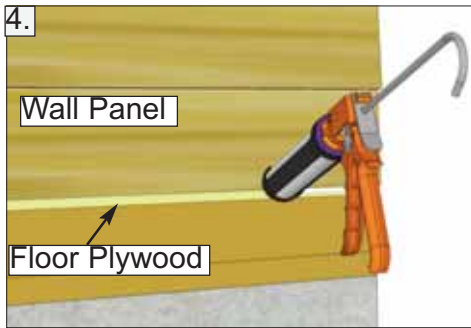
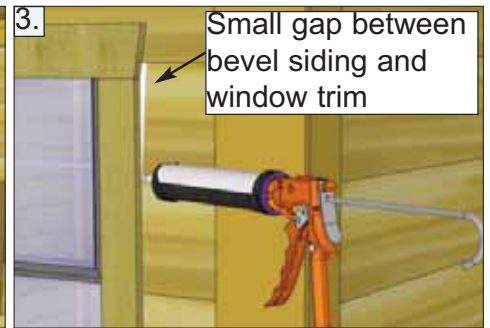
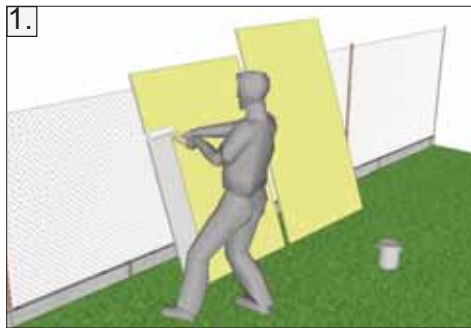

Routine Maintenance:

- Routinely check all fasteners are tight (ex. Door Hinges, Nails)
- Brush off dirt from walls.
- Brush off snow from roof regularly.
- Routinely remove needles and leaves from roof.

Painting/Staining

- Your cedar shed, if left untreated, will weather to a silvery grey colour.
- Painting or staining your structure is highly recommended and will prolong the life of your shed.
- You do not need to wait to paint or stain your shed, the wood in your kit has been dried and can be stained or painted immediately.
- Consult your local paint store for the best paint or stain for cedar.
- Optional: stain the inside of your shed. (Note: this will remove the fresh cedar smell.)

A. Floor Section

Exploded view of all parts necessary to complete Floor Section. Identify all parts prior to starting.

Note, Floor Footprint is 70" wide x 75" deep.

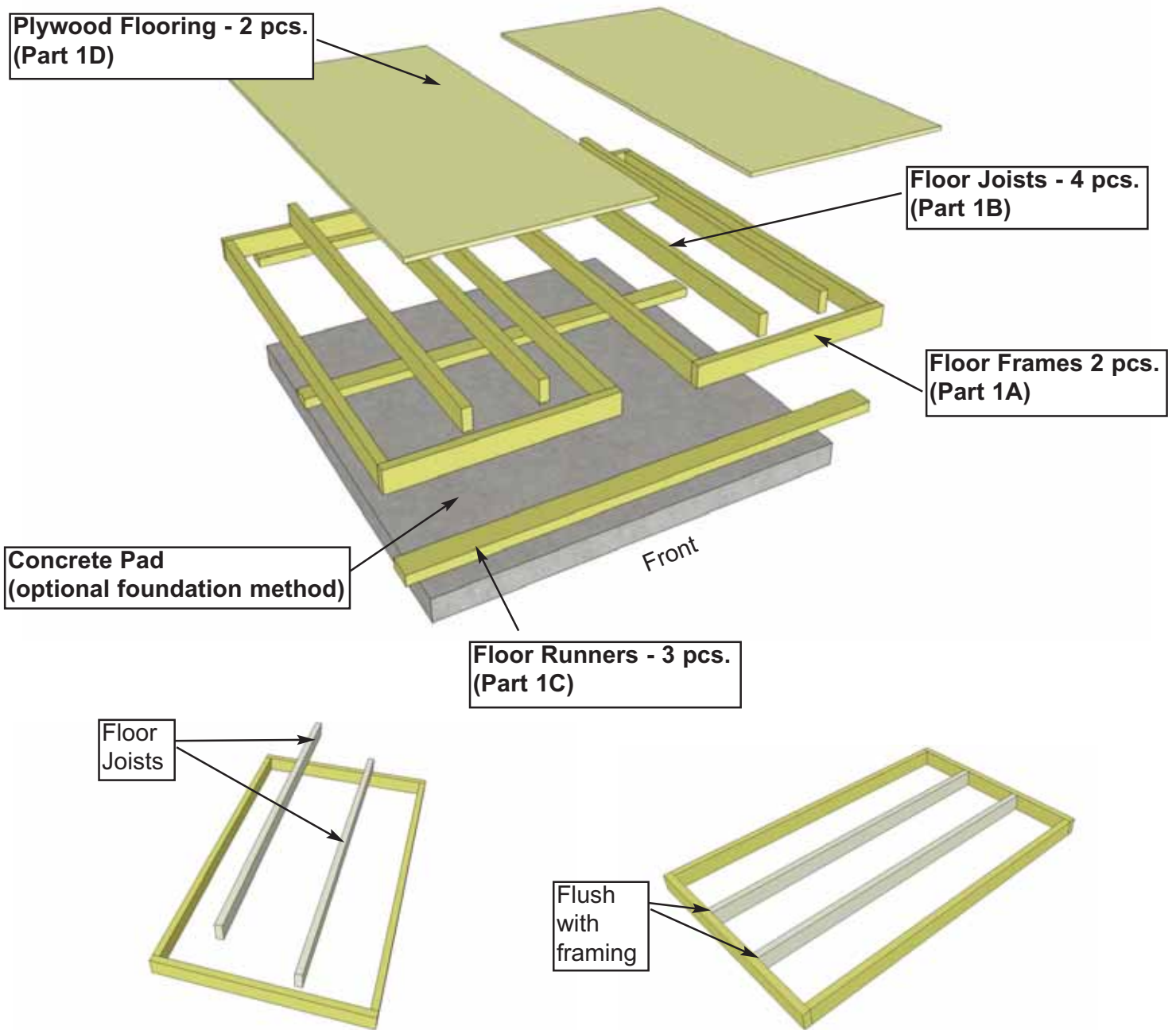

1. Lay out one Floor Frame Section (Part 1A) and Floor Joists 2 @ 1 1/2" x 3 1/2" x 72" (Part 1B) as illustrated above. Space joists equally in floor frame section flush with framing.

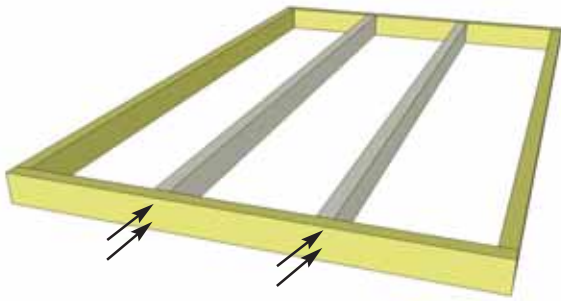

You can find the Square Drive Bit (Part A) for the screws in with the Hardware Kit Bag.

2. When correctly positioned, attach each joist with **4 - 2 1/2" screws (Part B)** - 2 per end. Complete Joist attachments for 2nd Floor Frame.

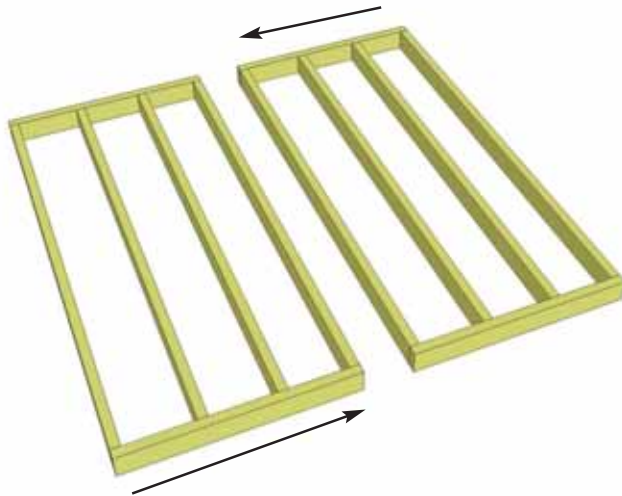

3. Lay out both completed **Floor Frames** as illustrated.

4. Align Floor Frames together as shown below. Screw sections together with **8 - 2 1/2" screws (Part B)**. Alternate screw location. Use a wood clamp to keep frames together while screwing.

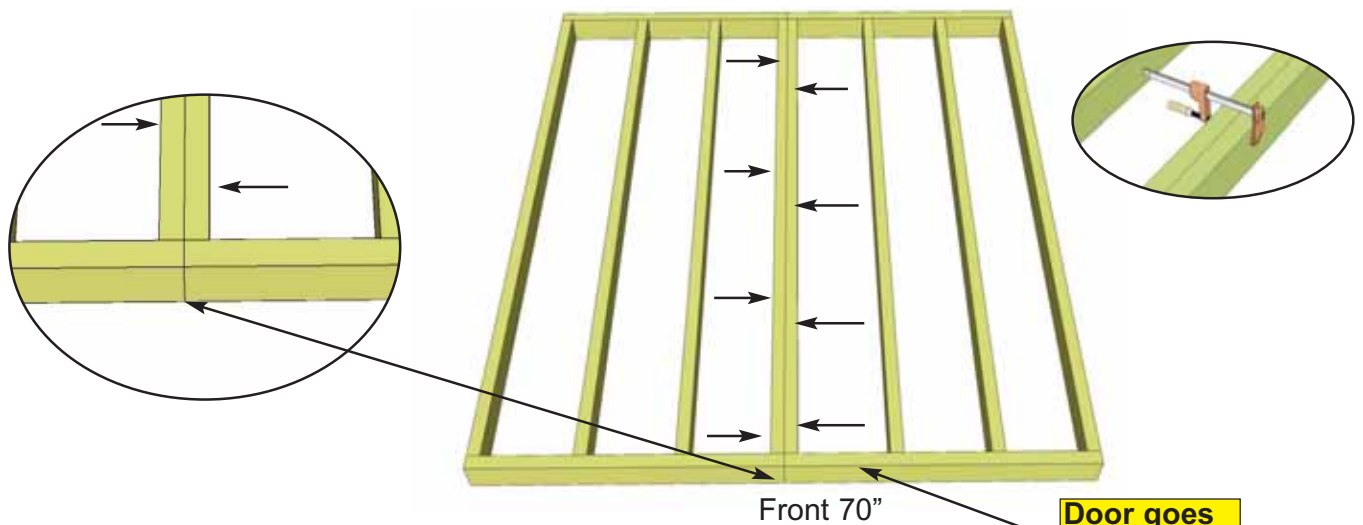

5. When completed, your floor footprint should be **70" wide x 75" deep**.

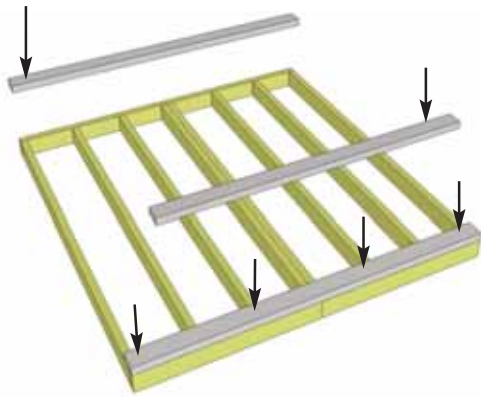

6. Attach **Floor Runners 3 @ 1 1/2" x 3 1/2" x 70"** (Part 1C) to completed floor frames. There are 3 floor runners per 70" side. Use **8 - 2 1/2" Screws (Part B)** per runner.

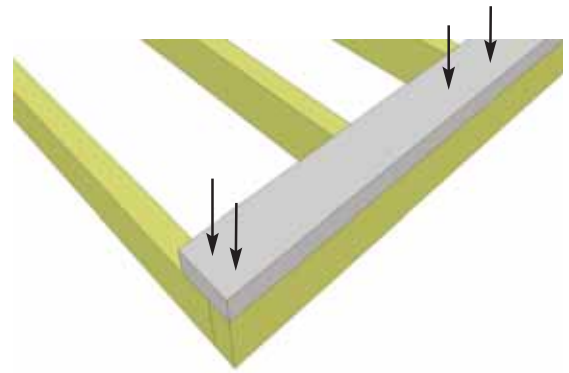

7. Make sure runners are flush with outside and front and rear floor framing but not overhanging.

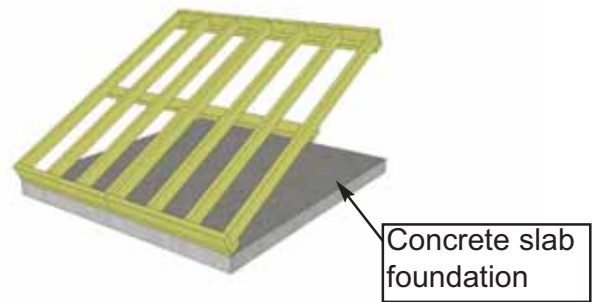
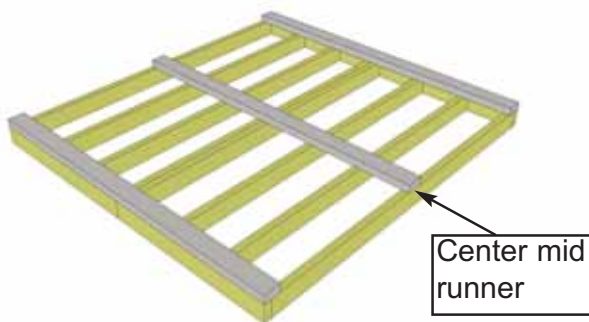

8. Complete all floor runner attachments.

Foundations

Note: The floor will be flipped over and floor runners will sit on your foundation. It is important to note that having a level foundation is critical. Choosing a foundation will vary between regions. Typical foundations can be concrete pads or patio stones positioned underneath the floor runners.

9. With floor runners attached, carefully flip the floor over and place on your foundation. **Caution-** you will need 2 people to assist you. Be careful when laying floor down not to bend or twist floor. When in place, level floor completely. **Measure diagonal** in both directions to confirm square. Both should be approximately 102 1/2". Adjust floor if necessary.

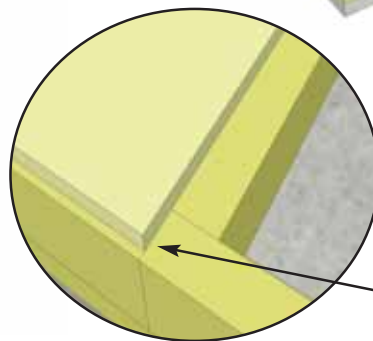
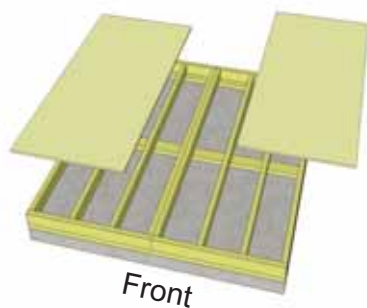
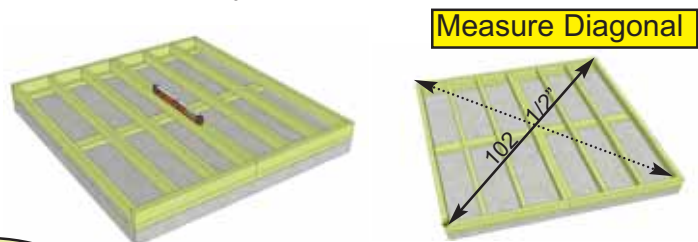

10. Position **Plywood Floors - 2 pcs (Part 1D)** on top of completed floor frames as shown above. The plywood is cut slightly smaller than floor framing. Align so plywood seam is tight.

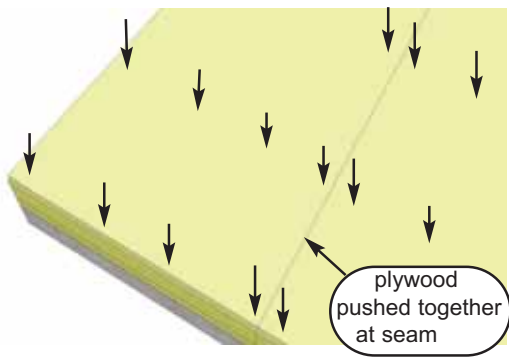

11. With Plywood positioned correctly on floor framing, attach using **16 - 1 1/4" screws (Part C)** per sheet.

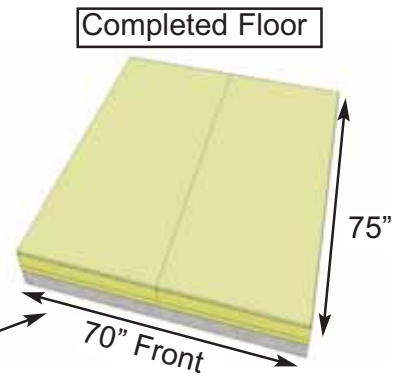

2. Wall Section

Exploded view of all parts necessary to complete the Wall Section. Identify all parts prior to starting.

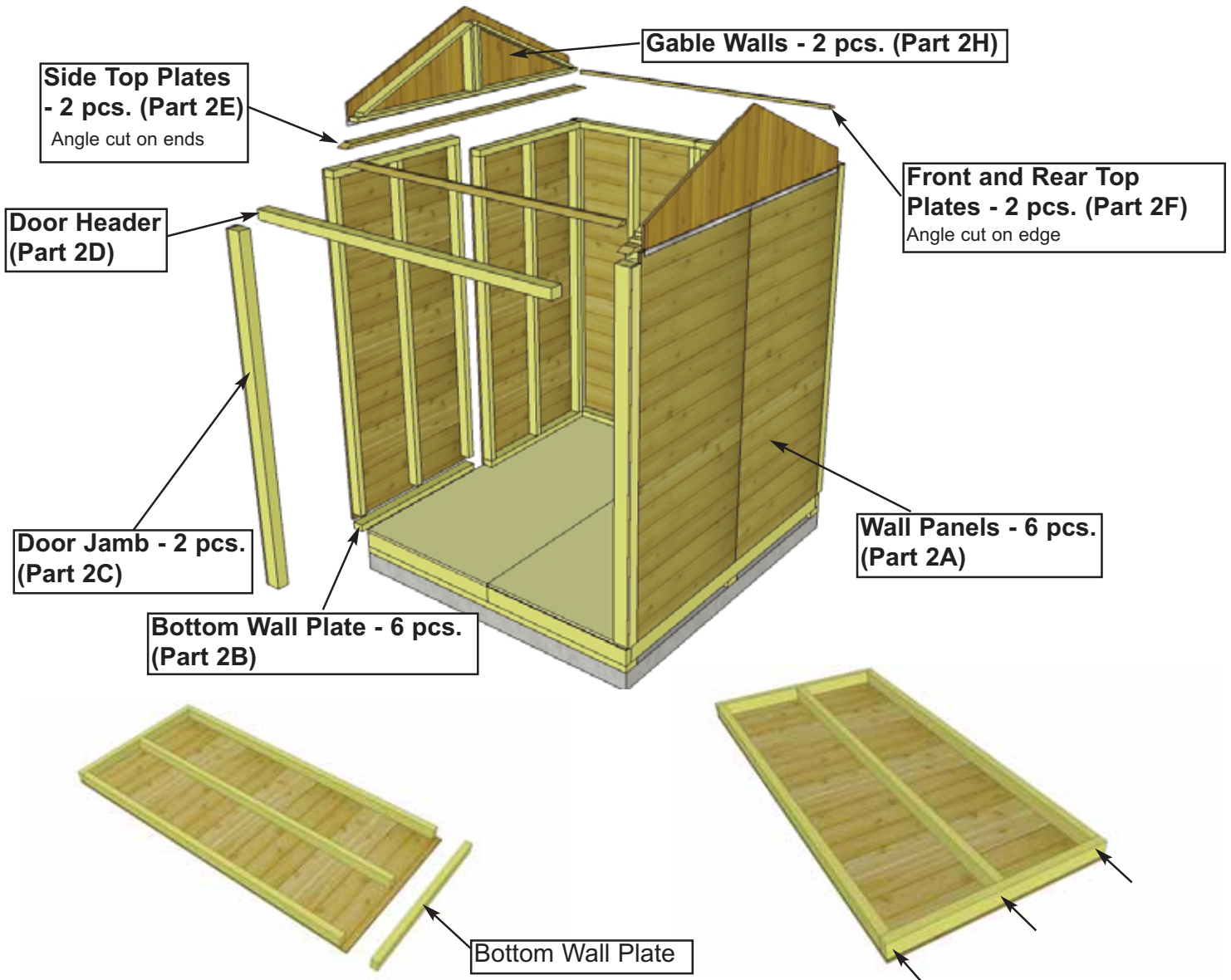

12. Carefully lay a **Wall Panel (Part 2A)** face down. Locate a **Wall Plate - 1 1/2" x 2 1/2" x 35"** (**Part 2B**) and position plate flush with framing and siding. Attach to bottom of wall framing with **3 - 2 1/2" screws (Part B)**. Complete all bottom wall plate attachments for remaining walls at this time.

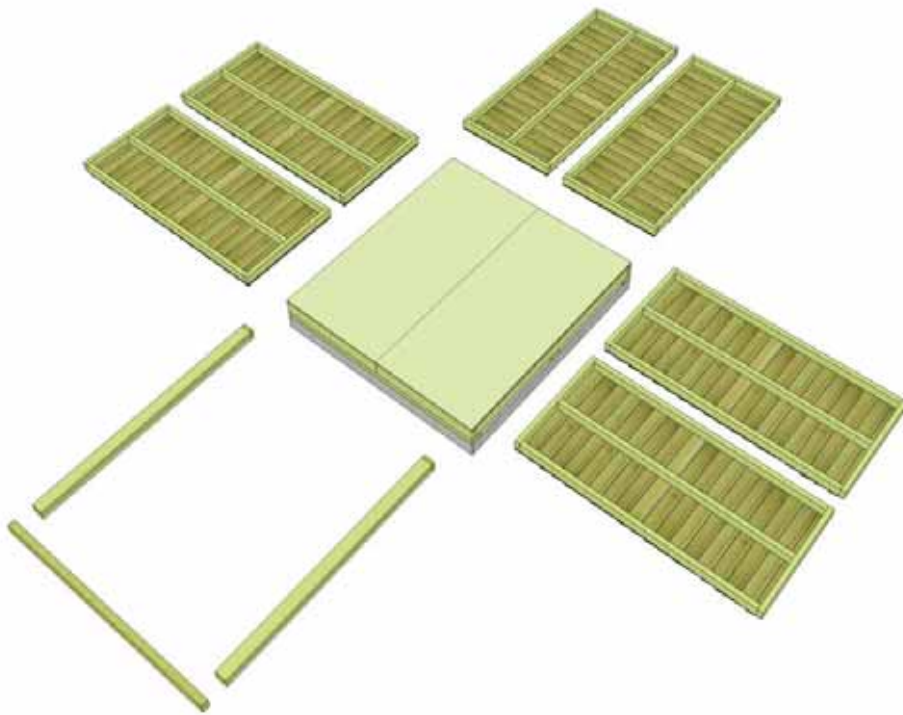

13. Lay out all the wall panels. Make sure to position panels right side up so water is directed away from

1 piece of spare Bevel Wall Siding - 3/4" x 7 1/2" x 35" (Part 21) is included in kit. Please do not dis-

14. Starting at rear corner, position wall panel on top of plywood floor. The wall panel bottom framing will sit flush with floor framing slightly overhanging plywood. The butt of the wall siding will overhang plywood floor.

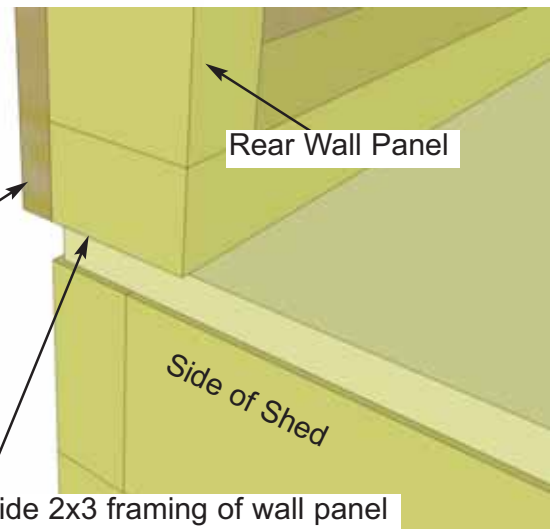
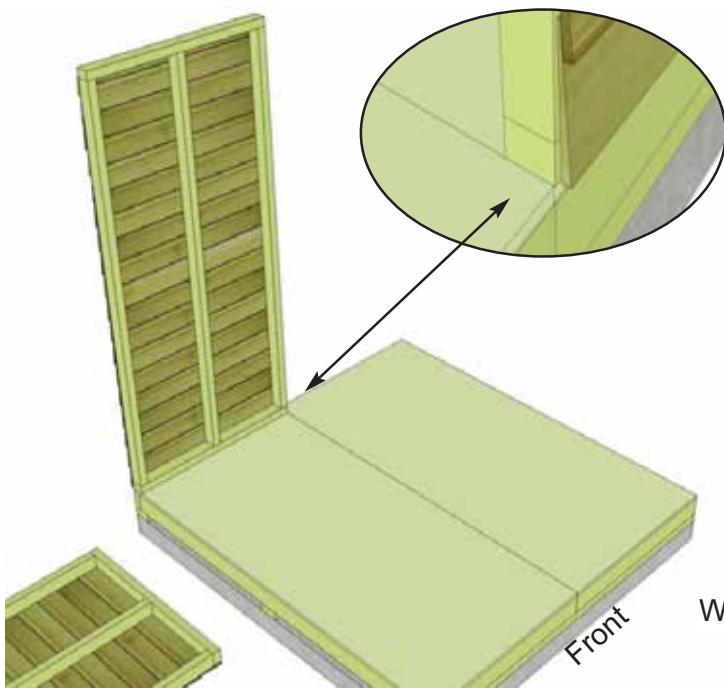

15. The wall panel will sit flush at the end of the plywood floor with the side wall panels sandwiched between them.

Note: Siding will overhang the floor by approx. 5/8"

Outside 2x3 framing of wall panel will sit even with outside of floor framing with plywood flooring slightly inset.



Optional - Caulking seams will help prevent moisture from entering at seam.
Caulking not included in kit.

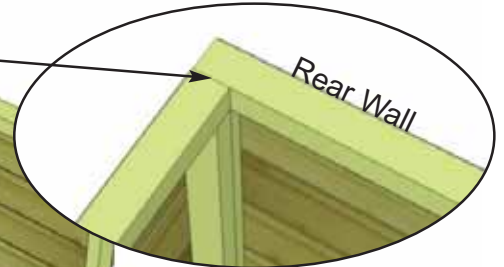
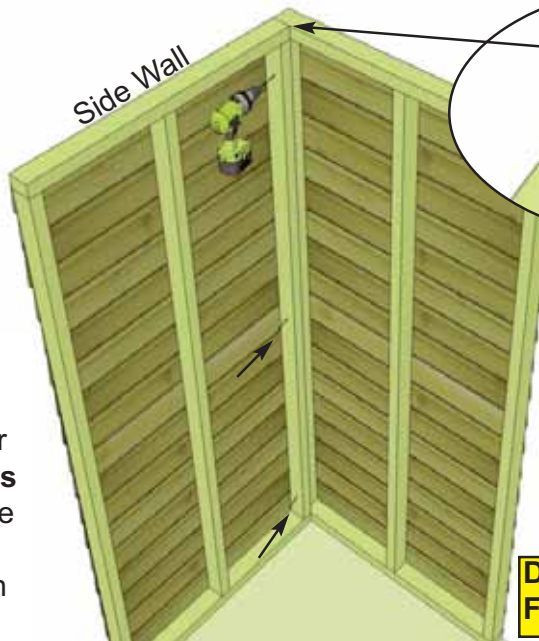
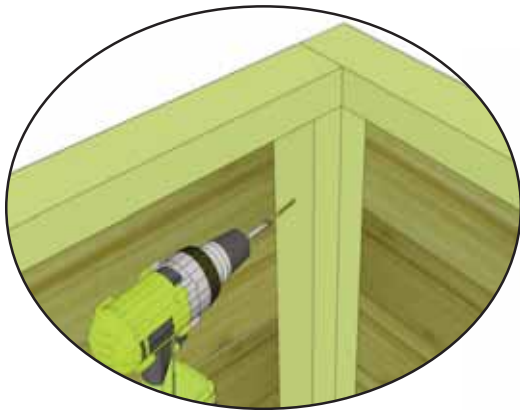
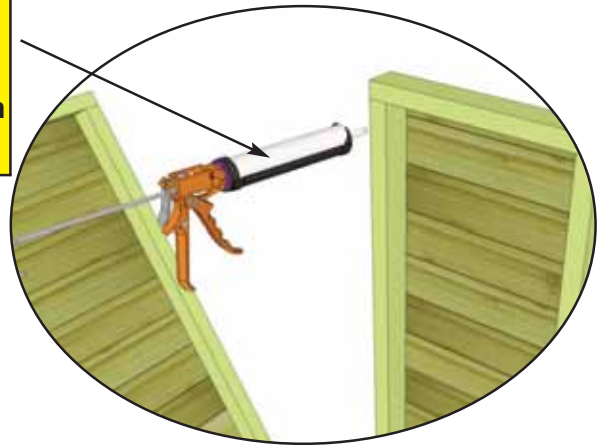

16. Position side wall into place on plywood floor. Butt both vertical wall frames of side and rear walls together tight and attach with **3 - 2 1/2" screws (Part B)**. Start at top and screw in the middle and bottom of framing. Screw on a slight angle into the meat of both frames.

Do Not Attach Walls To Floor until Step 28.

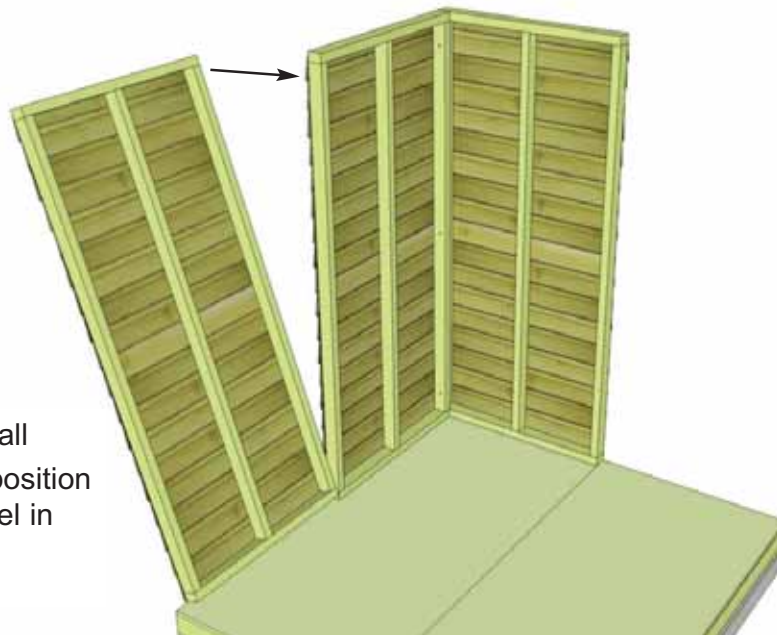

17. With the corner wall attachment complete, position a second side wall panel in place.

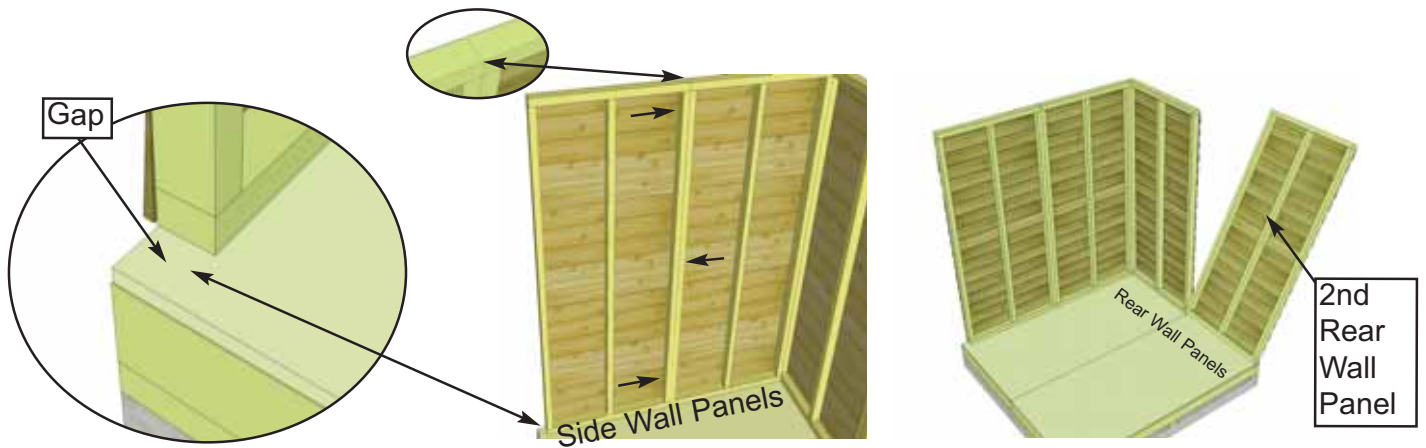

18. Align vertical wall frames of both side wall panels together and attach with **3 - 2 1/2" screws (Part B)**. Locate and position the 2nd rear wall panel into place.

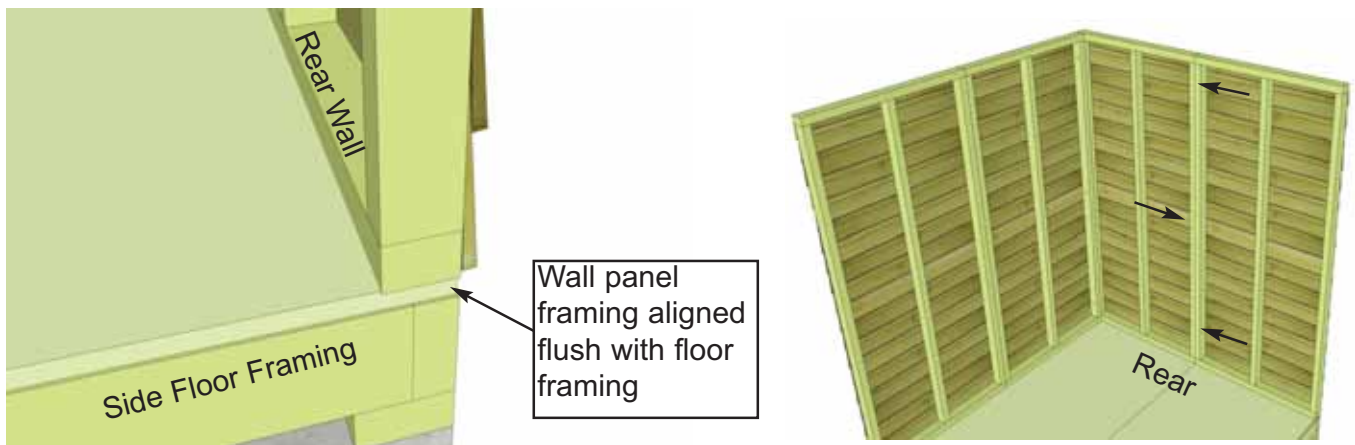

19. Align wall panel framing as per **Step 18**. The wall panel framing with sit flush with floor framing as shown above. Attach vertical wall frames together as per **Step 18**.

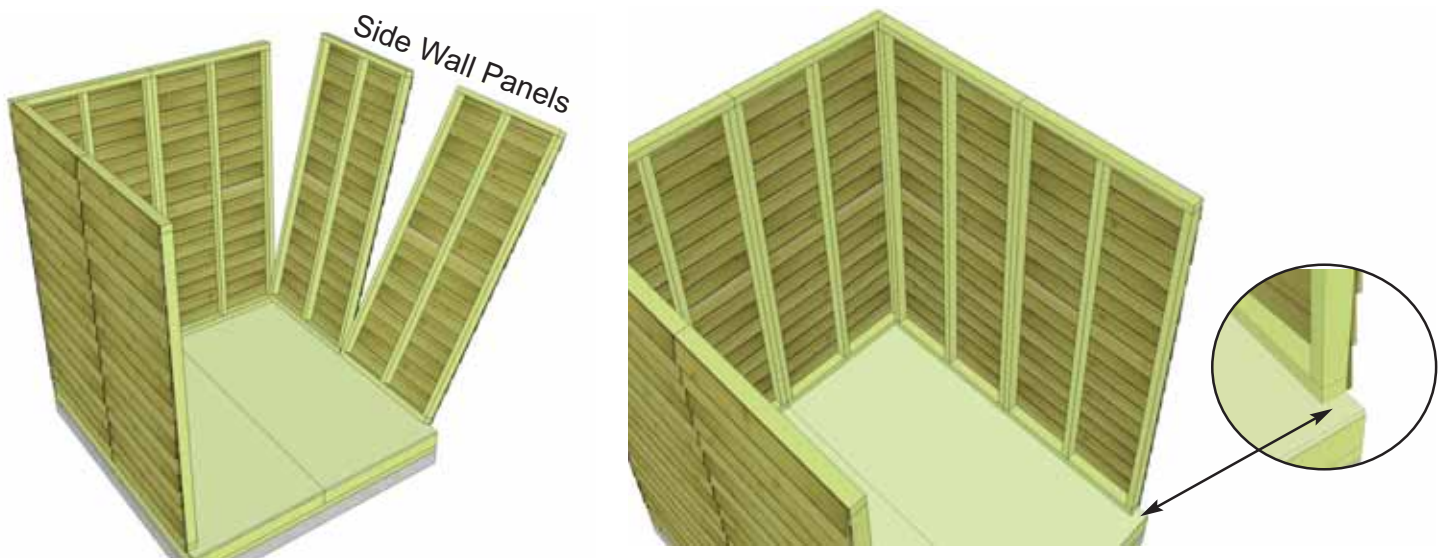

20. Position and attach remaining side wall panels together as per **Steps 16-18**.

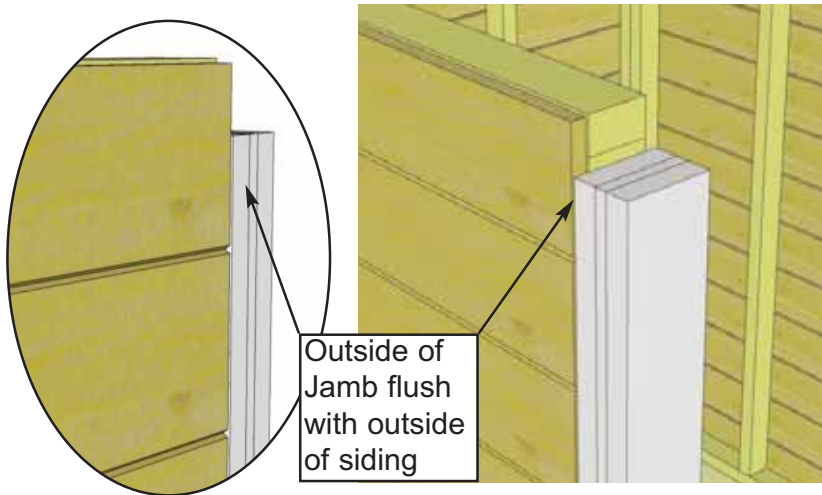

21. Locate Door Jambs. Position outside of Jamb flush with outside of siding. At the floor, Jamb should be flush with floor framing on the front and overhanging floor framing on sides.

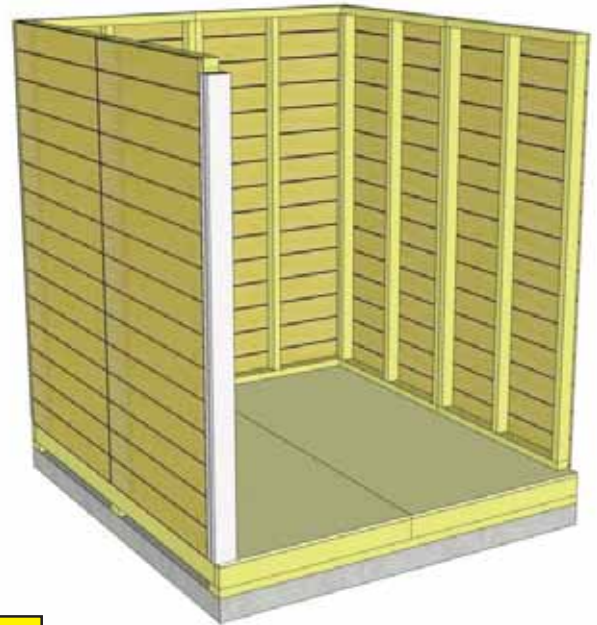

When aligning Jambs and Header in **Steps 21-23**, do a dry run first to confirm spacing. Tack jambs with only a few screws initially. Jambs should be 64" apart when measured inside to inside.

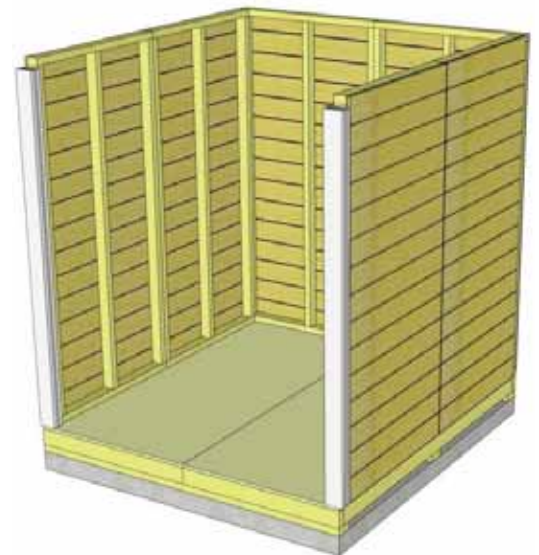
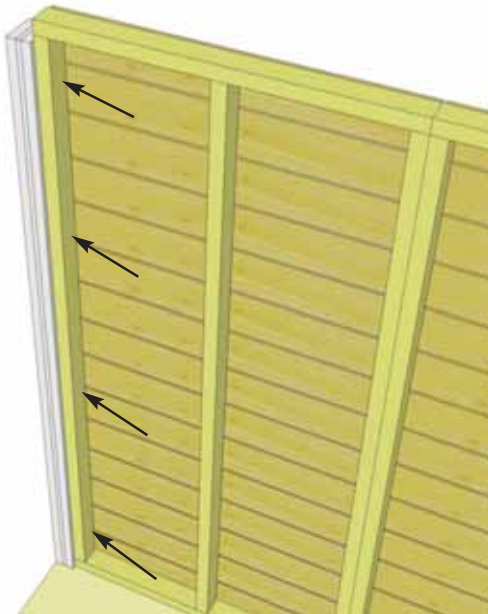

22. Attach Door Jamb to vertical wall stud with 4 - 2 1/2" screws. Complete both Door Jambs.

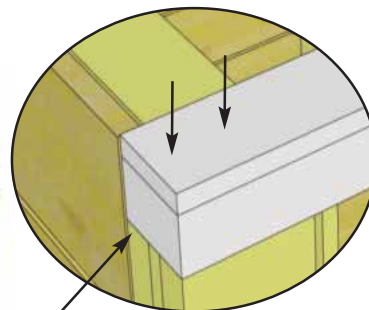
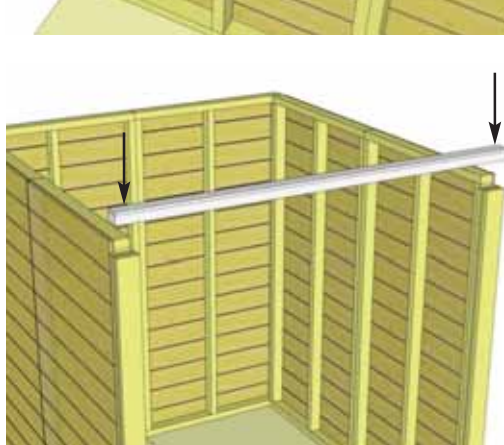

End of Header flush with outside of Door Jamb.



23. Position and attach the Door Header flush to outside end of Door Jamb with 2 - 2 1/2" screws per side. Important- Drill 1/8" pilot holes in end of Door Header to prevent wood from splitting.

On ends, screwing on slight angle provides more strength.

Top Plate aligned flush with inside of wall framing

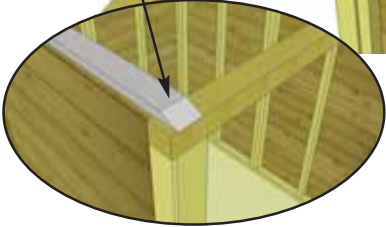
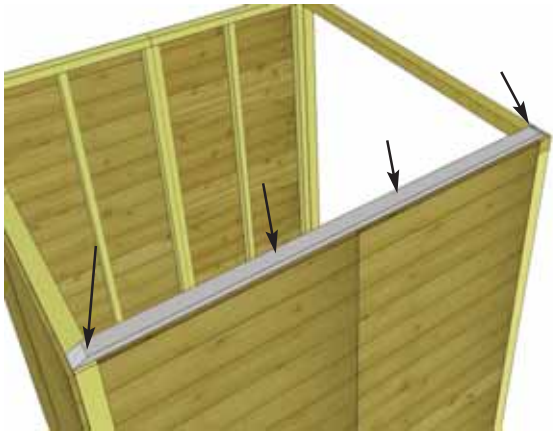

24. Position one **Side Top Plate** (angle cut on both ends) - **3/4" x 2 1/2" x 75"** (**Part 2E**) on top wall framing. Top plate should be evenly spaced from front to back and aligned flush with the inside of top wall framing. Attach to framing with **4 - 2" screws (Part E)**.

25. Position a **Front Top Plate** (angle cut on edge) - **3/4" x 2 1/4" x 65"** (**Part 2F**) on to top of wall framing. Butt the straight cut end up to side top plate and align flush with the inside of door header. See illustrations below. When correctly aligned, attach into header with **4 - 2" screws (Part E)**.

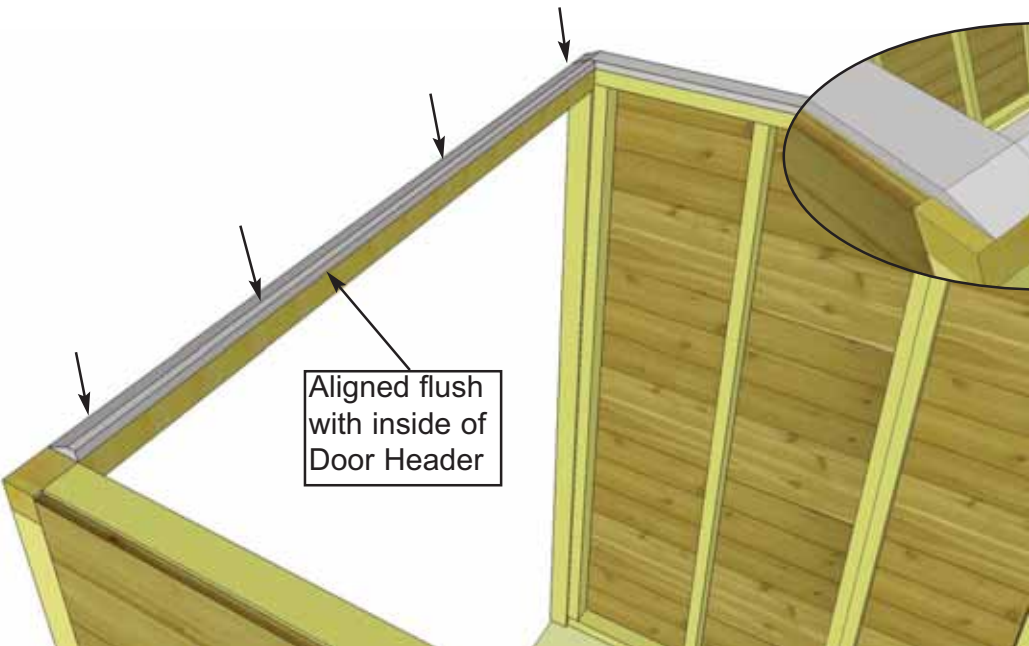

Aligned flush with inside of Door Header

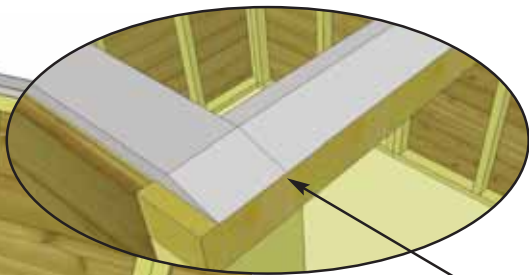

Front Top Plate butted up against Side Top Plate with angled edge to outside

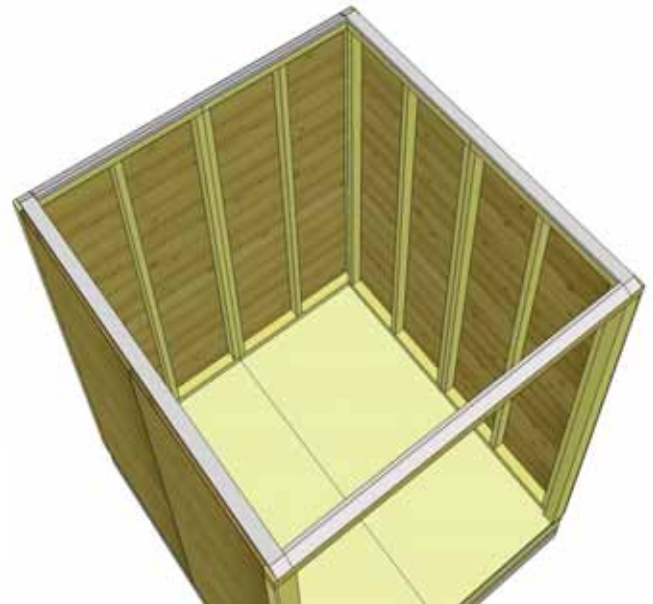

26. Complete remaining Side and Rear Top Plate attachments as per **Steps 24-25**.

Important: Prior to fastening walls and installing rafters, take time to confirm your walls are level, square and plumb. Measure diagonal at top and bottom of walls corner-to-corner. This should be approximately 95 1/2". More importantly, if measurements are not within 1/4", your walls are not square. Adjusting now will make it easier to install the roof section later.

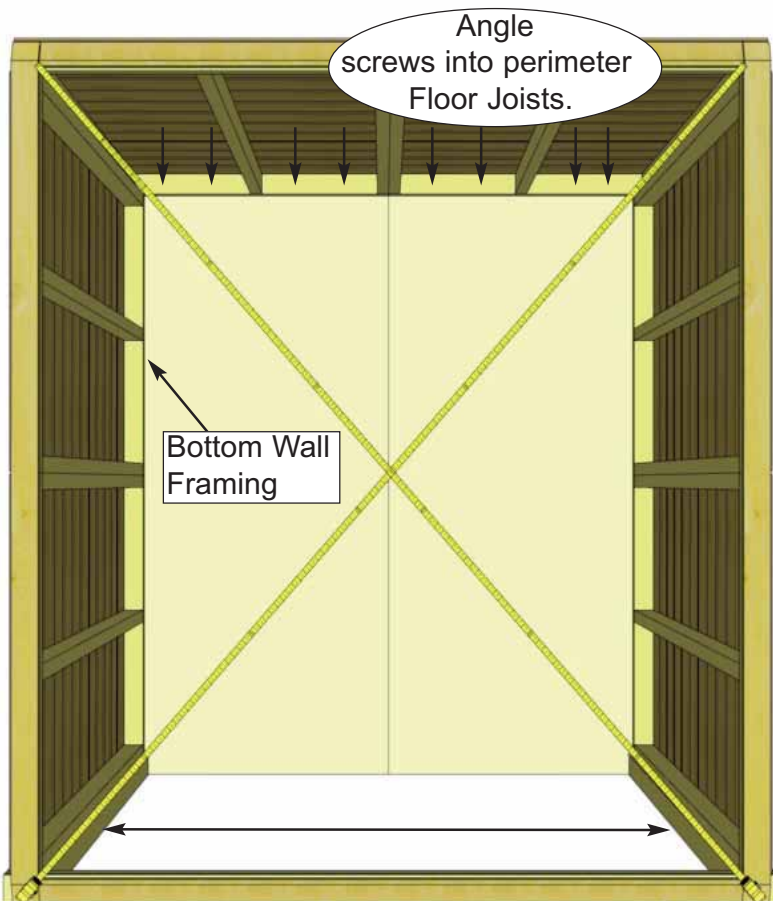

27. When all Walls and Top Plates are attached together, check wall and floor alignment. Bottom wall framing should sit flush with outside of floor joists. See **Steps 15-20** for correct alignment.

Confirm Door Jambs are 64" apart at top and bottom of door opening.

When positioned correctly, fasten bottom wall plates to floor using 4 - 2 1/2" screws per wall panel.

Optional - Caulking seams will help prevent moisture from entering at seam.
Caulking not included in kit.



Confirm 64" Wide between Door Jambs

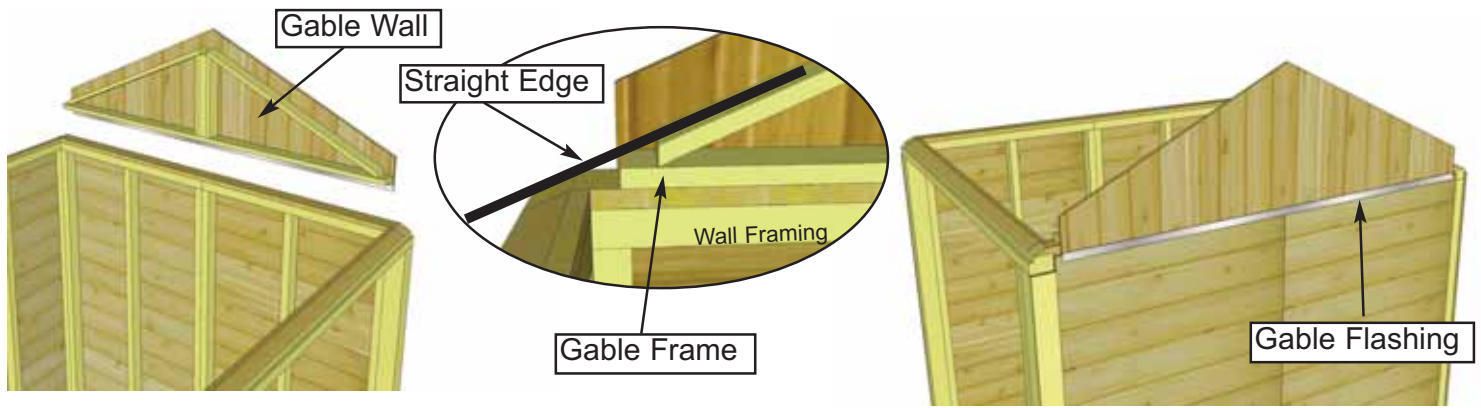

28. Locate and place **Gable Wall (Part 2H)** so gable framing sits flush with the inside of the top plate. Center from front to rear using a Straight Edge to confirm angle of gable frame and Top Plate line up. Adjust gable accordingly. From the outside, make sure gable flashing overhangs wall siding.

Temporarily attach gable walls to top plate. Slight adjustment may be required later



29. Temporarily attach gable walls to top plate with **2 - 2" screws (Part E)**. Screw from the bottom of gable framing down into top plate. Gables may need slight adjustment in **Step 39** and then be completely attached with an additional **6 - 2" screws (Part E)**. Position 2nd Gable on side walls.



30. Position and temporarily attach 2nd Gable as per **Steps 28-29**.

3. Rafter and Roof Section

Exploded view of all parts necessary to complete the Roof Section.
Identify all parts prior to starting.

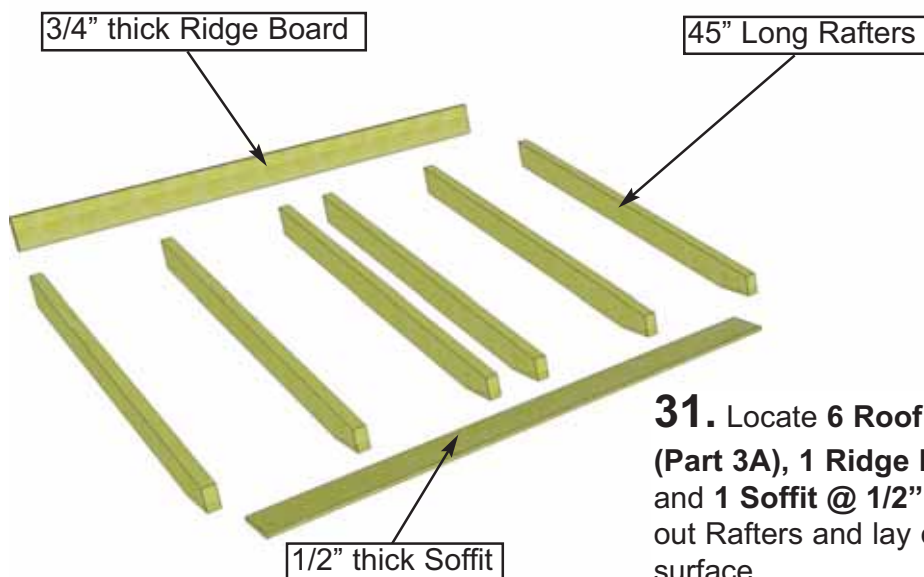
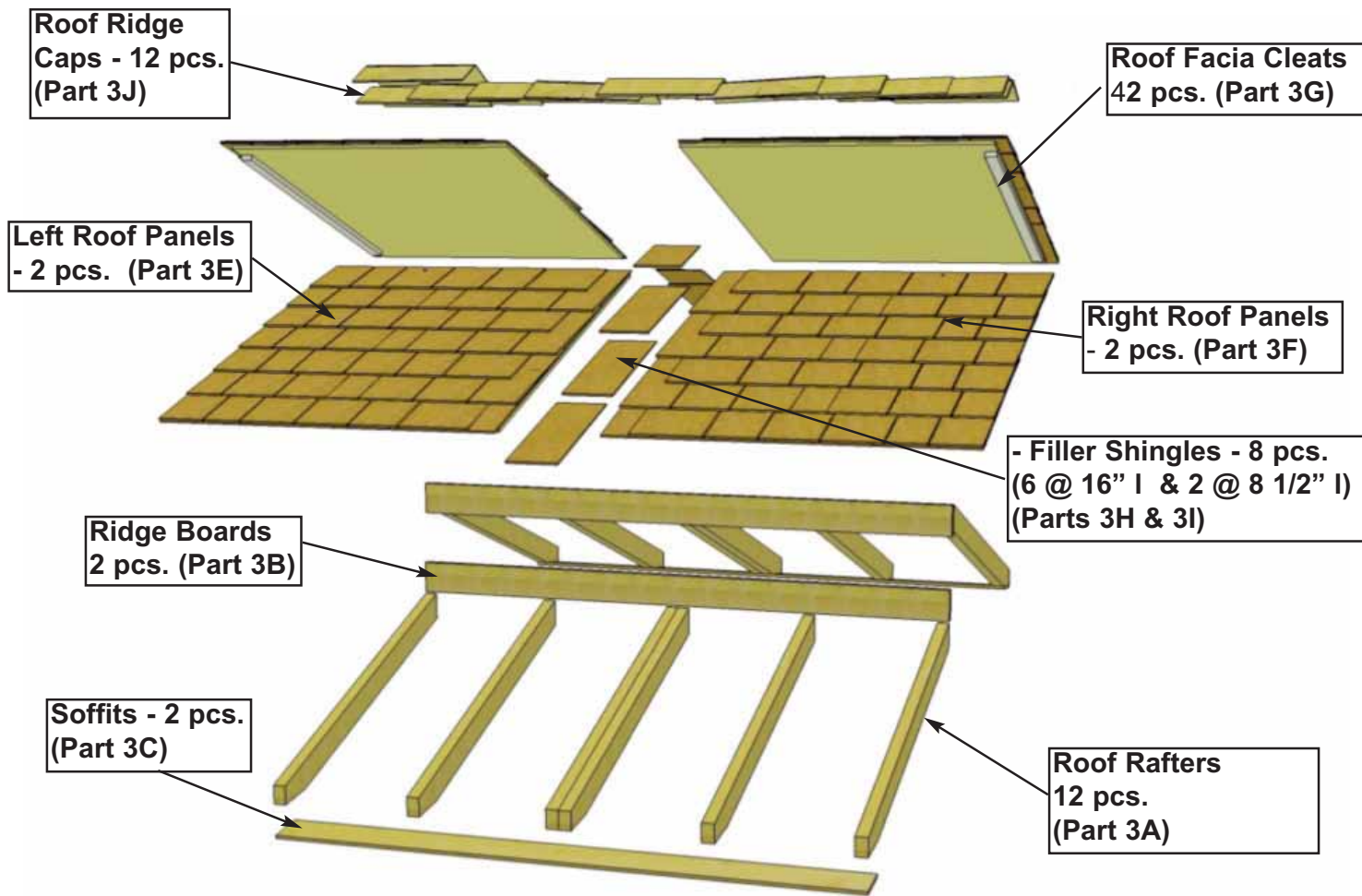

31. Locate 6 Roof Rafters @ 1 1/2" x 3 1/2" x 45" (Part 3A), 1 Ridge Board @ 3/4" x 4 1/2" x 70" (Part 3B) and 1 Soffit @ 1/2" x 4 1/2" x 70" (Part 3C). Evenly space out Rafters and lay out as illustrated to the left on a flat level surface.

32. Attach Ridge Board to ends of both outside rafters with **2 - 2" screws (Part E)** per end. Drill $\frac{1}{8}$ " pilot holes in Ridge Board to prevent splitting. Measure and position interior Rafters as illustrated below. Double up center rafters and screw together with **2 - 2 1/2" screws (Part B)** first. When positioned correctly, attach Ridge Board to remaining rafters with **2 - 2" screws (Part E)** /rafter end.

Important:
Pilot Hole Ridge Board and Soffit prior to screwing to prevent splitting!

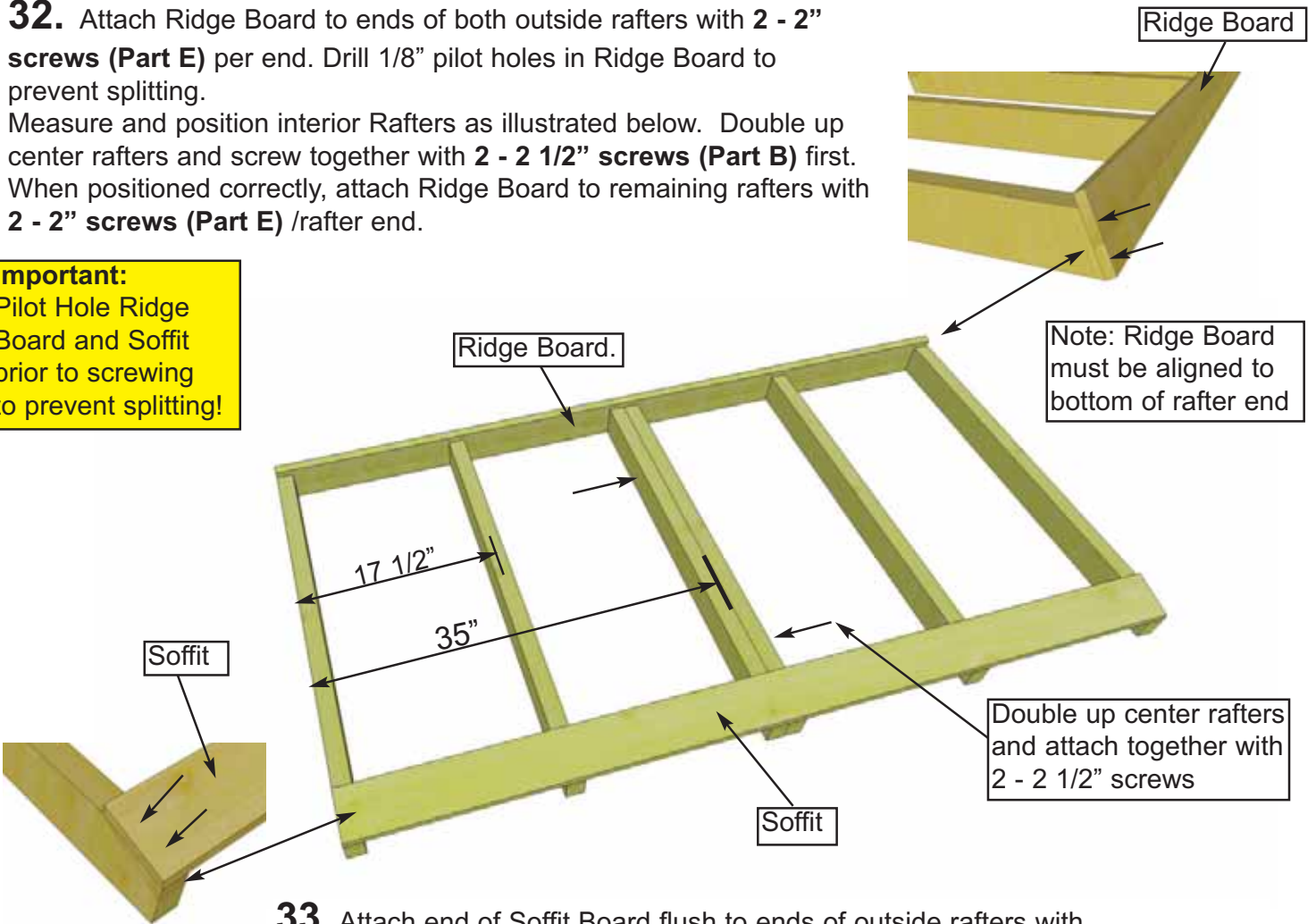

33. Attach end of Soffit Board flush to ends of outside rafters with **2 - 1 1/4" screws (Part C)** per rafter end. **Drill pilot hole in soffit ends to prevent splitting.** Complete both outside rafter / soffit connections first. Measure and position interior rafters as illustrated above. When positioned correctly, attach soffits to remaining rafters with **2 - 1 1/4" screws (Part C)** /rafter.



34. Complete 2nd Rafter section now as per **Steps 32 - 33.**

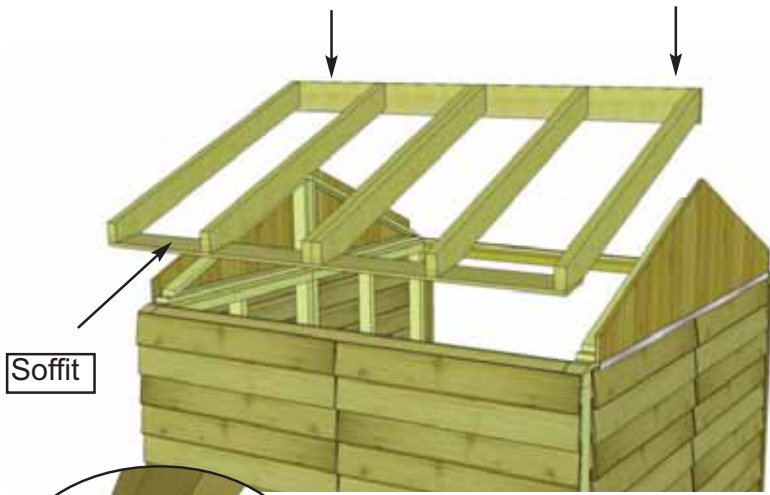

Soffit

35. Starting at the rear and with a helper, flip a completed rafter section over and lift up and place rafter section on gable wall framing.

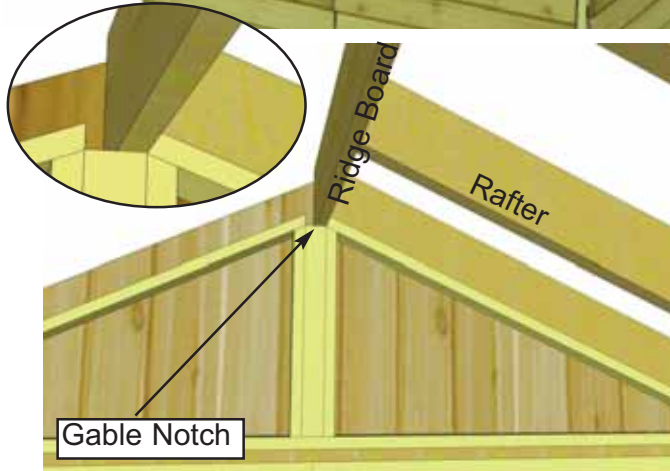

Gable Notch

36. Slide rafter section up on gable framing until bottom of ridge board slips into gable notch.

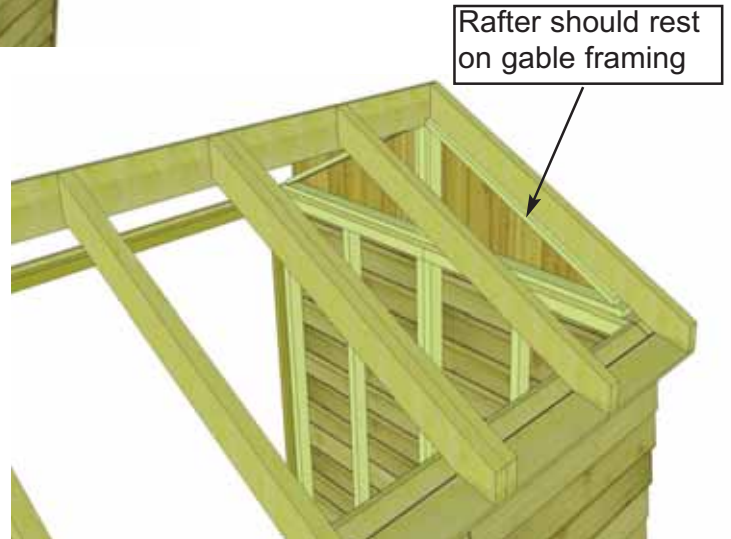

Rafter should rest on gable framing

37. When rafter section is correctly positioned, outside rafters will sit equally on gable framing and soffit will sit approximately 1/8" to 1/4" away from wall panels.

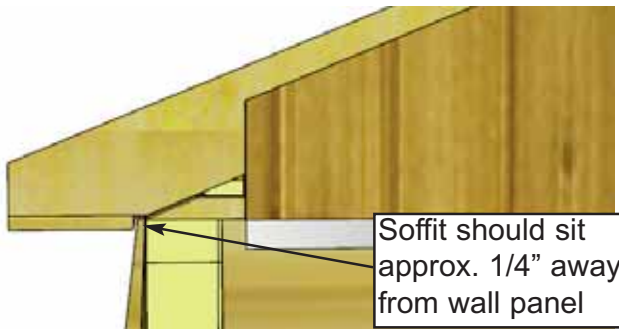

Soffit should sit approx. 1/4" away from wall panel

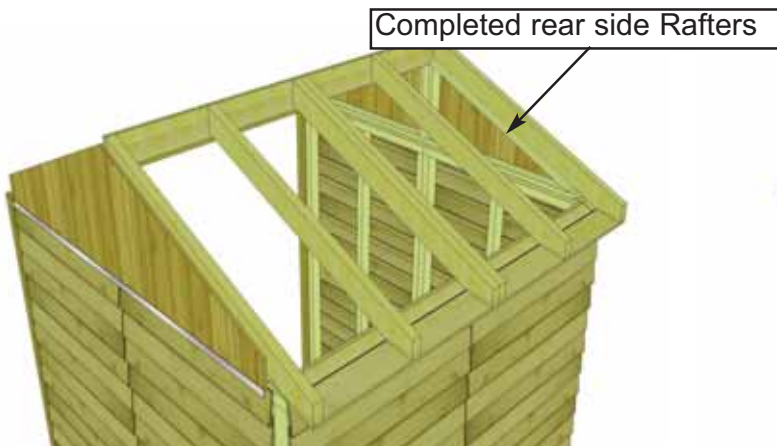

Completed rear side Rafters

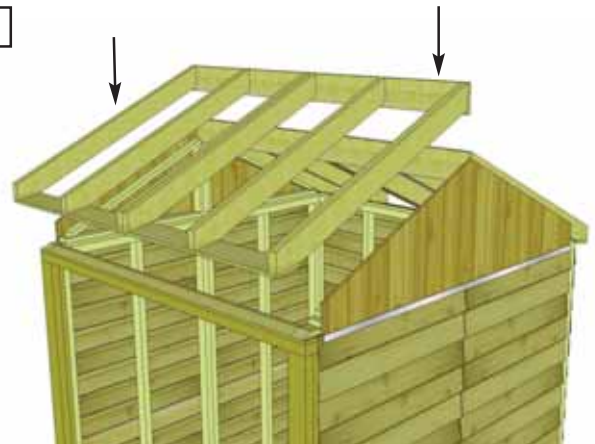

38. Place 2nd completed rafter section on gable wall framing. Position as per **Steps 35 - 37.**

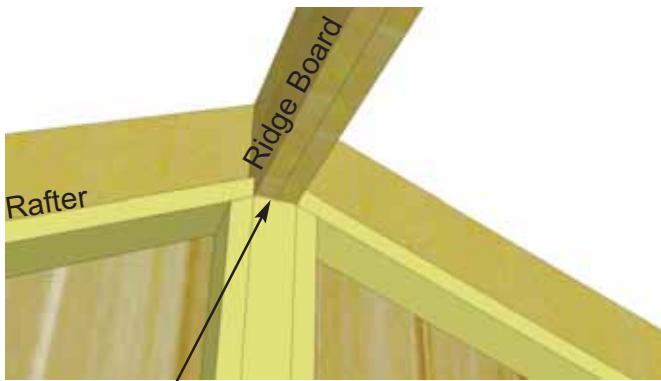

Gable Notch.

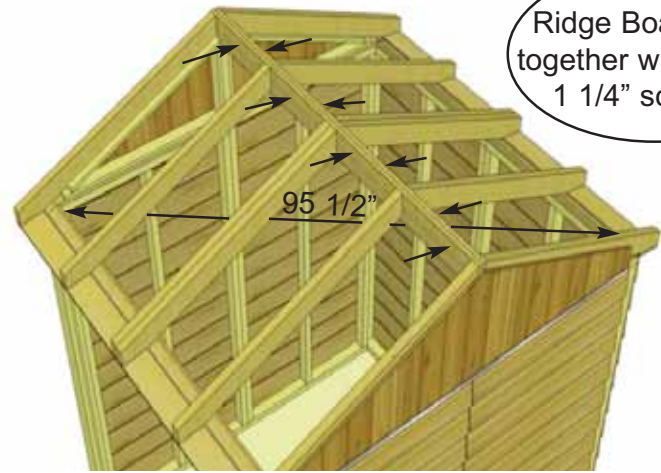

Screw Ridge Boards together with 1 1/4" screws

39. With ridge board locked into gable notch, align ridge boards so they are flush together and secure them with **8 - 1 1/4" screws (Part C)**. **Important** - if there is a gap between Ridge Boards, try pushing rear wall and Door Header closer together from outside. Before moving on with further steps, confirm your shed is square at wall height by checking the diagonal distance of the top walls on the inside. In both directions, the distance should be approximately **95 1/2"** depending on where you measure. It is important that both diagonal measurements are approximately equal. If not, adjust walls until an equal distance is achieved.

40. With both ridge boards connected, completely secure gable wall framing to walls and rafters. Use **3 - 2" screws (Part E)** per Rafter. Use an additional **6 - 2" screws (Part E)** to secure gable to top plate.

Note- you may have to remove the **2 temporary screws in gable wall from Step 29** and reposition gable for best fit prior to completing gable attachment.

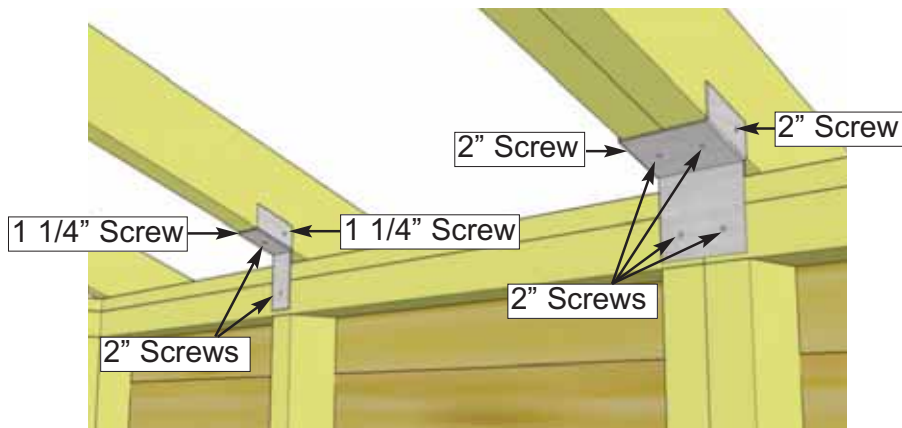

41. Attach all **Single** and **Double Rafter Brackets** where rafters meet **Top Wall Plates** inside of shed. Attach with **2 - 1 1/4" screws** and **2 - 2" screws** per **Single Bracket** and **6 - 2" screws** per **Double Bracket**.

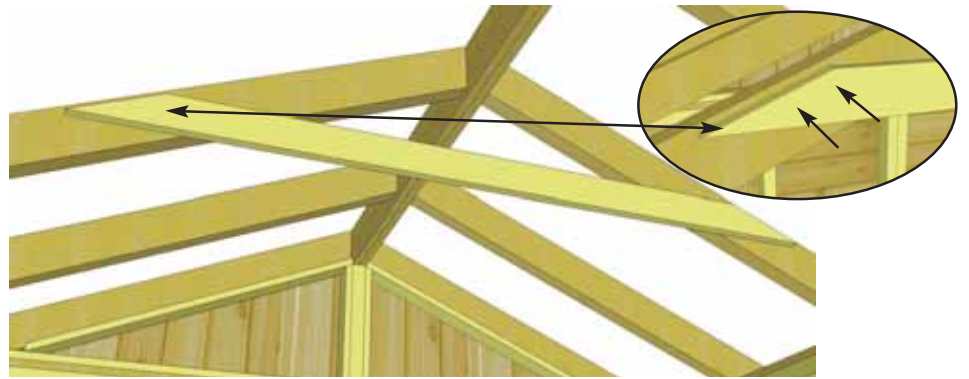
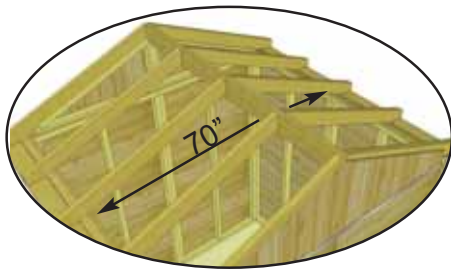

42. The **Roof Gusset 1- 3/4" x 3 1/2" x 48"** (**Part 3D**) is positioned on center rafter. Use level to square gusset and attach to rafter with **4 - 1 1/4" screws (Part C)**. **Pilot hole Gusset to prevent splitting.** If we required, have a helper(s) push at the front and at the rear near the top of the walls from the outside of shed until inside to inside measurement between the top plates is **70"** before attaching.

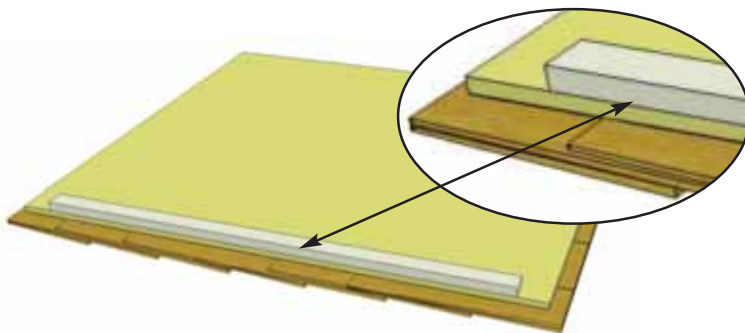

43. Carefully flip **Roof Panels (Parts 3E & 3F)** over so plywood sheathing is facing up. Attach one **Roof/Facia Cleat - 3/4" x 1 1/2" x 42"** (**Part 3G**) onto outside of each outside panel flush with plywood. Attach with **4 - 1 1/4" Screws (Part C)** evenly spaced. Attach remaining cleats to panels. The cleat provides for a greater nailing surface later when you attach side facia.



44. Carefully pickup and position outside panel on rafters. Place panel so it sits flush on 3rd rafter from the outside (doubled up rafter). Plywood on roof should be flush with end of rafter at bottom, and with seam of doubled up rafters.

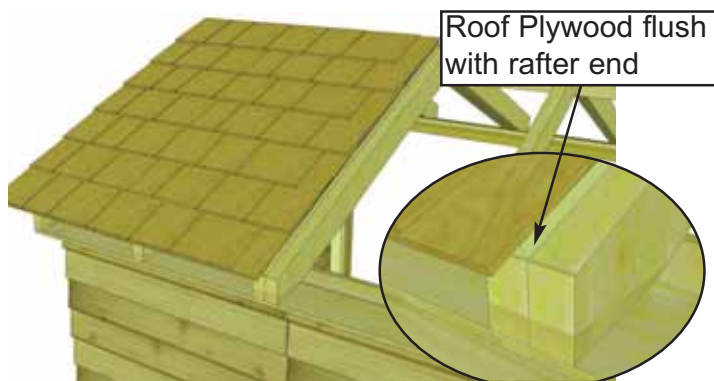

45. Screw panel down with **1 - 2 1/2" screws (Part B)**. Bottom and top row of shingles only.

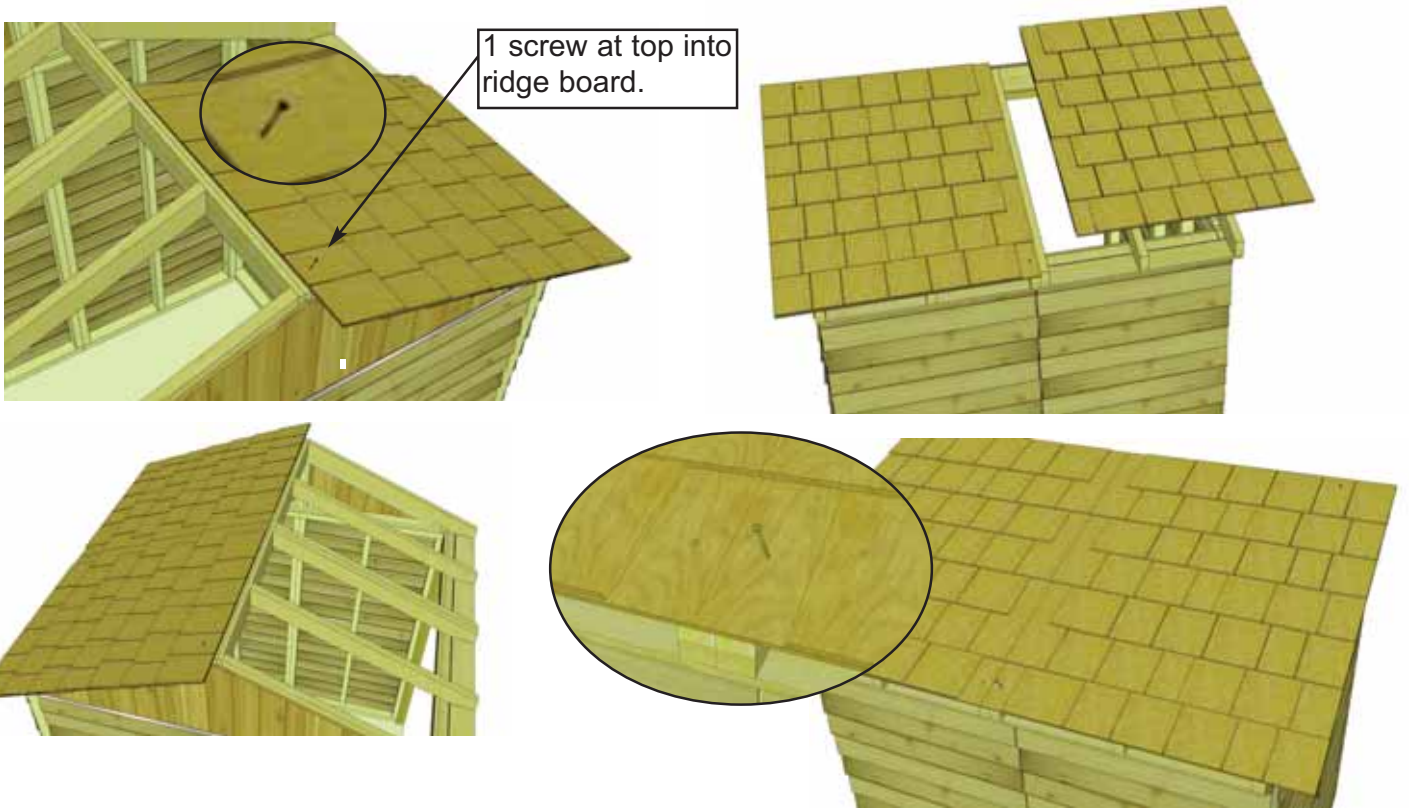

46. Screw panel down at top only with **1 - 2 1/2" screws (Part B)**. Place second roof panel on rafters. Align and attach. Roof will be completely secured in later Steps. Do not attach further until **Step 48**.

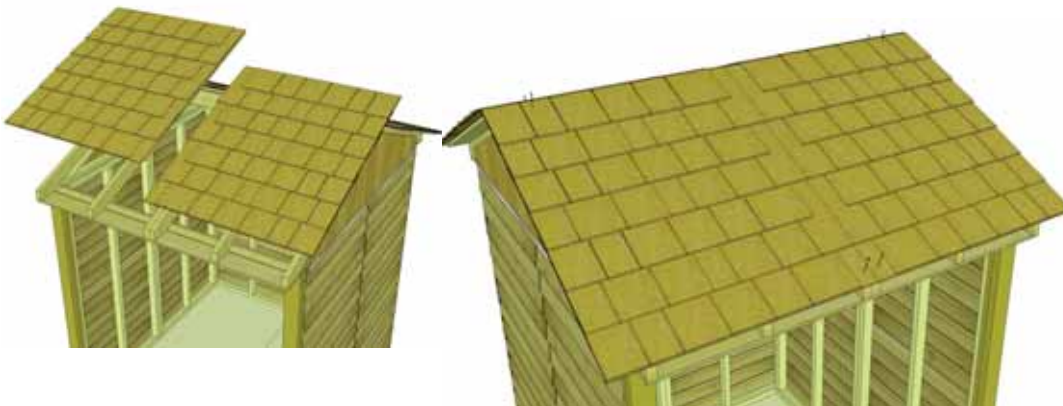

47. Position and attach front side roof panels as per **Steps 44-46**.

If Roof Panels do not align, check square of shed at top wall and adjust to square if necessary.

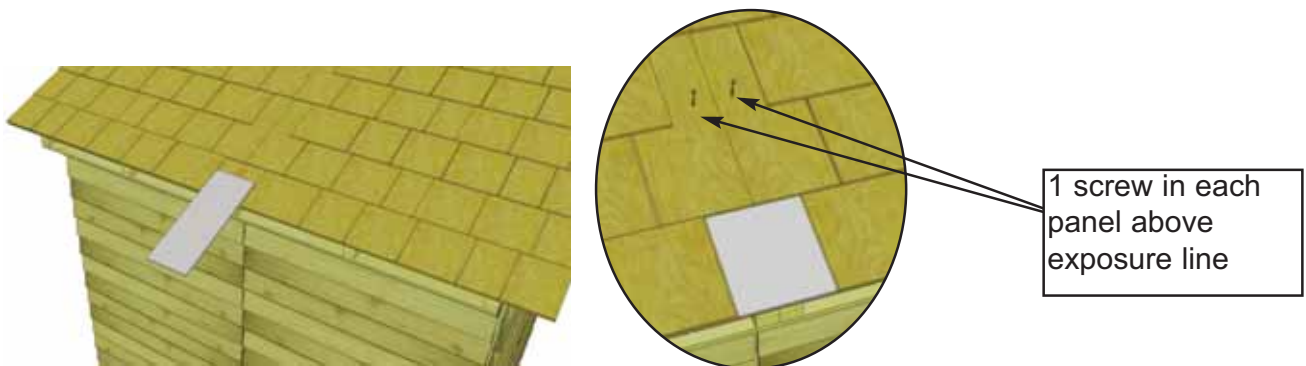

48. Slide in **Long Filler Shingle (Part 3F)**. Attach filler and roof above exposure line with **1 - 2 1/2" Screw (Part B)** in each panel. **Only attach first long filler shingle at this point.**

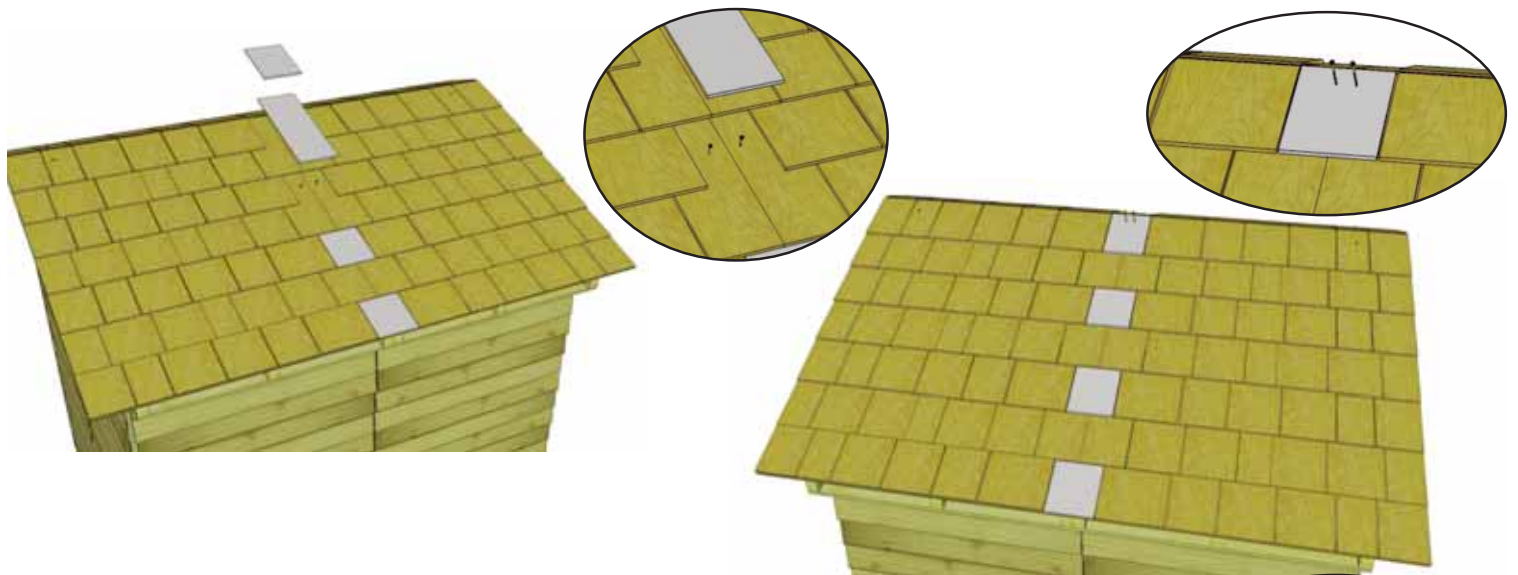

49. Slide in next long filler shingle and attach with **2 - 2 1/2" screws (Part B)** as per **Step 48**. Slide in remaining **Filler Shingles (Part 3H & 3I)** and attach in order. The top **Filler Shingle (Part 3I)** is shorter.

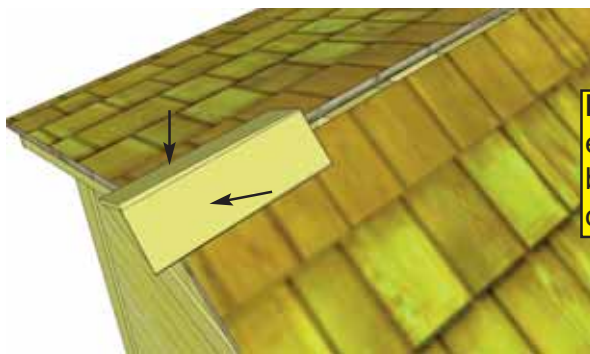
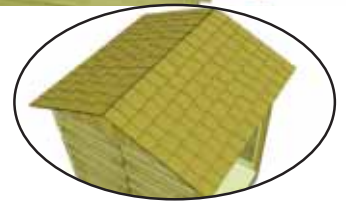

Important: Butt (thick) end of Ridge Cap will be facing towards the outside of shed.

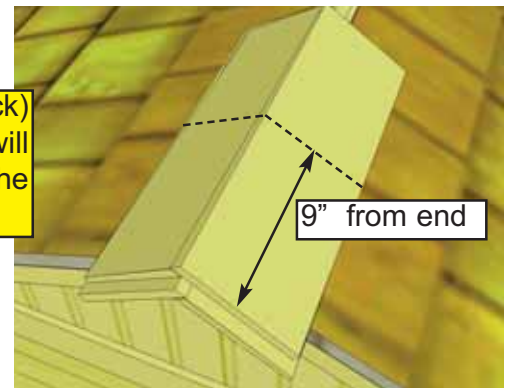

50. Place first **Roof Ridge Cap (Part 3J)** on roof peak overhanging shingles by approximately 2". Attach with **2 - 7/8" Shingle Nails (Part N)** 9" from end. Place 2nd **Ridge Cap** 1" back from 1st cap. Attach with **2 - 7/8" Shingle Nails (Part N)** 9" from end.

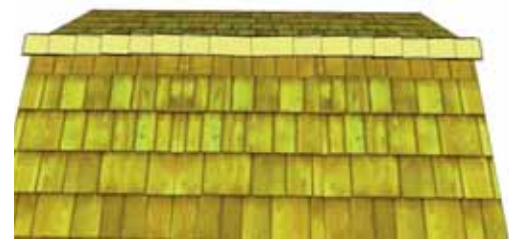
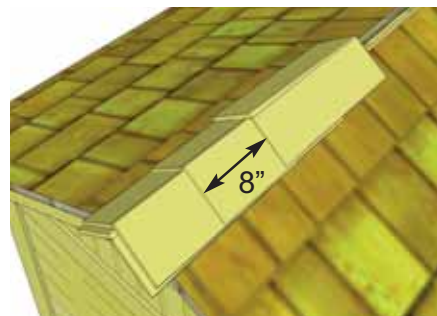
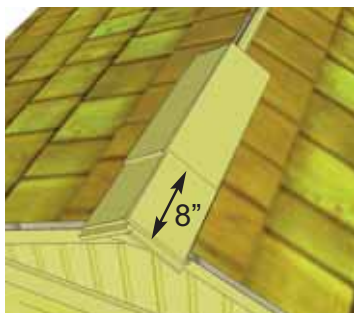

51. Place 3rd **Ridge Cap** 8" back from 2nd (enough to cover shingle nails). Attach 3rd ridge cap down as per **Step 50**. Continue to position and attach ridge caps until half roof is complete. From opposite side, position and attach ridge caps as described above. Score/cut 1 ridge cap to 12" or to fit in the center of roof. Attach center cap with **4 - 7/8" Shingle Nails (Part N)**.

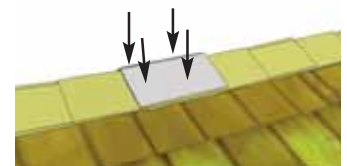

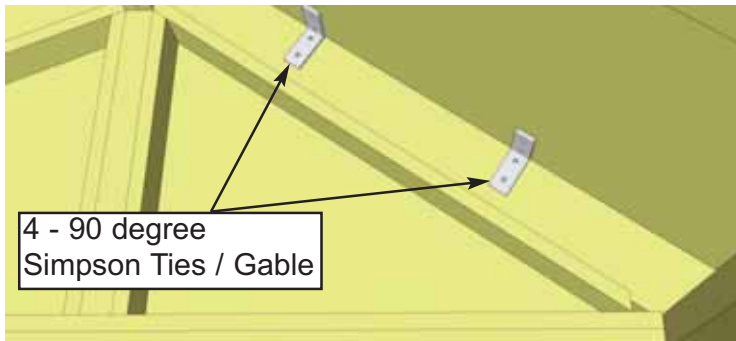

52. Attach 2 Simpson Strong Ties (Part G) per outside rafter with 4 - 1 1/4" screws (Part C). Total of 8 ties.

53. Further secure roof by attaching rafters to roof with 3 - 2 1/2" screws (Part B) per rafter.

3 - 2 1/2" angle screwed into each mid rafter. rill 1/8" pilot hole first

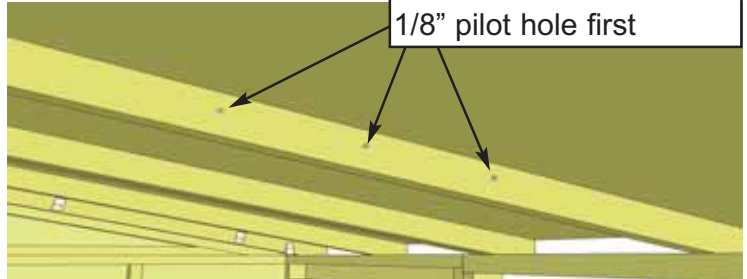
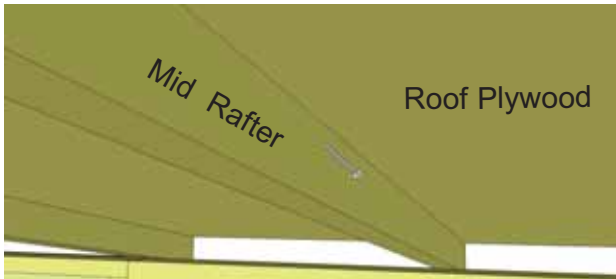

4. Miscellaneous Section

Exploded view of all parts necessary to complete the Miscellaneous Section. Identify all parts prior to starting.

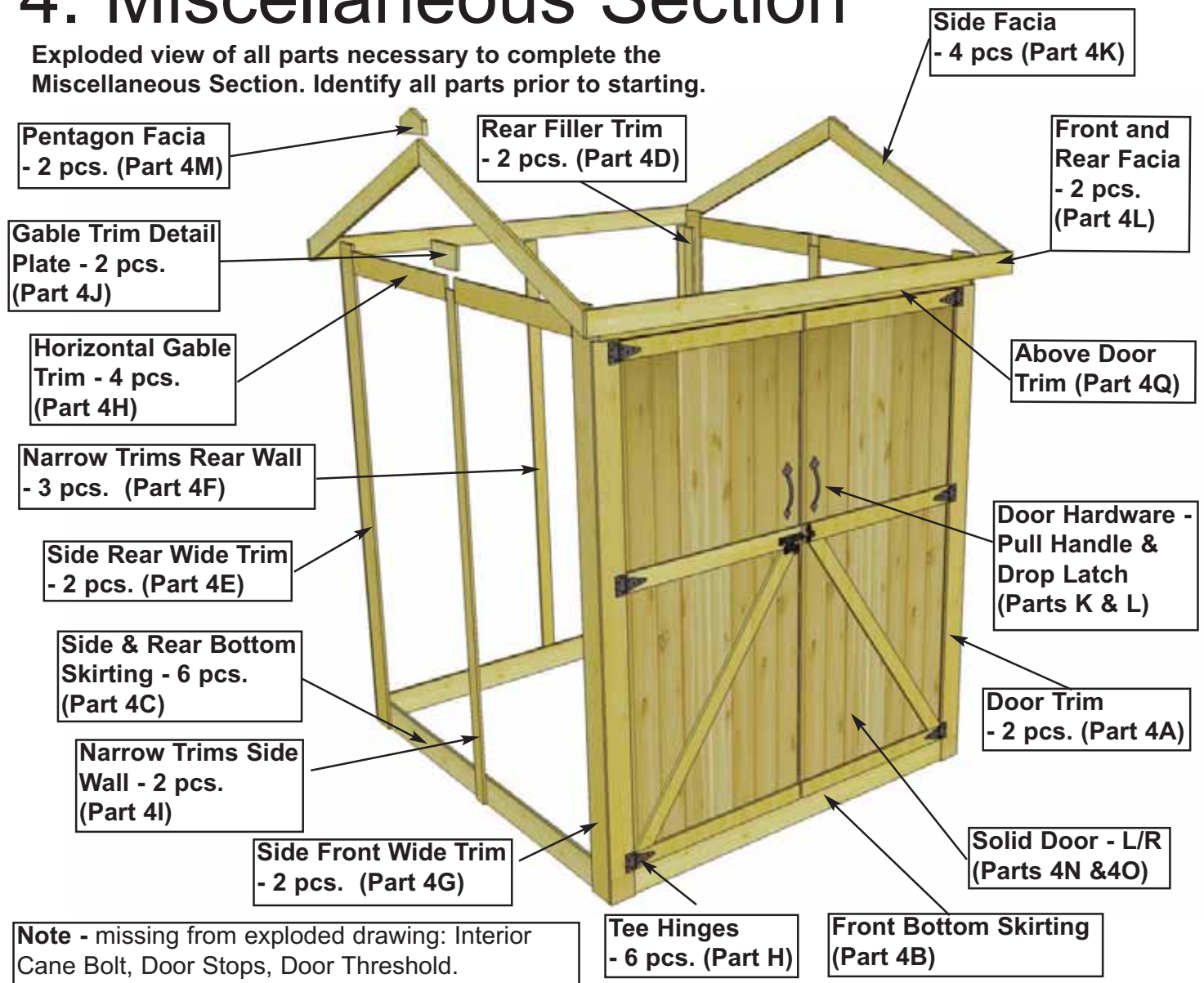

Note: All Trim, Facia and Bottom Skirting pieces will be positioned rough face out when installed.

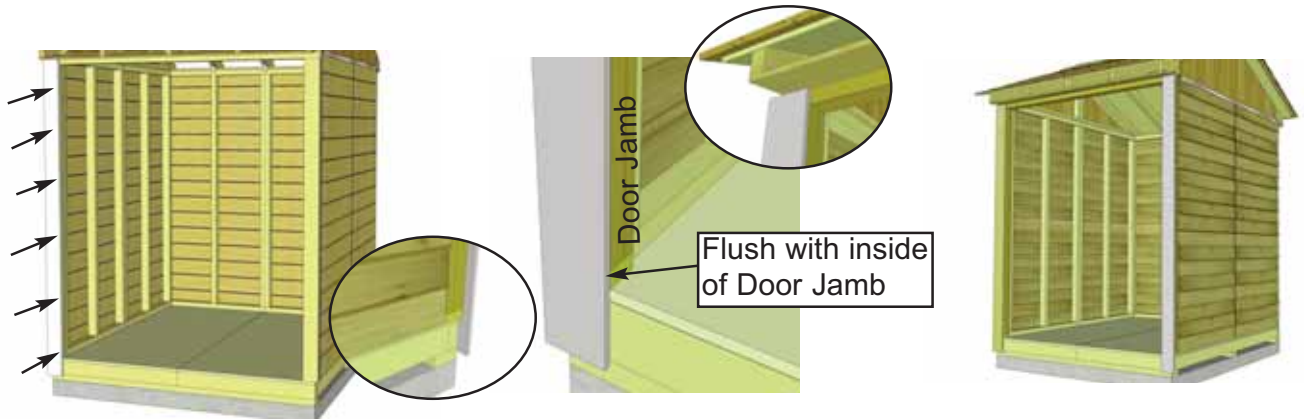

54. Locate both $3/4'' \times 4 \ 1/8'' \times 79''$ Door Trims (Part 4A). Position a Trim so it covers the Door Jamb and is flush with the inside of it. Secure with 8 - $1 \ 1/2''$ Finishing Nails (Part F) per piece.

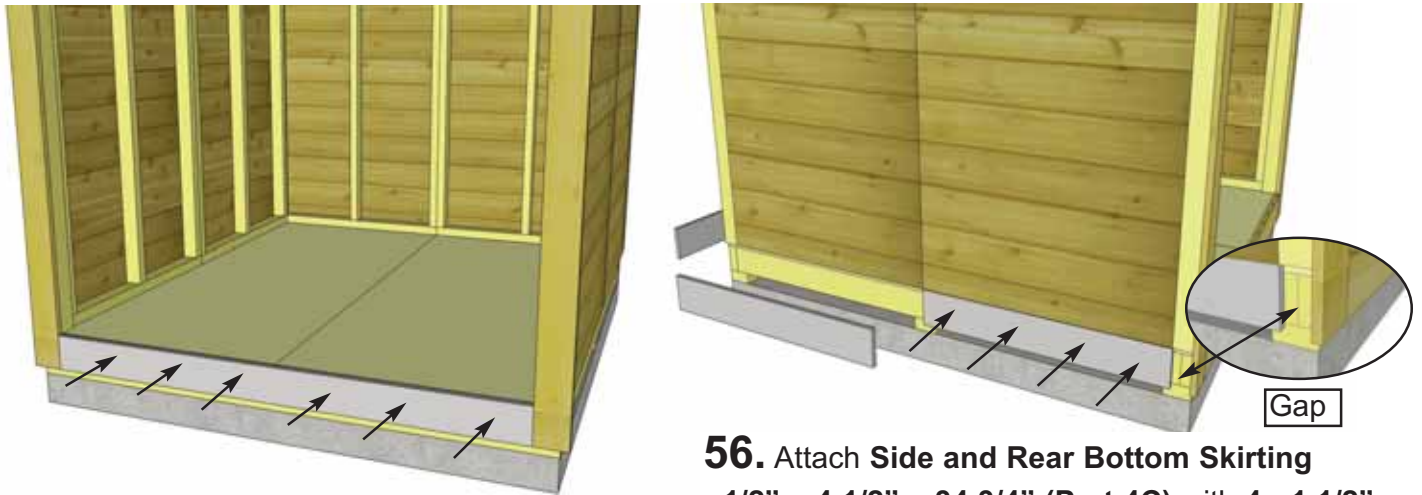

55. Attach Front Bottom Skirting - $3/4'' \times 4 \ 1/2'' \times 64''$ (Part 4B) between door trims with 6 - $1 \ 1/2''$ Finishing Nails (Part F).

56. Attach Side and Rear Bottom Skirting - $1/2'' \times 4 \ 1/2'' \times 34 \ 3/4''$ (Part 4C) with 4 - $1 \ 1/2''$ Finishing Nails (Part F) per piece.

57. Attach Rear Filler Trims - 4 pcs- $5/8'' \times 2 \ 1/2'' \times 75''$ - (Part 4D) with 6 - $1 \ 1/2''$ Finishing Nails (Part F). Strips are positioned flush with siding and bottom Skirting.

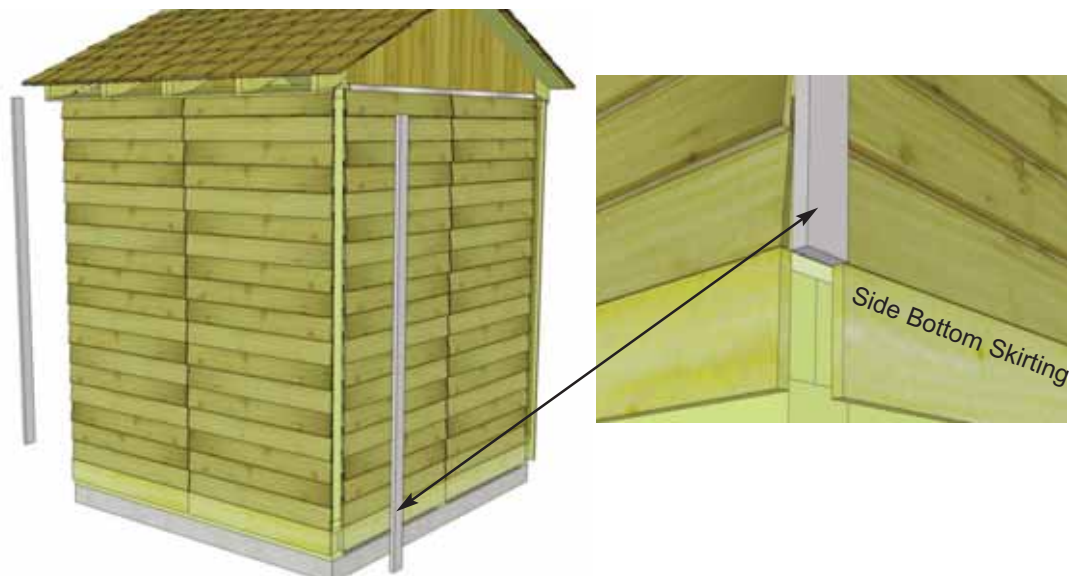

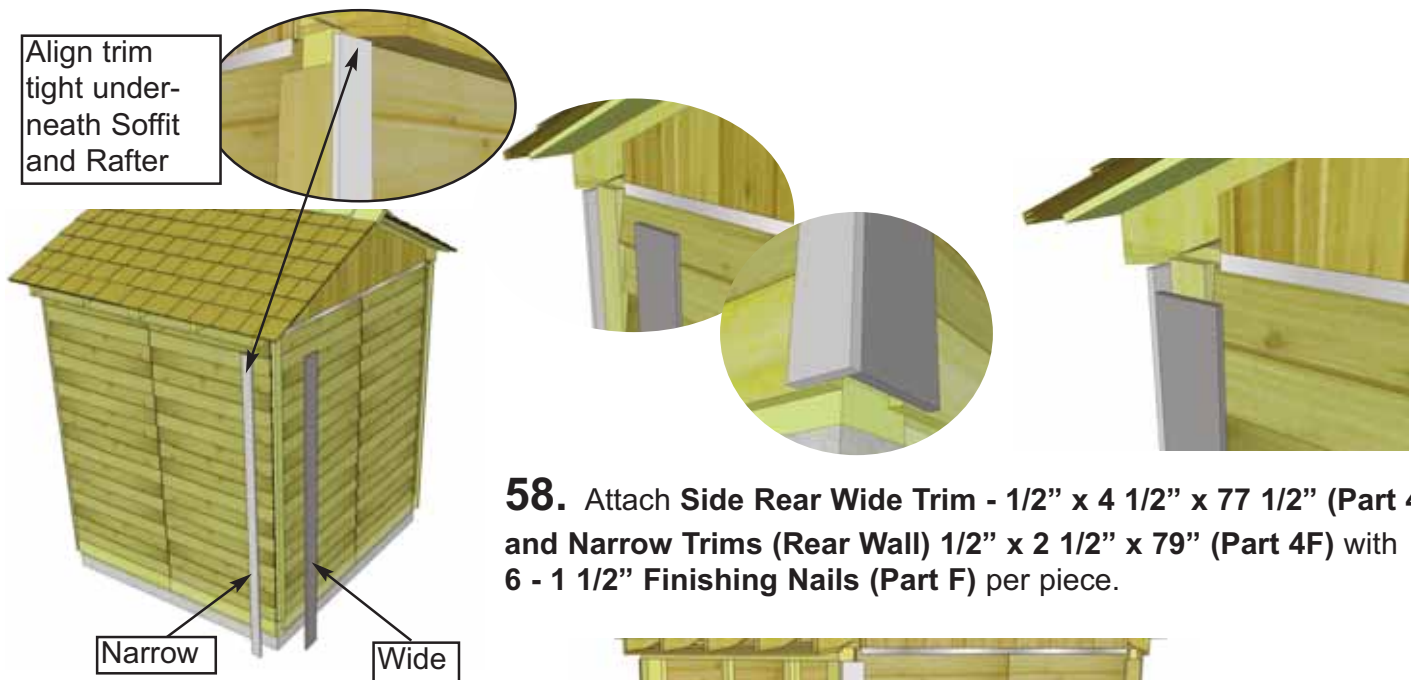

58. Attach **Side Rear Wide Trim - 1/2" x 4 1/2" x 77 1/2"** (Part 4E) and **Narrow Trims (Rear Wall) 1/2" x 2 1/2" x 79"** (Part 4F) with **6 - 1 1/2" Finishing Nails (Part F)** per piece.

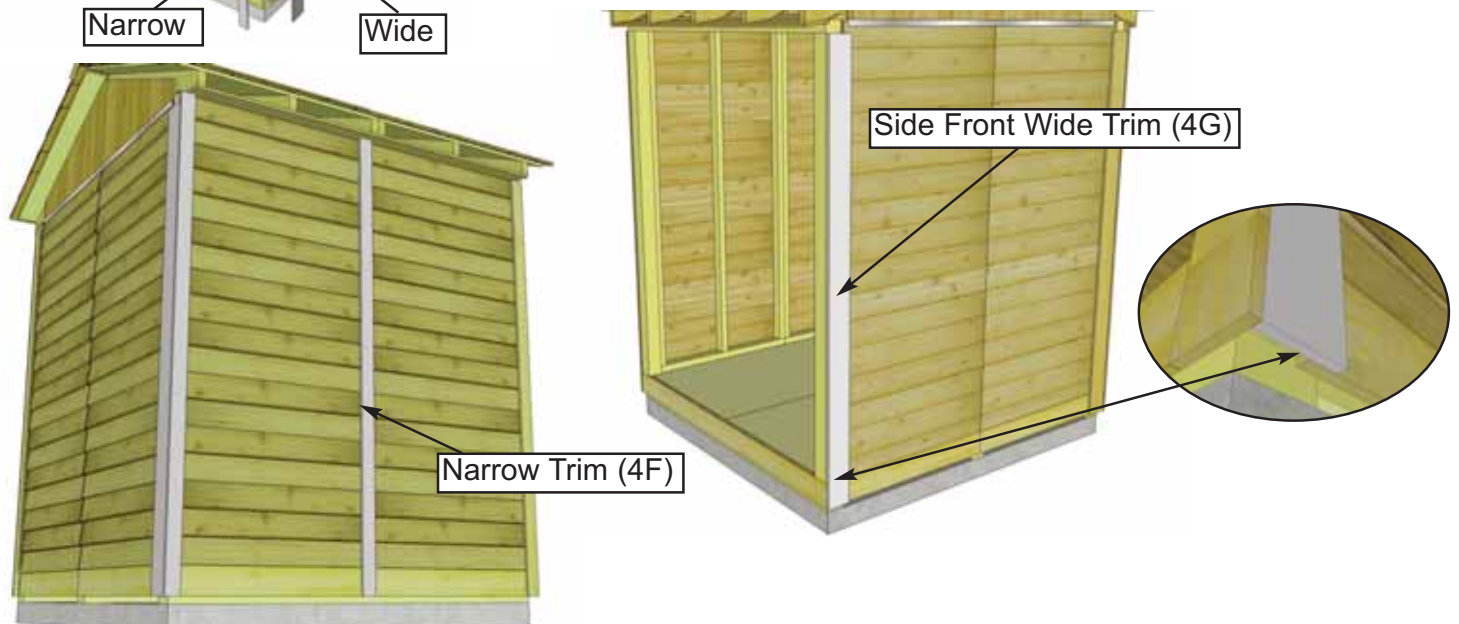

59. Attach **Narrow Trim (Rear Wall) 1/2" x 2 1/2" x 79"** (Part 4F) on wall seam. Use **6 - 1 1/2" Finishing Nails (Part F)** to secure. Attach **Side Front Wide Trims - 1/2" x 4 1/2" x 77 1/2"** (Part 4G) with **6 - 1 1/2" Finishing Nails (Part F)**. Door Trim (4A) will cap side trim as shown above.

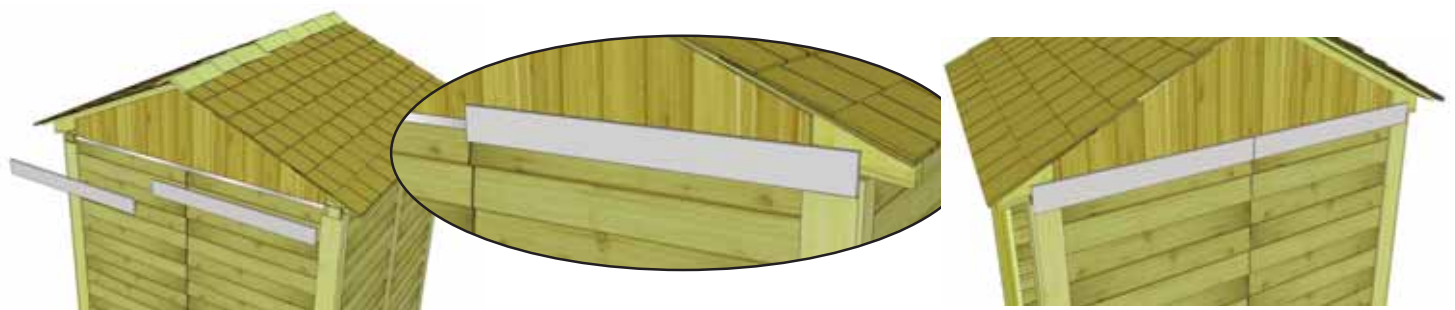

60. Attach **Horizontal Gable Trims - 4 pcs 1/2" x 4 1/2" x 37 3/4"** (Part 4H) with **4 - 1 1/2" Finishing Nails (Part F)** per piece. Position over gable and wall seam. Make sure gable trims covers flashing completely. Align even with outside of wide trim leaving a slight gap a center.



61. Attach **Narrow Trim (Side Wall)** - 1/2" x 2 1/2" x 77 1/2" (Part 4I) with 8 - 1 1/2" Finishing Nails (Part F).

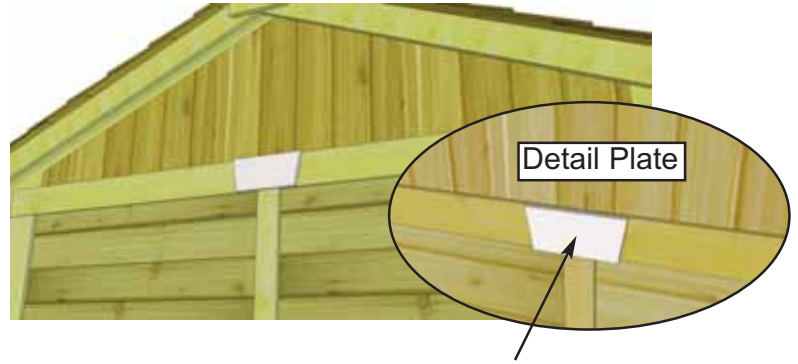

62. Attach **Horizontal Gable Detail Plate** (Part 4J) with 4 - 1 1/2" Finishing Nails (Part F).

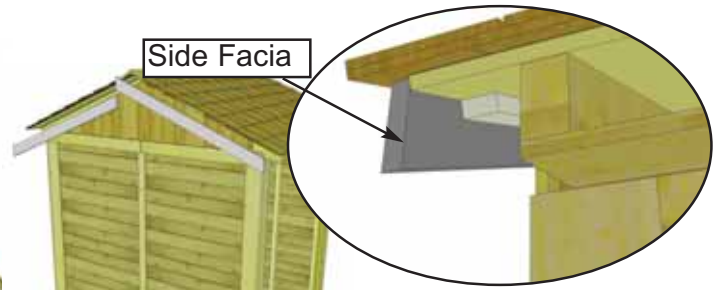

63. Attach **Side Facia** 3/4" x 3 1/2" x 46" (Part 4K) to edge of plywood roof sheathing and roof cleat with 6 - 1 1/2" Finishing Nails (Part F).

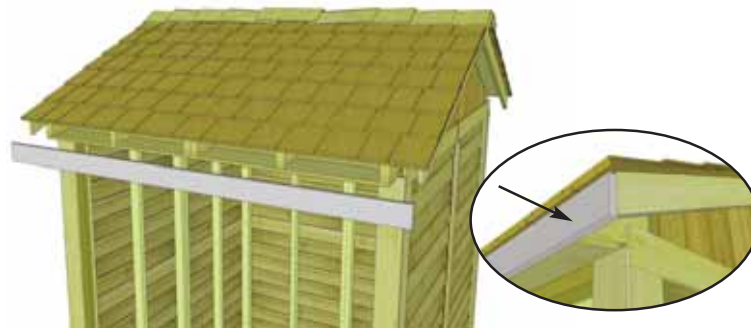

64. Attach **Front and Rear Facia** - 3/4" x 3 1/2" x 79 1/2" (Part 4L) to ends of rafters with 10 - 1 1/2" Finishing Nails (Part F). Front Facia will cap side facia in corners.



65. Attach **Pentagon Facia Plate** (Part 4M) where Side Facia meet at the peak with 4 - 1 1/2" Finishing Nails (Part F).

Note, illustration of Hinge may not be accurate. The # of screw holes in the hinge may vary from three to four depending on model.



Important-
Drill Pilot Holes
to prevent
splitting.

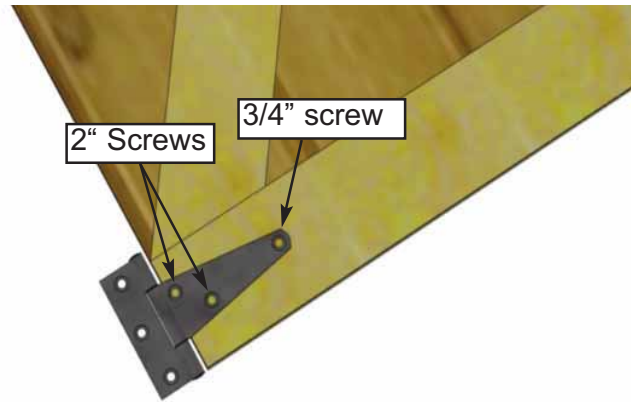

66. Locate **Left and Right Doors (Parts 4N & 4O)**. Lay with framing down. Attach **3 Door Tee Hinges (Part H)** using **Black Headed 3/4" and 2" screws (Parts I & J)** as shown above. Position hinges equally on door trim with barrel of hinge tight to edge of door. Complete both doors.



67. Starting with the **Left Door (Part 4N)**, position in opening with a **1/2" gap** on bottom and approximately **3/8" on the side**. Use **Shim Shingle (Part 4P)** to shim door in place at the bottom.

Important-
Drill Pilot Holes
to prevent
splitting.

3/8" on
side.
1/2" gap
at bottom

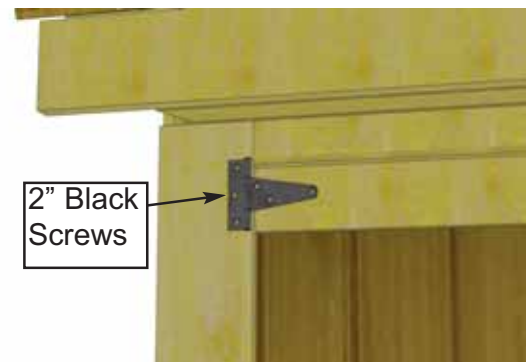
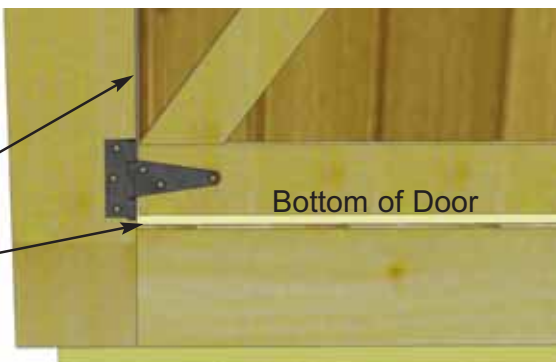

68. With door aligned, attach door hinge to door trim with **3 - 2" Black Headed Screws (Part I)**.
Hint: Do not attach all the 2" screws in each hinge until both doors are positioned correctly into place. Drill pilot holes in door trim prevent wood from splitting. When satisfied with door positioning, complete all 2" screws then.



69. Position and attach **Right Door (40)** as per **Steps 67-68**. Door position may need slight adjusting to open and close correctly. When satisfied, complete all **2" Black Headed Screws (Part I)**
Note, Do not over tighten hinge screws when using screw gun.

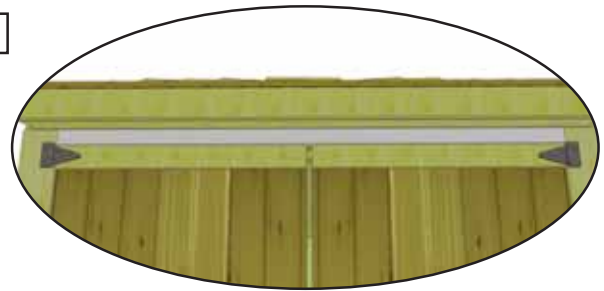

70. Attach **Above Door Trim - 1/2" x 1 1/4" x 64"** (**Part 4Q**) with **6 - 1 1/2" Finishing Nails (Part F)**.
 Leave small gap to allow for proper door opening and closing.

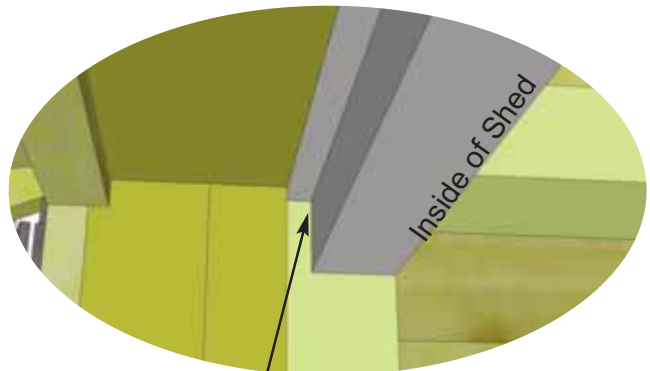
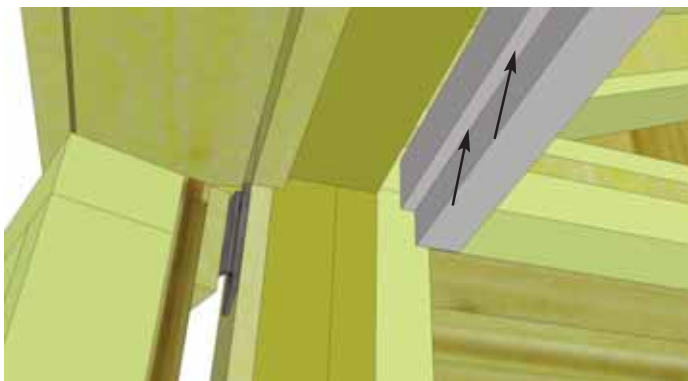

71. Attach **Horizontal Door Stop - 1 1/2" x 2 1/2" x 64"** (**Part 4R**) with dado facing out, tight against door header. Align so Dado cut is flush with Header leaving approximately a 1" overhang in the doorway. Attach with **6 - 2" screws (Part E)**.

Hor. Door Stop with Dado cut

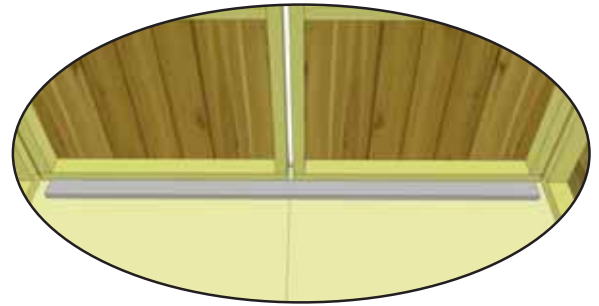
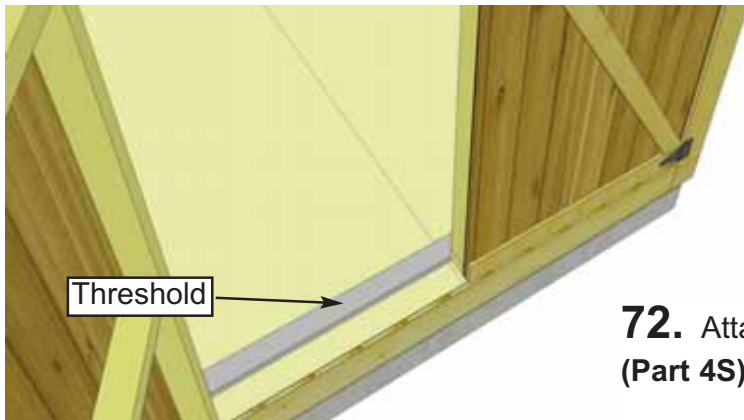

72. Attach **Door Threshold - 3/4" x 2 1/2" x 62 1/2"** (Part 4S) with **4 - 2" screws (Part E)**.



73. Attach **Interior Door Flange - 1/2" x 2 1/2" x 71"** (Part 4T).

Position on inside door frame (**left door from outside**) using **6 - 2" screws (Part E)**.

Position on inside edge of door frame so flange overlaps door frame by **1"**.

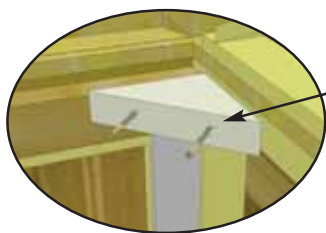

74. Attach front **Front Triangular Corner Brackets - 1 1/2" x 5 1/2" x 5 1/2"** (Part 2G) to header and wall frame with **2 - 2 1/2" screws (Part B)** per piece.



75. Attach **Interior Cane Bolt (Part M)** to vertical door flange with **3/4" Black Headed Screws (Part J)**.

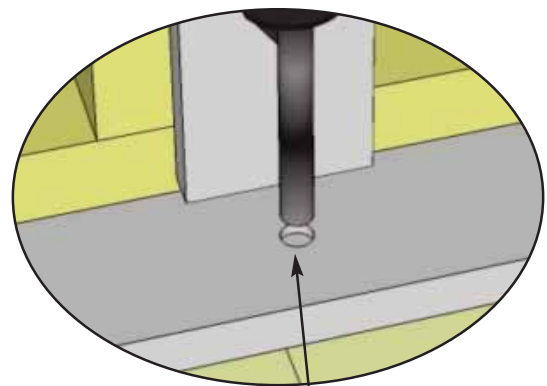

Drill **1/2" Diameter Hole** to accommodate rod of Cane Bolt

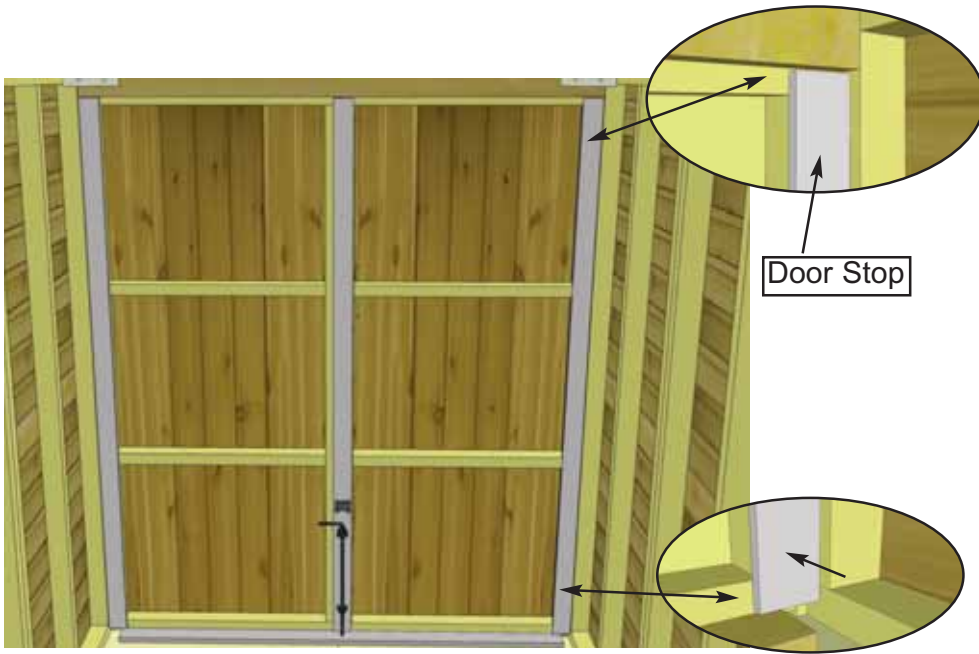

76. Position **Door Stops** **1/2" x 2 1/2" x 71" (Part 4U)** in each corner screwing into door framing using **6 - 2" screws (Part E)**. Before attaching stop to door, check positioning to confirm Door Stop does not bind and adjust accordingly.

Important - Drill pilot holes with 1/8" drill bit prior to securing with screws to prevent wood splitting. On 3/4" screw, drill shallow pilot hole only.

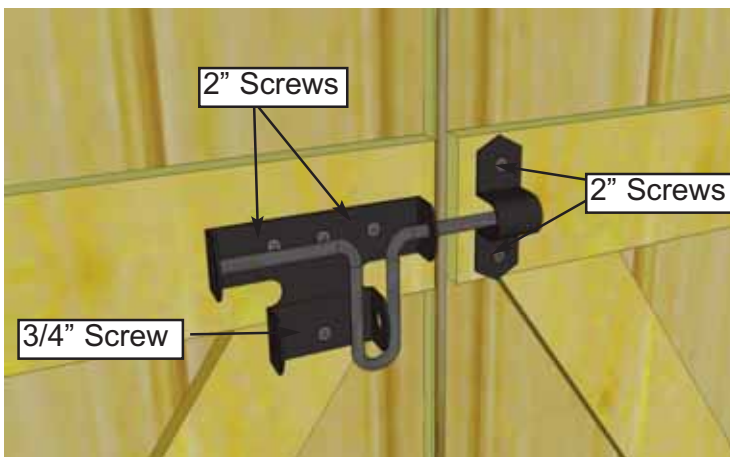

77. Attach **Black Drop Latch (Part L)** as illustrated above with **2" & 3/4" Black Screws (Parts I & J)**. Note how female part of Drop Latch is positioned higher than male. Do a dry run first to position Drop Latch correctly. **Important** - Drill a shallow pilot hole with 1/8" drill bit prior to securing with screws to prevent wood splitting.



78. Attach **Door Handles (Part K)** with **3/4" Black Screws (Part J)**.



Congratulations on assembling your 6x6 Maximizer Storage Shed!

Note; Our Sheds are shipped as an unfinished product. If exposed to the elements, the western red cedar lumber will weather to a silvery-gray color. If you prefer to keep the cedar lumber looking closer to the original color, we suggest that you treat the wood with a good oil base wood stain. You may also wish to paint your new shed rather than stain it. In both cases we recommend that you consult with a paint and stain dealer in your area for their recommendations.



We hope your experience assembling your 6x6 Maximizer Storage Shed has been both positive and rewarding.

We value your feedback and would like to hear back from you on how well we are doing in the following areas:

- 1. Customer Service**
- 2. On Time Shipping**
- 3. Motor Freight Delivery**
- 4. Quality of Materials**
- 5. Assembly Manual**
- 6. Overall Satisfaction.**

Please call, write or email us at:

Outdoor Living Today

Canadian Address
9393 287th Street
Maple Ridge, British Columbia
Canada V2W 1L1

United States Address
P.O. Box 96
Sumas, Washington
USA 98295

The materials contained in this Assembly Manual may be downloaded or copied provided that ALL copies retain the copyright and any other proprietary notices contained on the materials. No material may be modified, edited or taken out of context such that its use creates a false or misleading statement or impression as to the positions, statements or actions.