

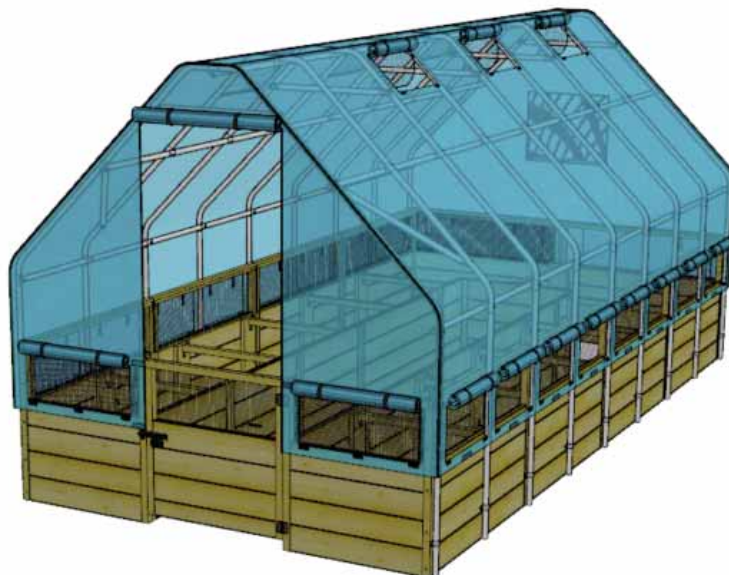

8x16 Garden in a Box with Greenhouse Cover Assembly Manual

Thank you for purchasing a
8x16 Garden in a Box with Greenhouse
Cover. Please take the time to identify
all the parts prior to assembly.

Version #1.2
Jan 27, 2022



In colder climates, please remove your Garden in a Box
Plastic Cover during the winter months and store in
included bag in a dry warm location.

Do not leave cover on during any large snow storms or
extreme weather phenomenon such as hurricanes,
tornadoes or heavy wind storms.

Cover can easily be taken off in minutes if such weather
patterns are forecast in your area.

We recommend once a year in the early spring to check
that all fasteners are snug and to tighten if loose.

Plastic cover can be cleaned with a mild soap and a cloth.











**Customer agrees to hold Outdoor Living Today
and any Authorized Dealers free of any liability
for improper installation, maintenance and
repair.**

In the event of a missing or broken piece, call the Outdoor Living Today Customer Support Line @ 1-888-658-1658 within 30 days of the delivery of your purchase. It is our commitment to you to courier replacement parts, free of charge, within 10 business days of this notification. Replacement parts will not be provided free of charge after the 30 day grace period.

All structures purchased from Outdoor Living Today are covered for a period of one year for defects in manufacturing and workmanship. Costs incurred for customer installations are not included.

Failure to use supplied parts included in this kit could result in poor product performance and may void your warranty. Please contact Outdoor Living Today's Customer Toll Free Line if you plan to deviate from our written instructions.

Thank you for purchasing our 8x16 Garden in a Box with Greenhouse Cover. Please take the time to identify all the parts prior to assembly.

| | | |
|----------------|--|-------------|
| Part 1 |  | x 18 |
| Part 2 |  | x 5 |
| Part 3 |  | x 30 |
| Part 4 |  | x 5 |
| Part 5 |  | x 7 |
| Part 6 |  | x 16 |
| Part 7 |  | x 2 |
| Part 8 |  | x 4 |
| Part 9 |  | x 5 |
| Part 10 |  | x 4 |
| Part 11 |  | x 5 |

Hardware

& Miscellaneous

72 x S2 - 1 1/4" Screws



2 x M6x60



43 x M6x55



12 x M6x35



1 x BR1 - Square Drive Bit



2 x Protective Stripping Rolls (50ft each)



20 x Washers

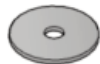

20 x 1 1/4" Pan Head Screws



20 x Clips

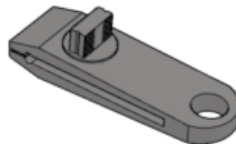

Greenhouse Cover

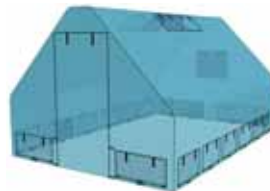

36 x Pipe Clamps



Storage Bag



Tools Required

(Not Provided)



Screw Gun/Drill



Pliers



Phillips Screwdriver

Exploded View

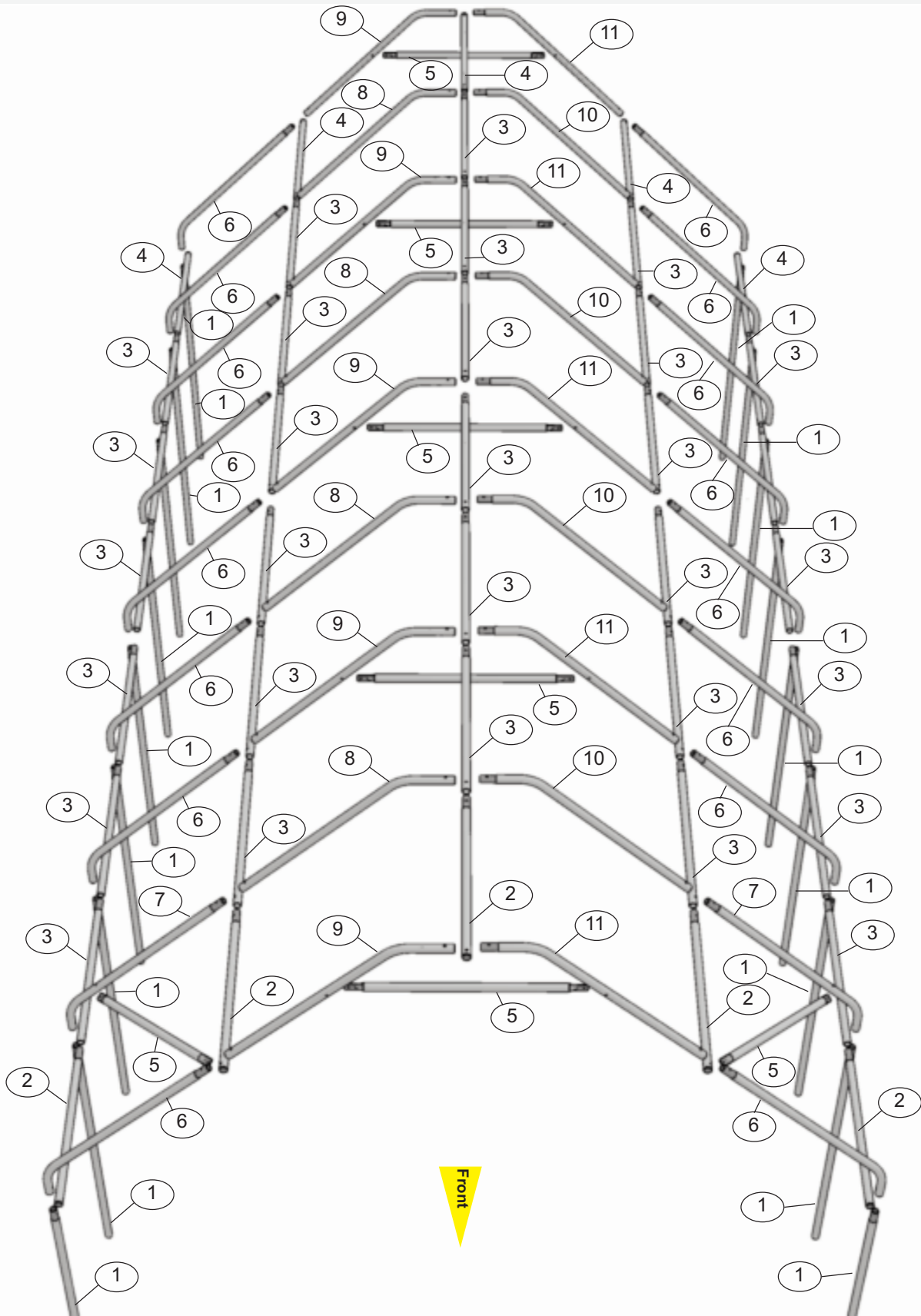

| Step | Parts & Hardware | |
|------------|------------------|------------|
| | 1 | 1 x Part 4 |
| 1 x Part 9 | | 1 x M6x55 |
| | | |

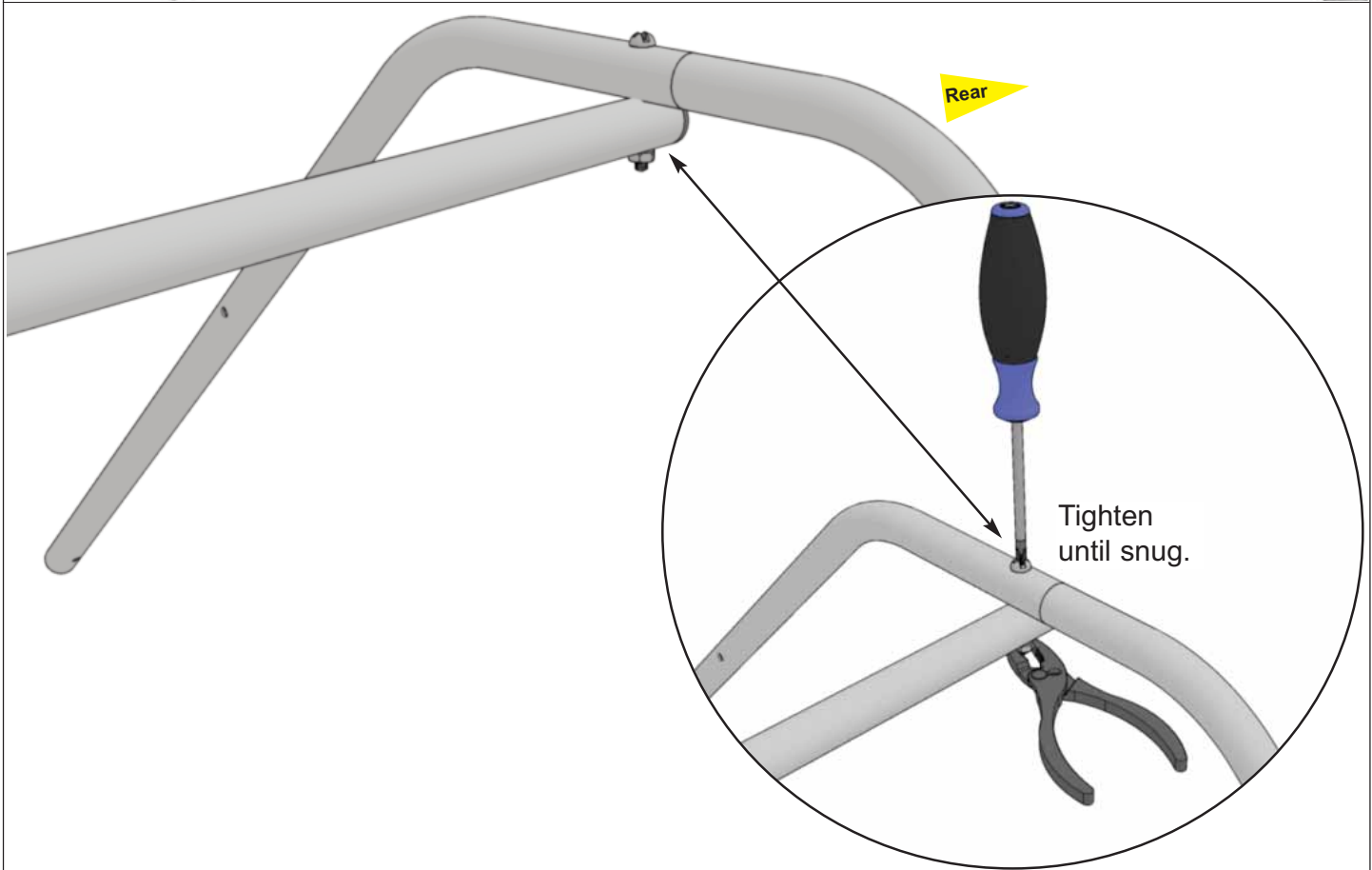
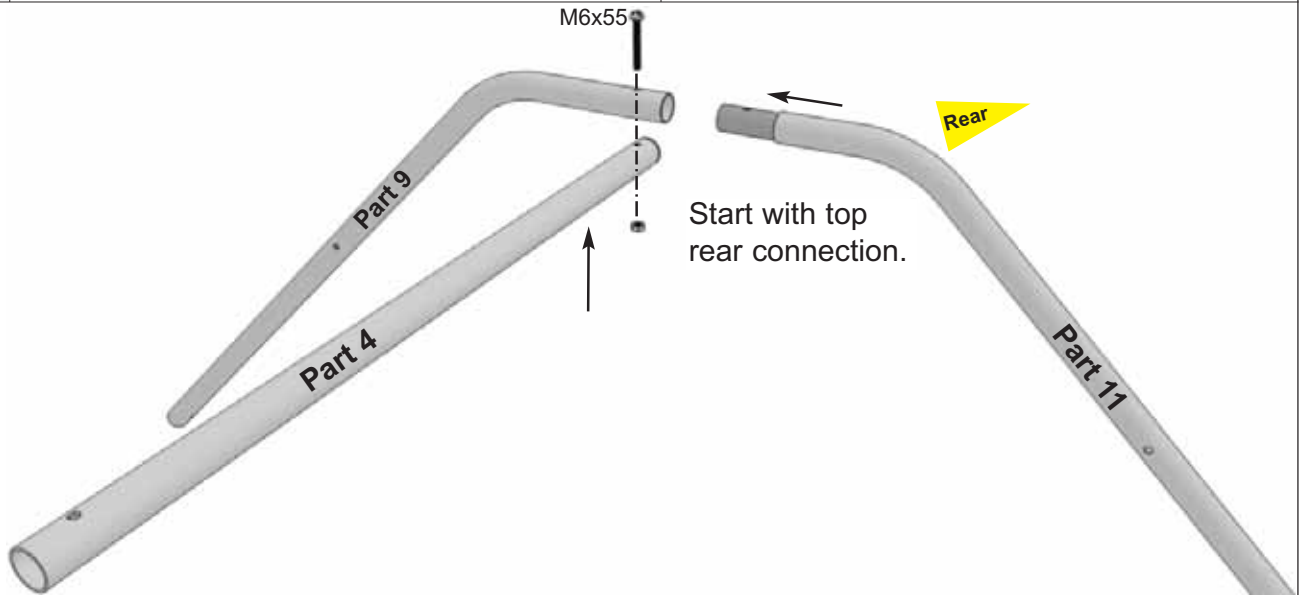

Step

2

Parts & Hardware

1 x Part 5



2 x M6x35

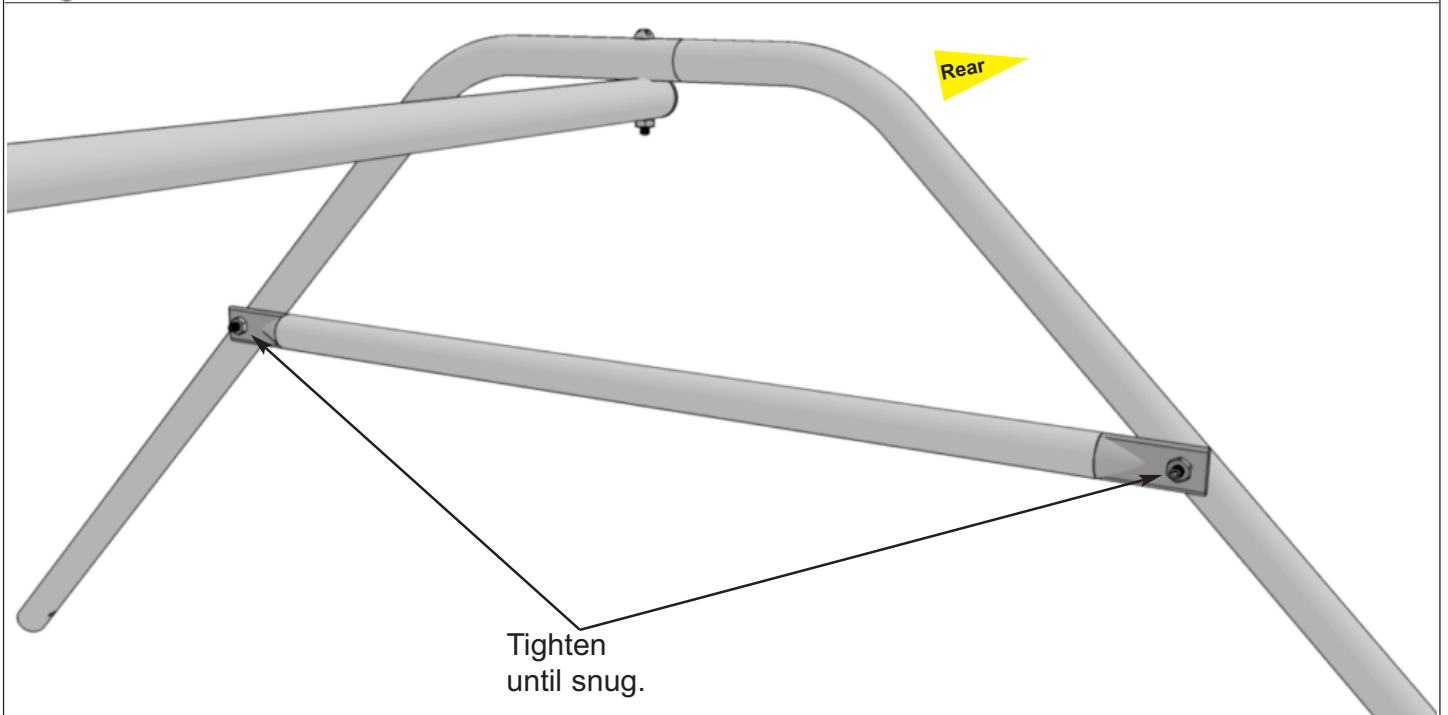
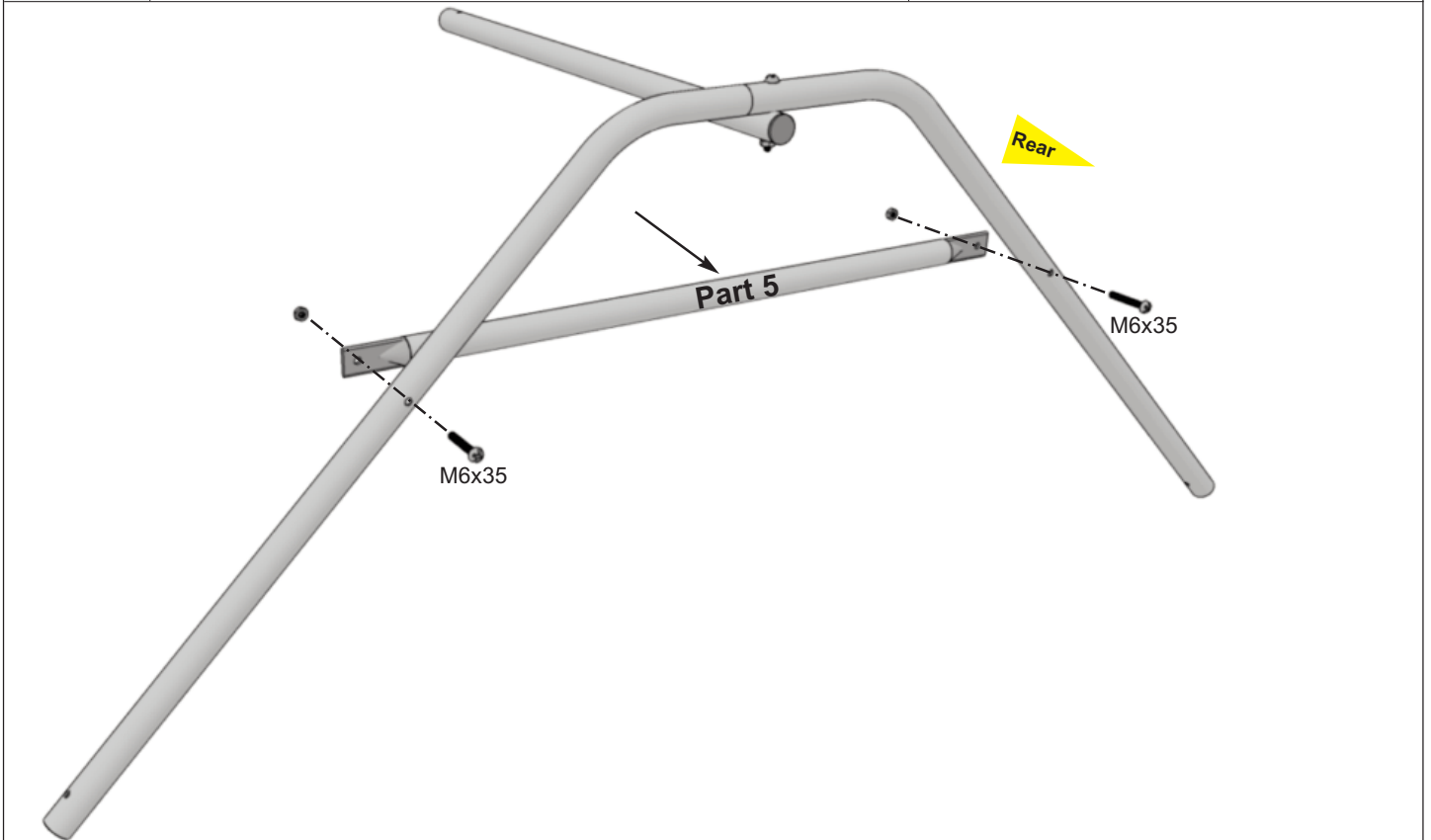

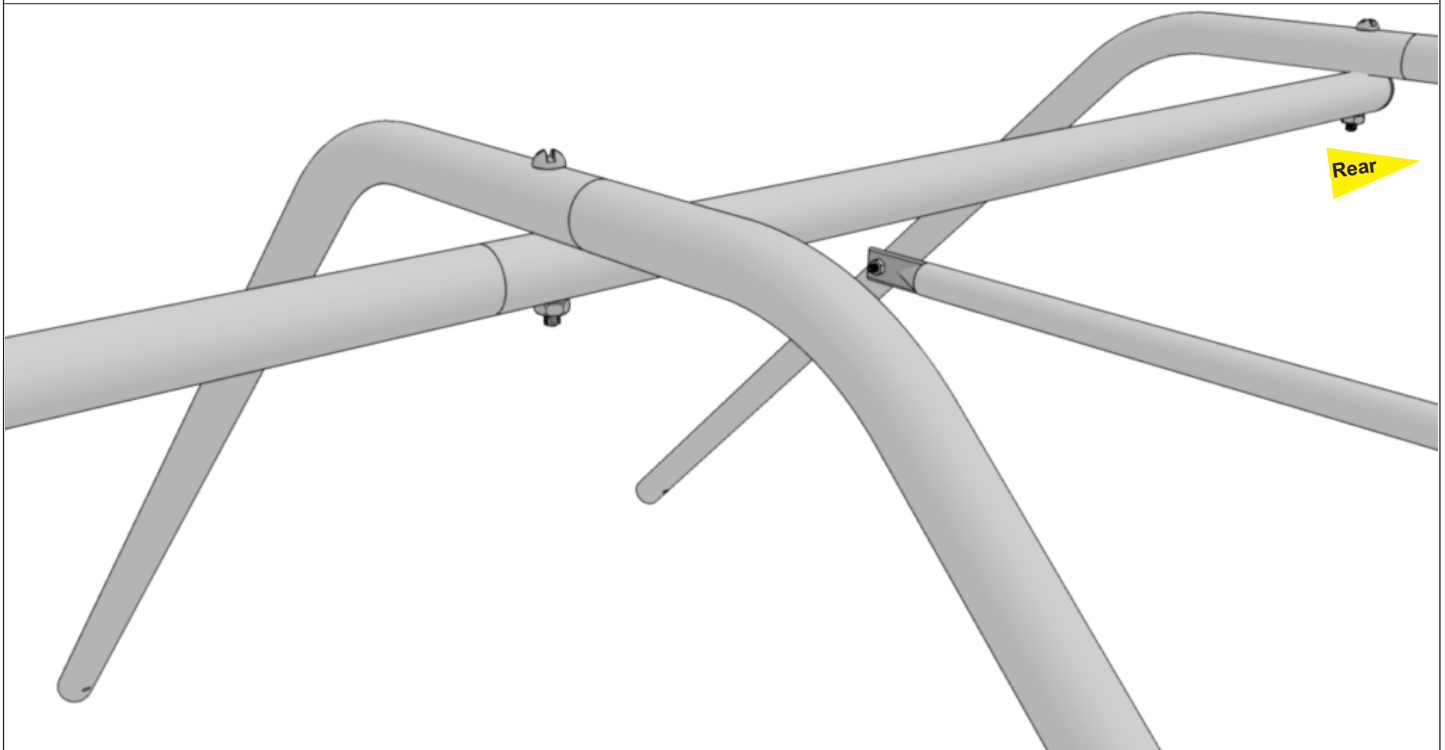
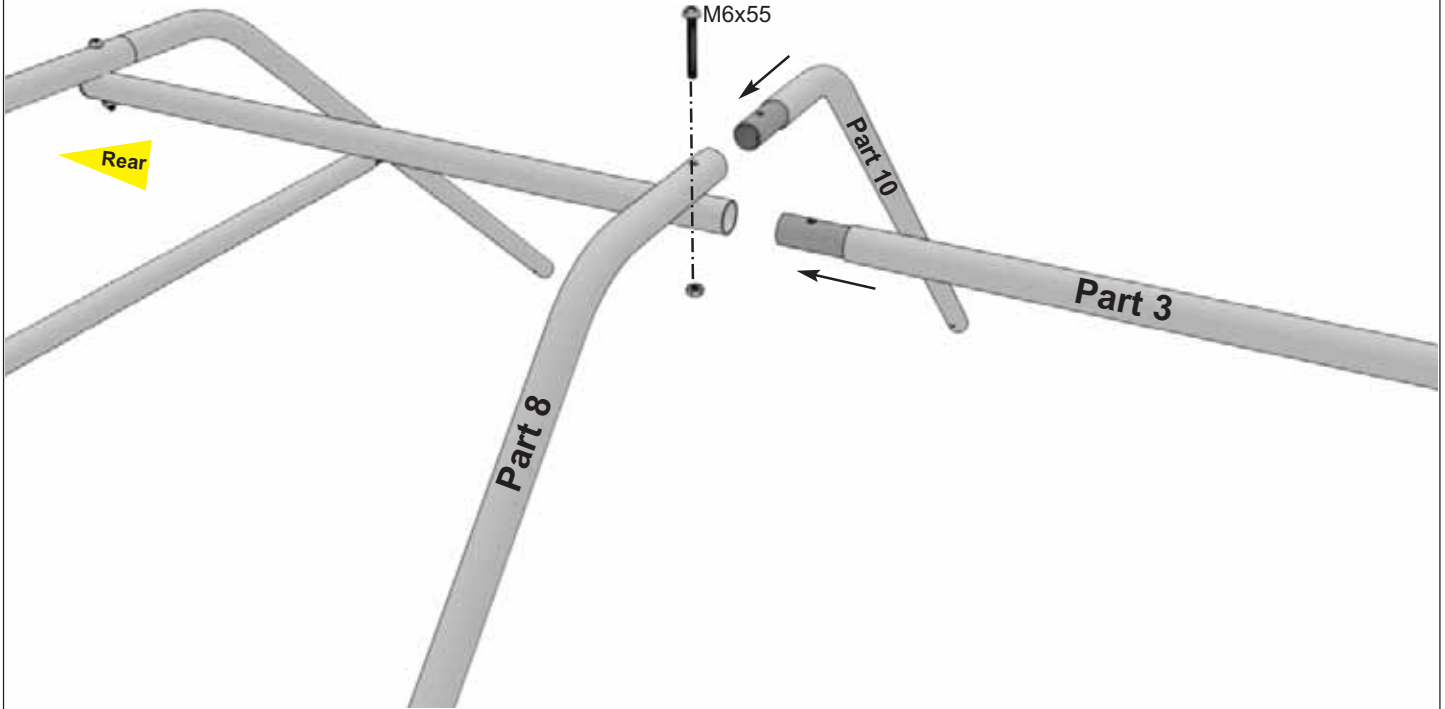

| Step 3 | Parts & Hardware | |
|------------------|------------------|-------------|
| | 1 x Part 3 | 1 x Part 10 |
| | 1 x Part 8 | 1 x M6x55 |

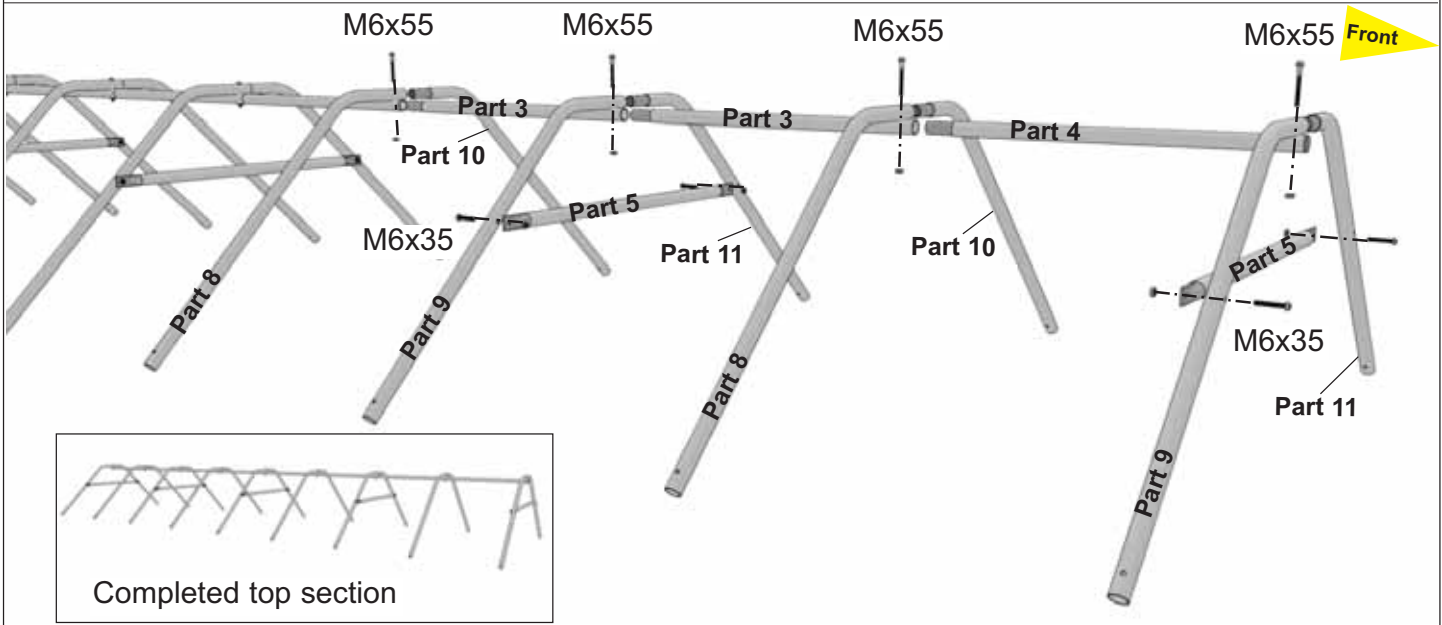
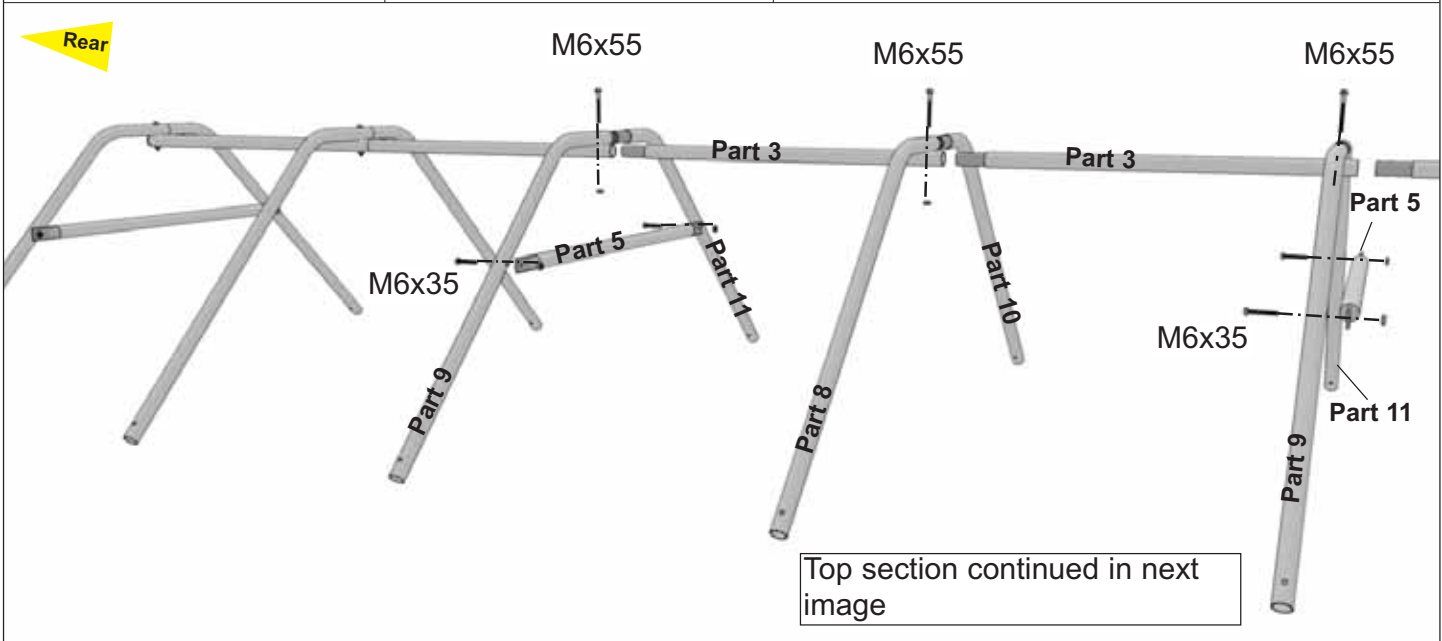

| Step 4 | Parts & Hardware | |
|------------------|------------------|-------------|
| | 3 x Part 8 | 3 x Part 10 |
| 1 x Part 4 | 3 x Part 3 | |
| 4 x Part 9 | 4 x Part 11 | |
| 8 x M6x35 | 7 x M6x55 | 4 x Part 5 |



| Step | Parts & Hardware | | |
|---|------------------|--|---|
| | 5 | 1 x Part 7 | 8 x Part 6 |
| 1 x Part 4 | | 6 x Part 3 | |
| 1 x Part 2 | | 1 x Part 5 | |
| 1 x M6x35 | | 8 x M6x55 | 1 x M6x60 |
|  | |  |  |

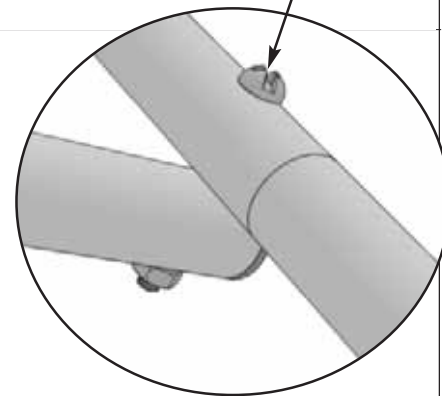
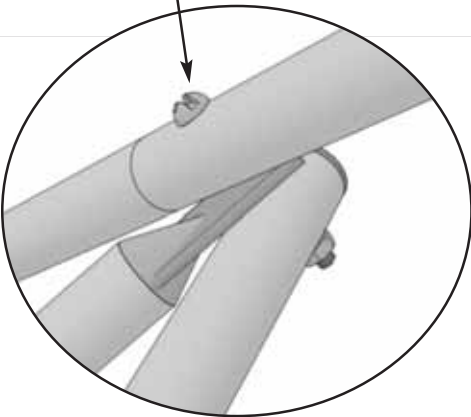
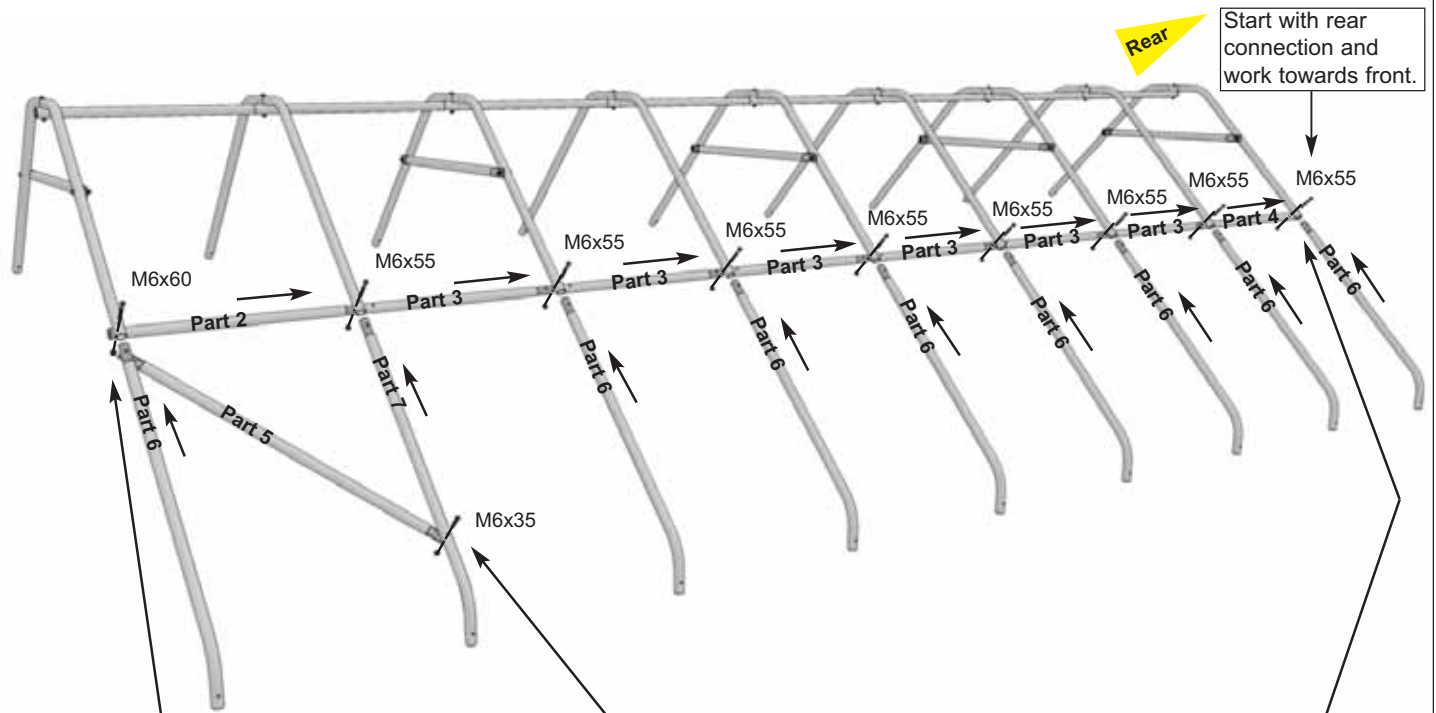

| Step 6 | Parts & Hardware | |
|------------------|------------------|------------|
| | 1 x Part 7 | 8 x Part 6 |
| 1 x Part 4 | 6 x Part 3 | |
| 1 x Part 2 | 1 x Part 5 | |
| 1 x M6x35 | 8 x M6x55 | 1 x M6x60 |

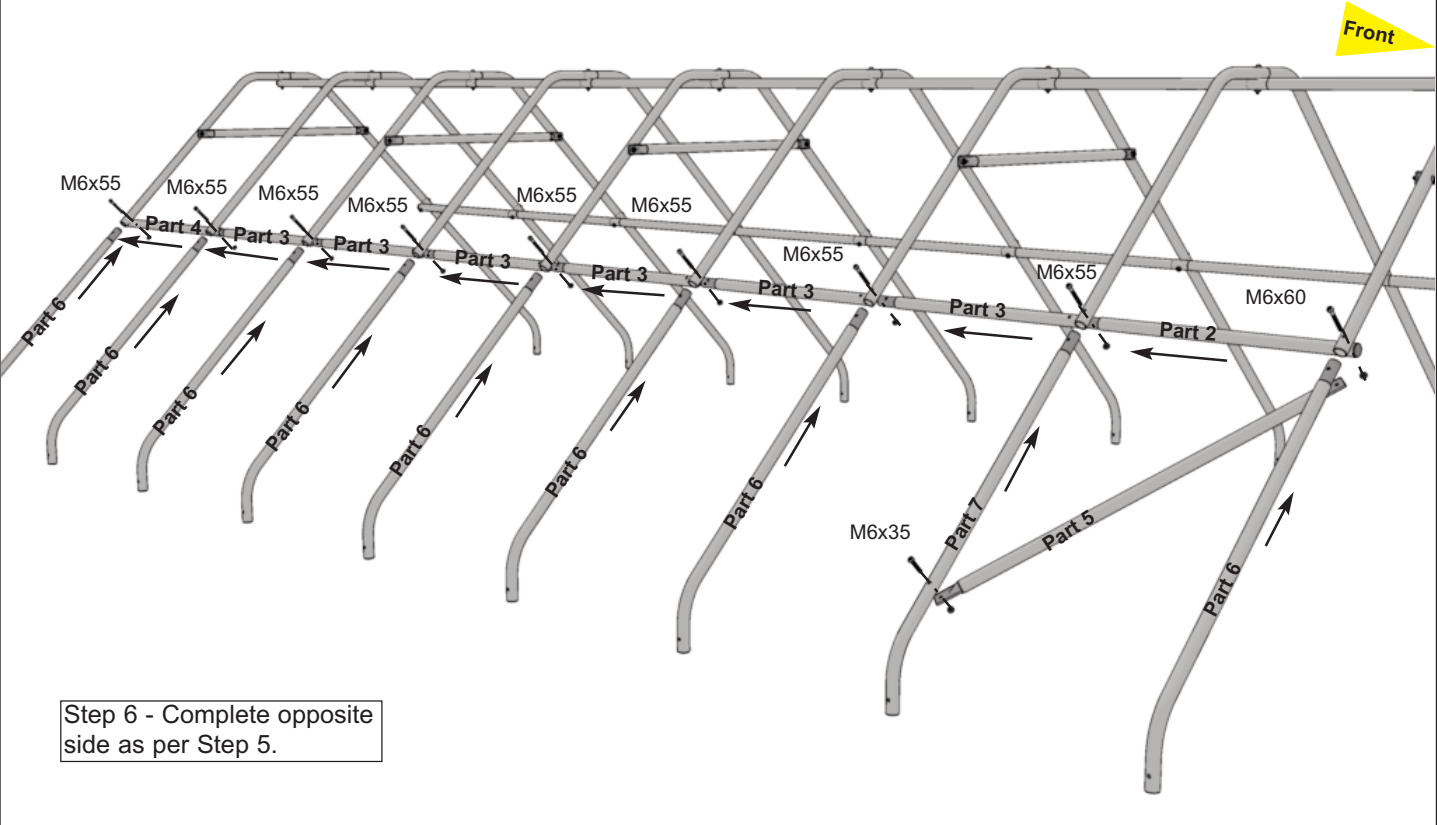

Step 6 - Complete opposite side as per Step 5.

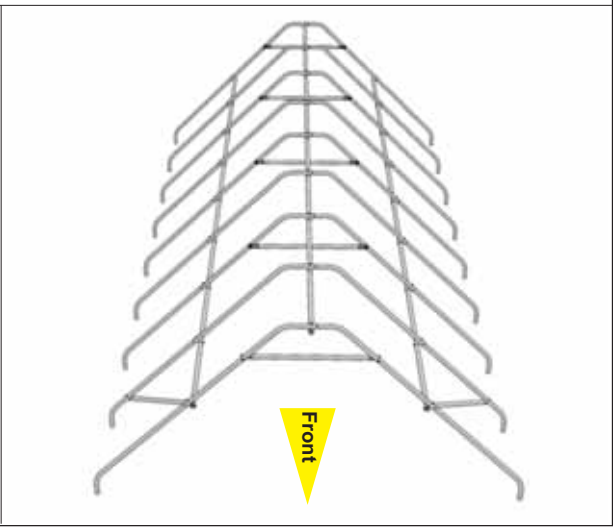
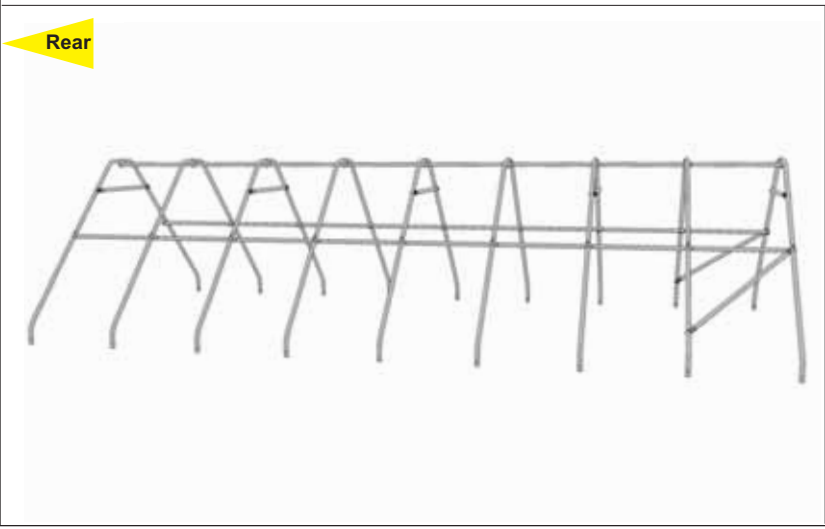

Step

7

Parts & Hardware



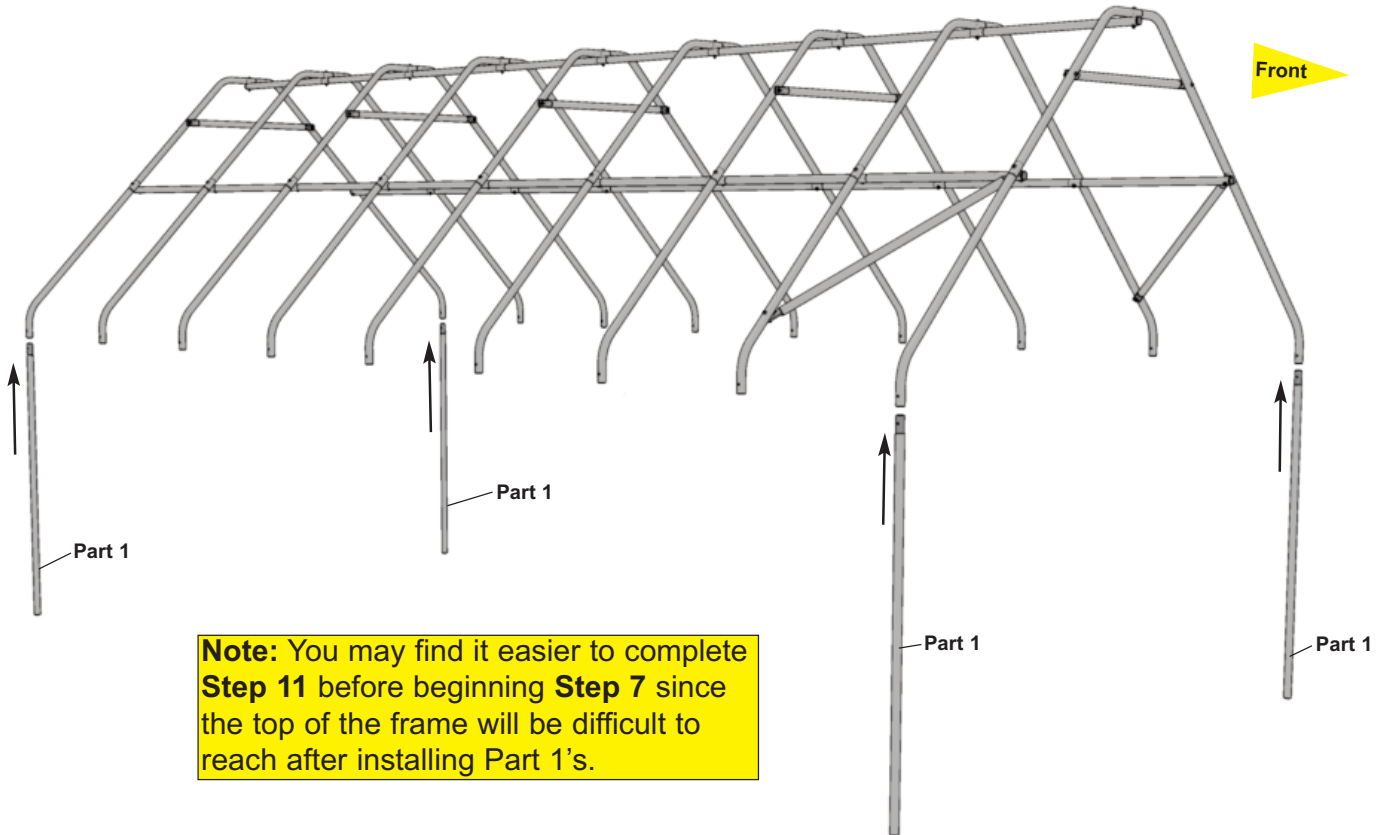

18 x Part 1

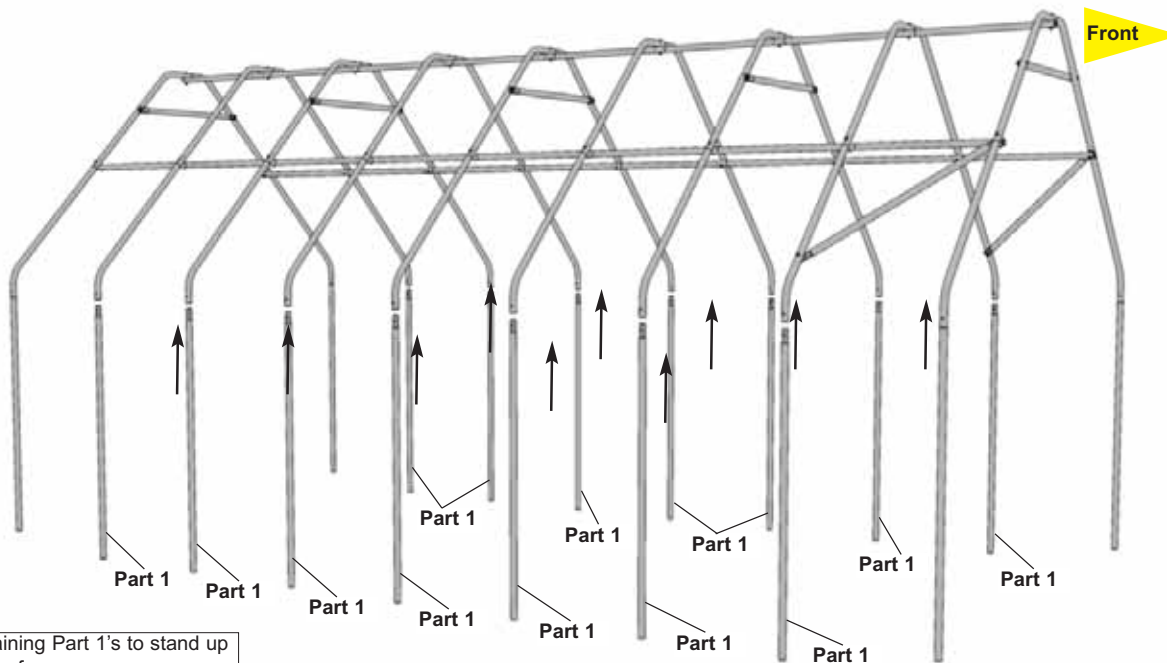

Note: You may find it easier to complete **Step 11** before beginning **Step 7** since the top of the frame will be difficult to reach after installing Part 1's.



Insert remaining Part 1's to stand up Greenhouse frame

| | | |
|-------------------------|--|--|
| Step 8 | Parts & Hardware | |
| | 12 x Part 3  | 18 x M6x55  |
| | 2 x Part 2  | 2 x Part 4  |

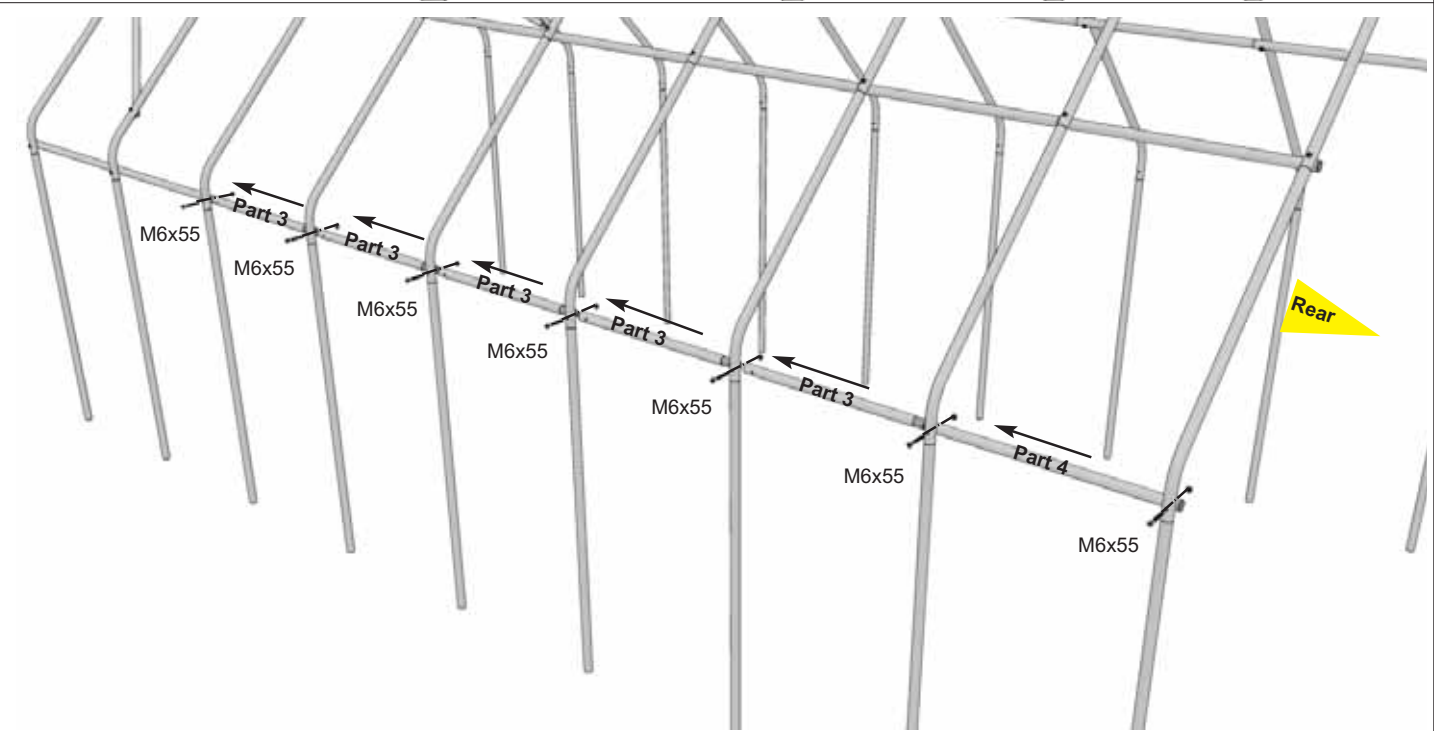
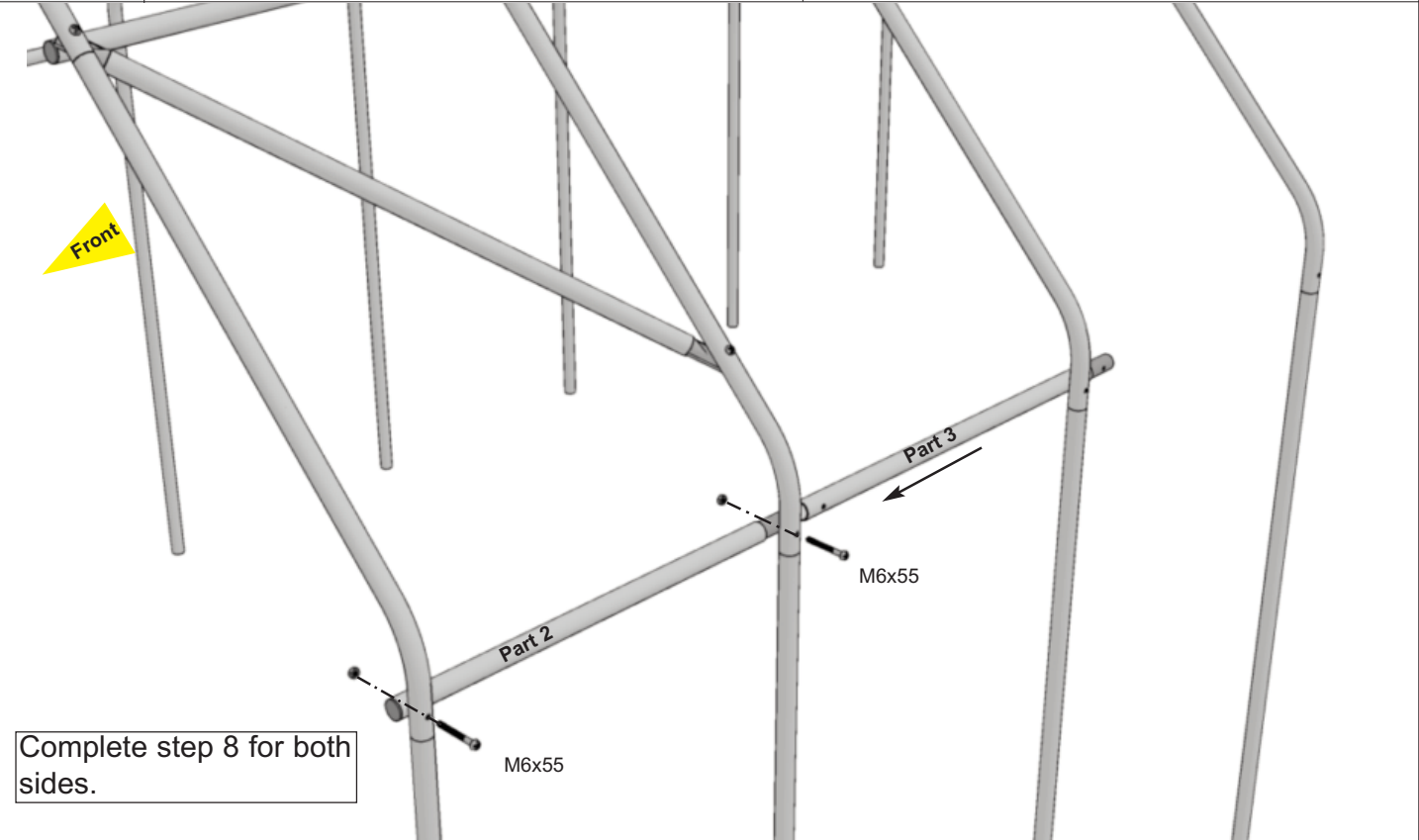

Step 9

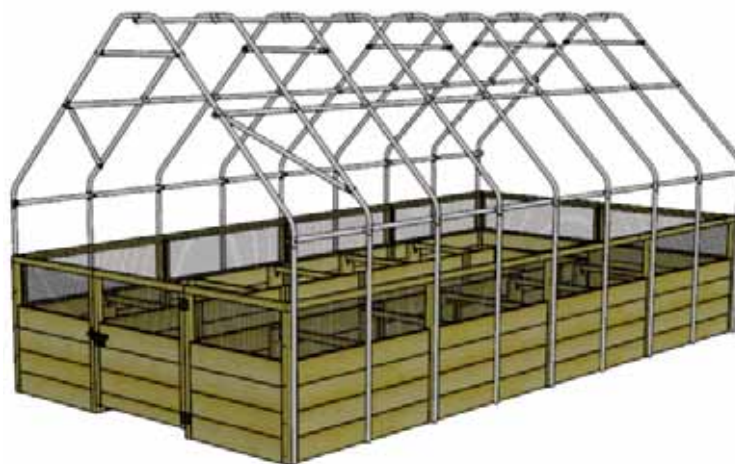
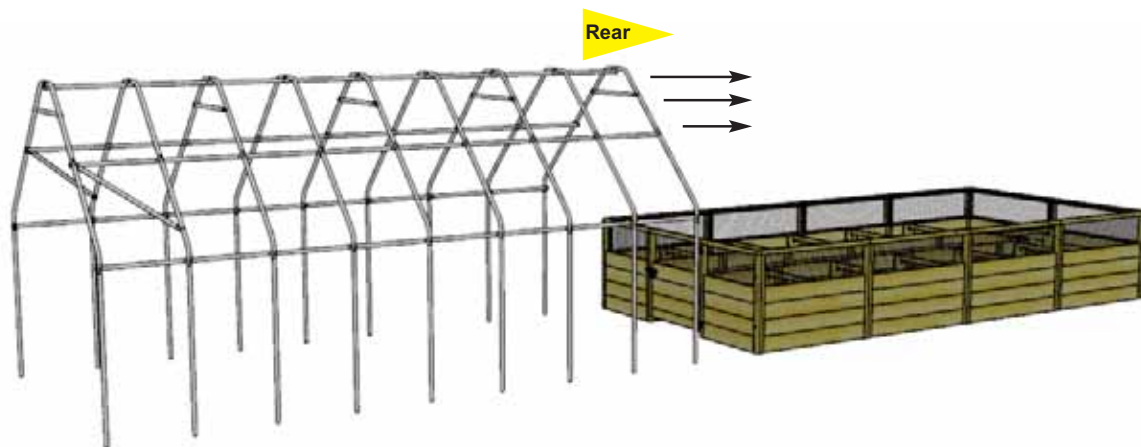

Step
10

Parts & Hardware

36 x Pipe Clamps



72 x S2 - 1 1/4" Screws

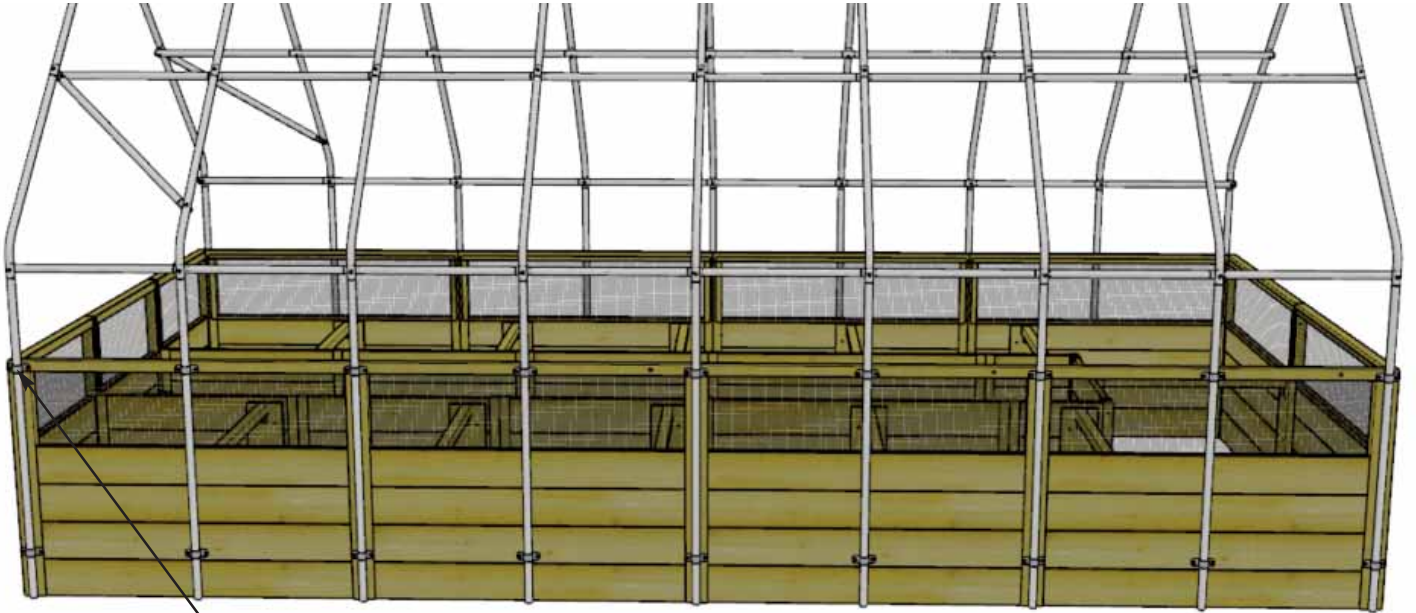

Note: Pre-drill pilot holes to prevent splitting.

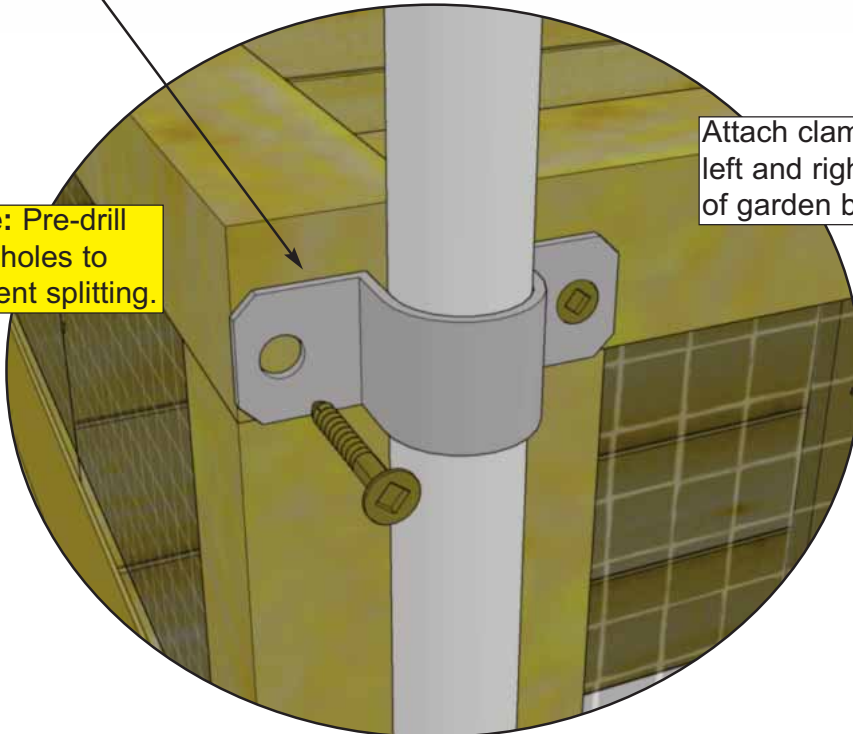

Attach clamps on left and right side of garden bed.

Step

11

Parts & Hardware



2x Protective Stripping Rolls

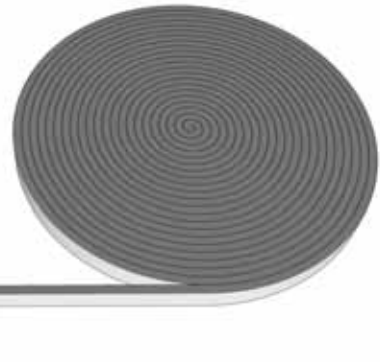

Peel off film to reveal adhesive side of protective stripping. Cover top of Greenhouse Frame with protective stripping as shown below. Start at the bottom of **Part 6** as shown. Protective stripping will prevent your frame from damaging the cover.

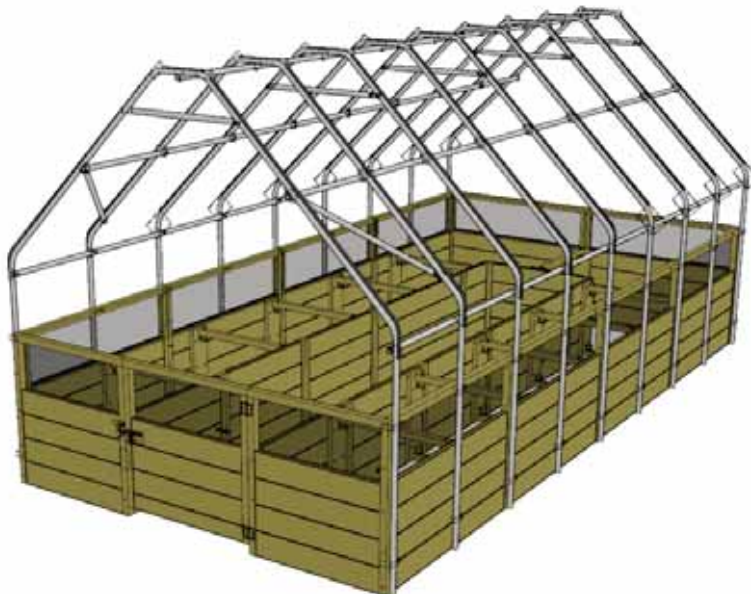
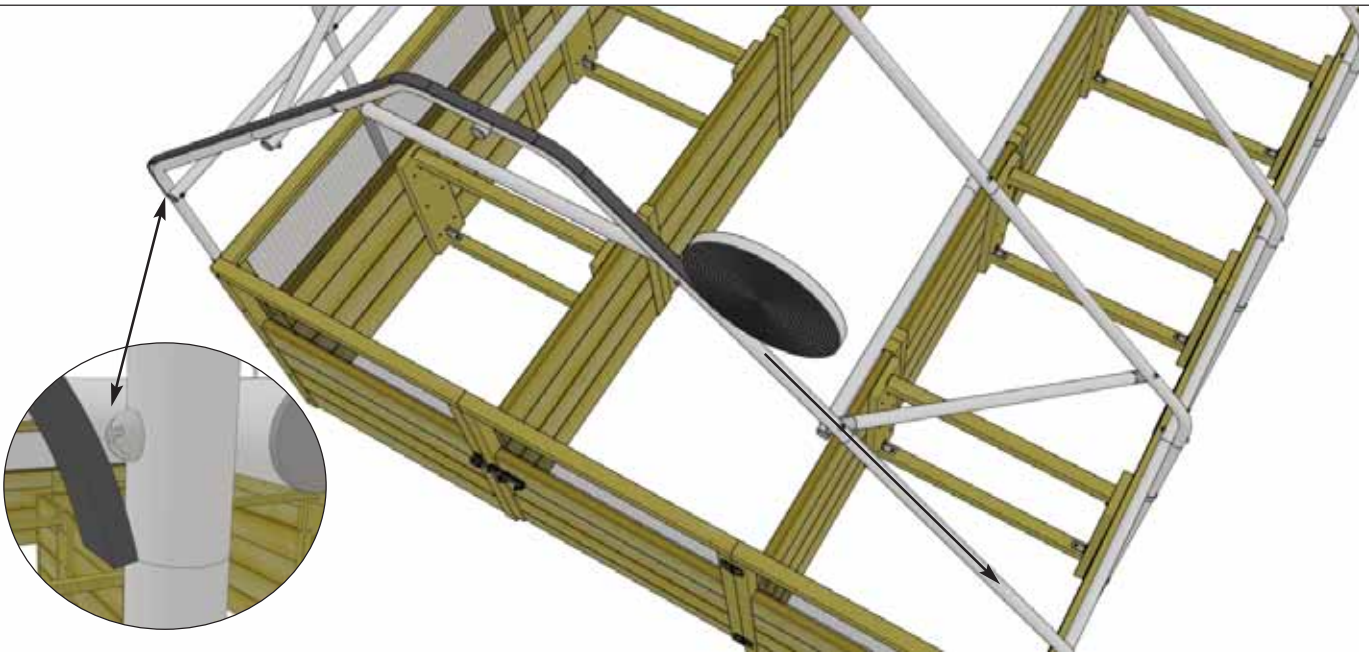

Step 12

Note: To fit the Greenhouse Cover on the frame, you will need to open the doorway of the cover.

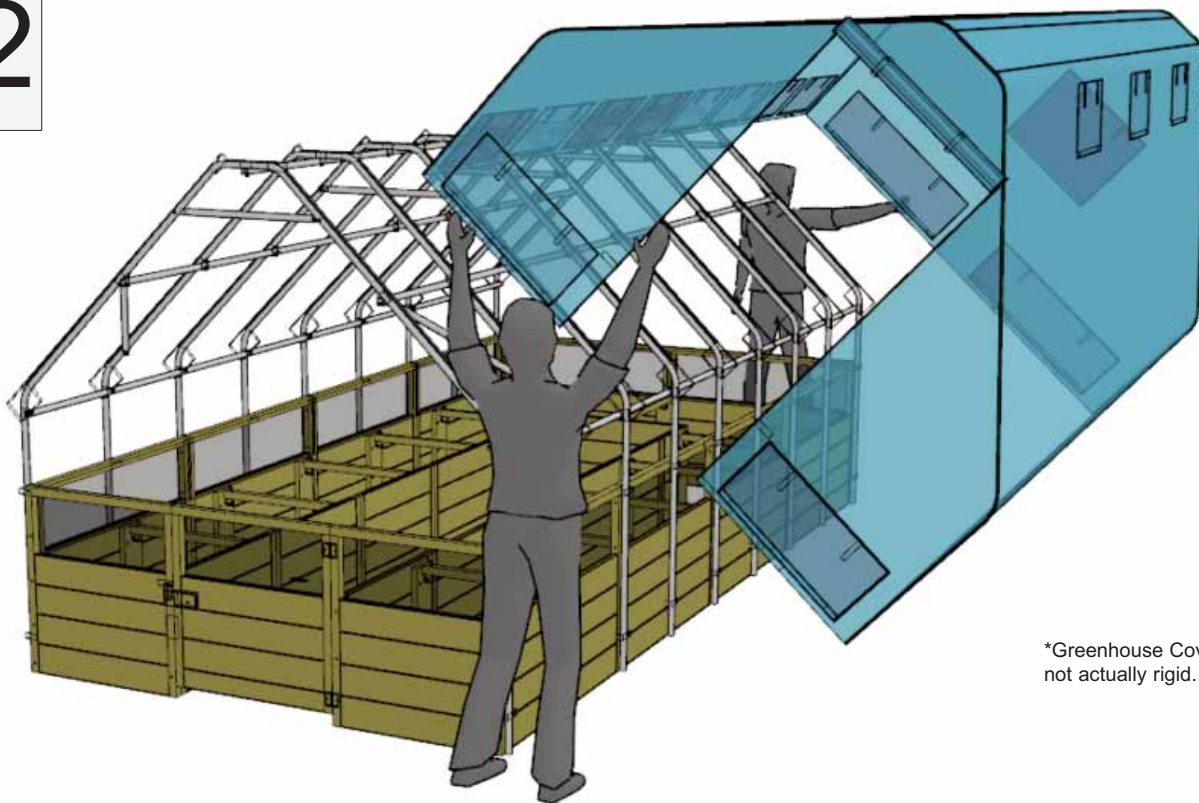

*Greenhouse Cover is not actually rigid.

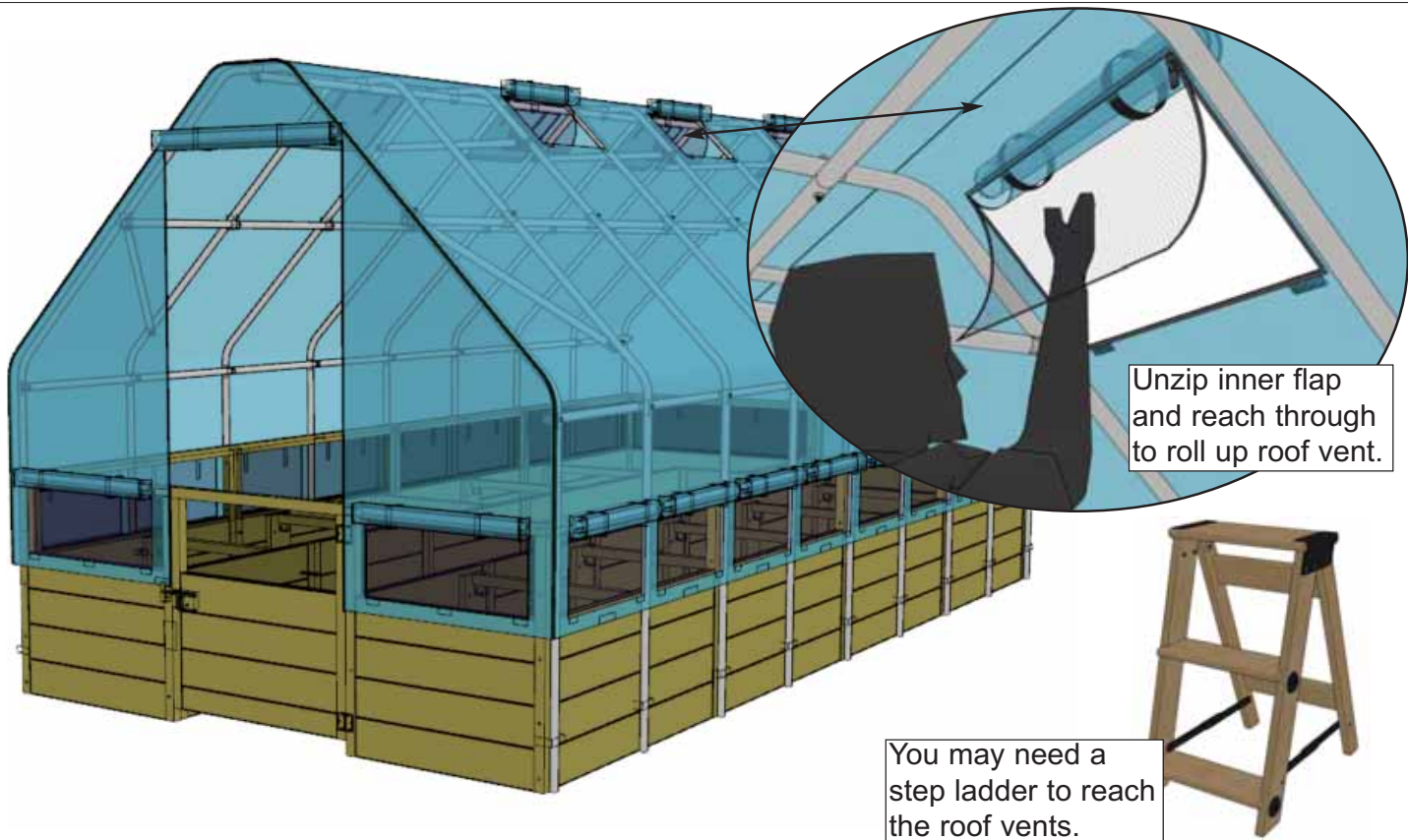

Unzip inner flap and reach through to roll up roof vent.

You may need a step ladder to reach the roof vents.

Step 13

Parts & Hardware

2 x Clips

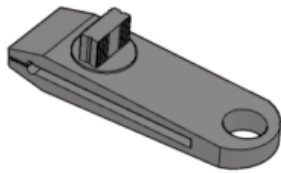

2 x 1 1/4" Pan Head Screws



2 x Washers

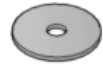

Front of Unit

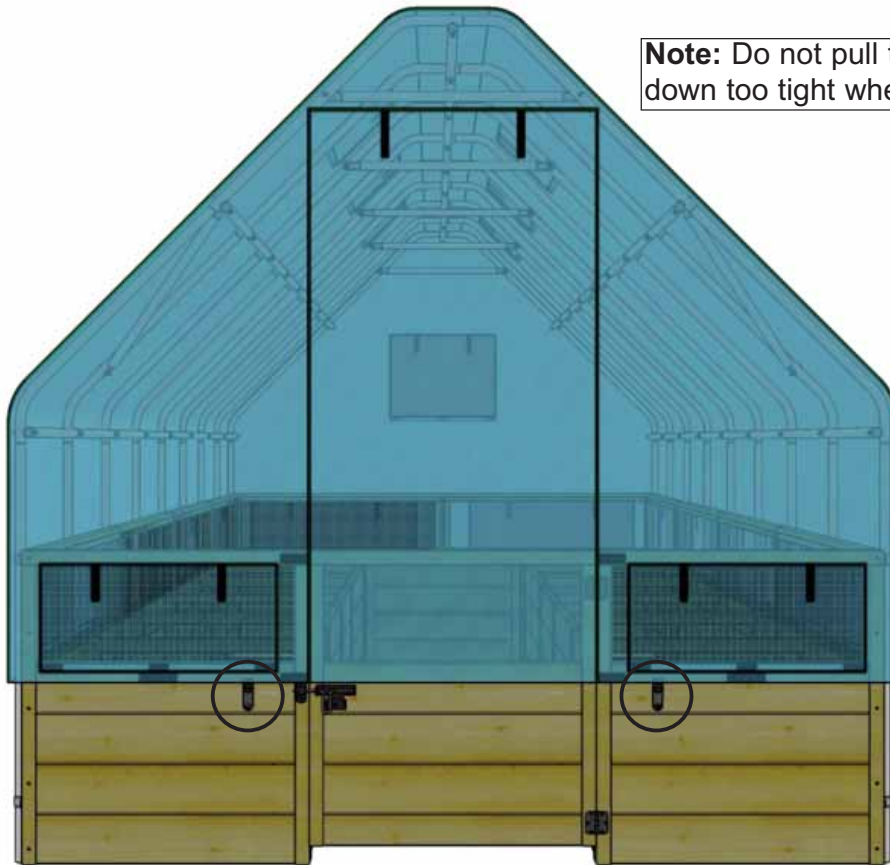

Note: Do not pull the Greenhouse Cover down too tight when attaching the clips.

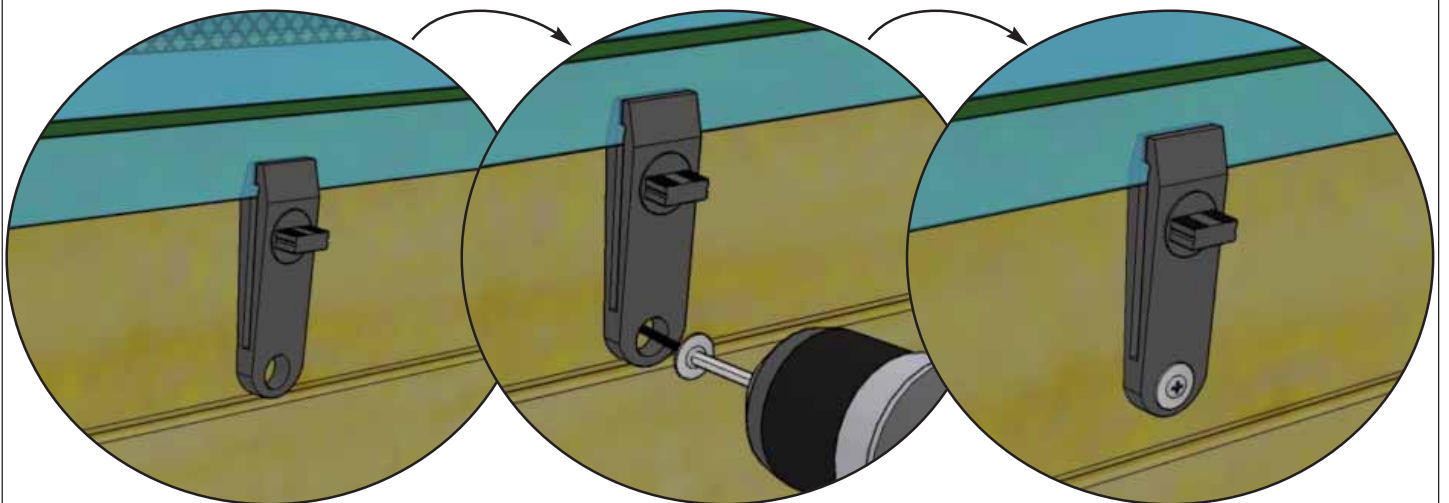

Step
14

Parts & Hardware

18 x Clips

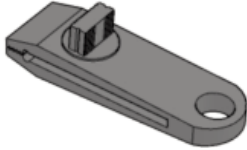

18 x 1 1/4" Pan Head Screws



18 x Washers

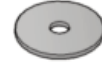

Right Side of Unit

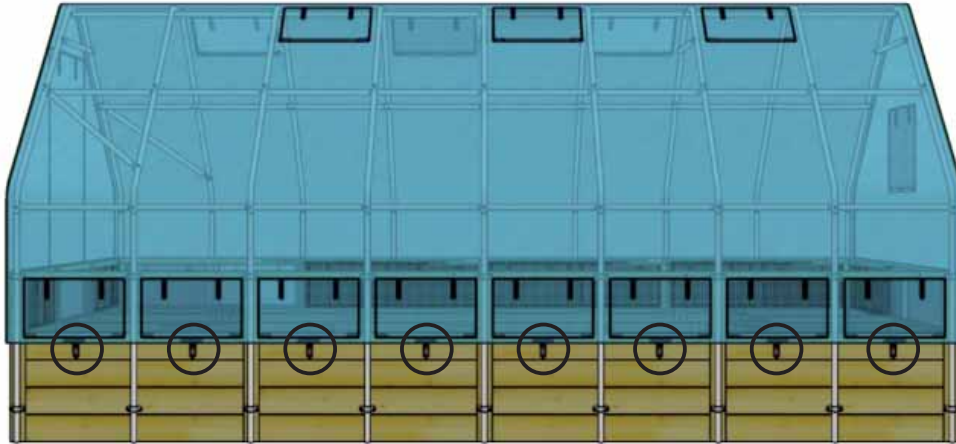

Left Side of Unit

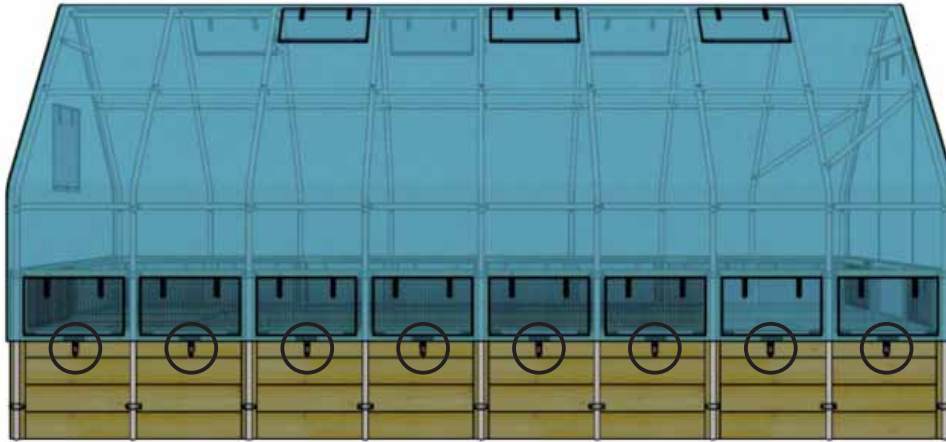

Rear of Unit

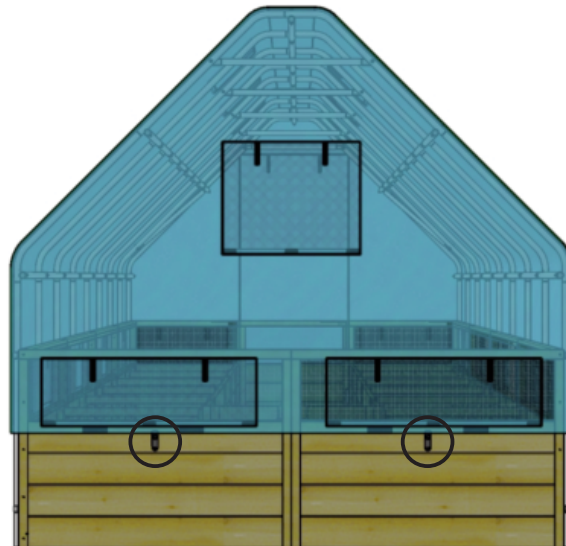



Congratulations on assembling your 8x16 Garden in a Box with Greenhouse Cover!

We hope your experience assembling your 8x16 Garden in a Box with Greenhouse Cover has been both positive and rewarding.

We value your feedback and would like to hear back from you on how well we are doing in the following areas:

1. Customer Service
2. On Time Shipping
3. Motor Freight Delivery
4. Quality of Materials
5. Assembly Manual
6. Overall Satisfaction.



Please call, write or email us at:

Outdoor Living Today

Canadian Address
9393 287th Street
Maple Ridge, British Columbia
Canada V2W 1L1

United States Address
P.O. Box 96
Sumas, Washington
USA 98295



The materials contained in this Assembly Manual may be downloaded or copied provided that ALL copies retain the copyright and any other proprietary notices contained on the materials. No material may be modified, edited or taken out of context such that its use creates a false or misleading statement or impression as to the positions, statements or actions.