



Revision #3  
March 19th, 2018

# 6'X3' Garden in a Box Trellis / Lid Kit Item# RB63T

Licensed Under U. S. PATENT No. RE44055

Thank you for purchasing a 6' x 3' Raised Garden Bed Trellis/Lid Kit. Please take the time to identify all the parts prior to assembly.

Please use Safety Eyewear and Gloves while assembling. Be sure to read and follow all operating instructions for any tools used during assembly. Remember- NO SAW CUTTING IS REQUIRED!

Safety Points and Other Considerations  
Please follow this instruction manual when assembling your Raised Garden Bed and retain the manual for future maintenance purposes.

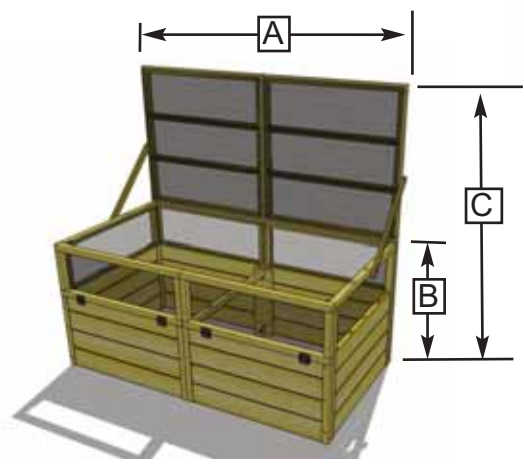
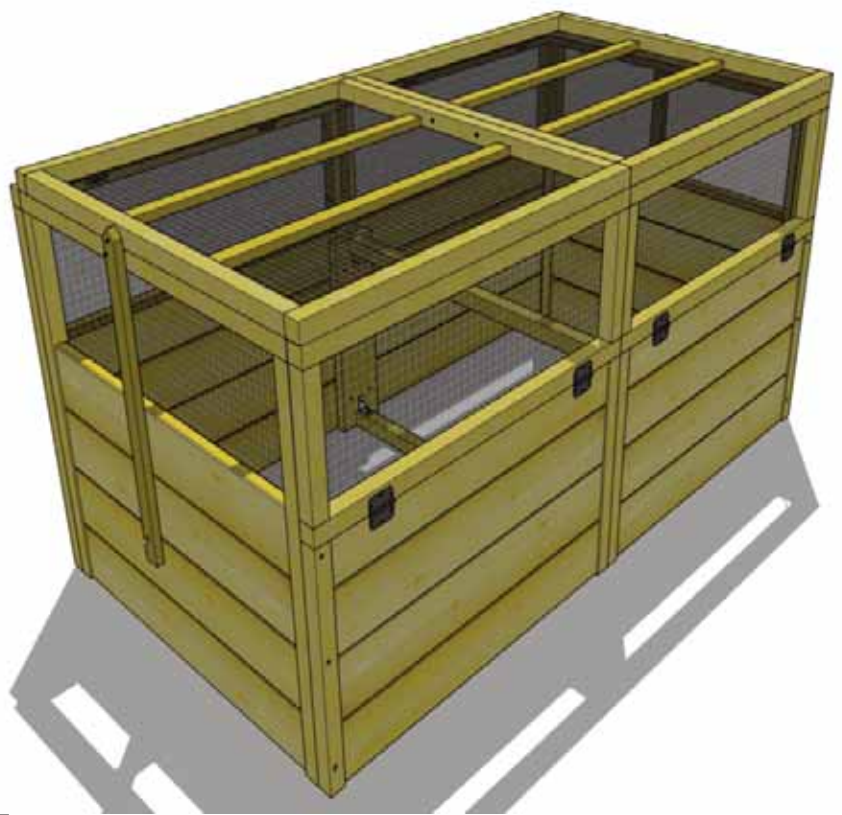

**Trellis/Lid Dimensions:**  
A: Width = 72"  
B: Height with Lid Closed = 35"  
C: Height to top of Trellis = 71"

**Estimated Assembly Time for the Lid/Trellis Option = 1/2 Hour.**

In the event of a missing or broken piece, simply call the Outdoor Living Today Customer Support Line @ 1-888-658-1658 within 30 days of the delivery of your purchase. It is our commitment to you to courier replacement parts, free of charge, within 10 business days of this notification. Replacement parts will not be provided free of charge after the 30 day grace period.

# Exploded View and Parts List for Trellis/Lid Kit

## Parts List

**Part A** 2 - Trellis/Lid Panels  
36" wide x 37 1/2" high

**Part B** 4 - Plastic Hinges

**Part C** 2 - Trellis/Lid Arms  
3/4" t x 1 1/2" w x 26" l

**Part D** 1 - Rear Trellis Cleat  
3/4" t x 2 1/2" w x 33" h

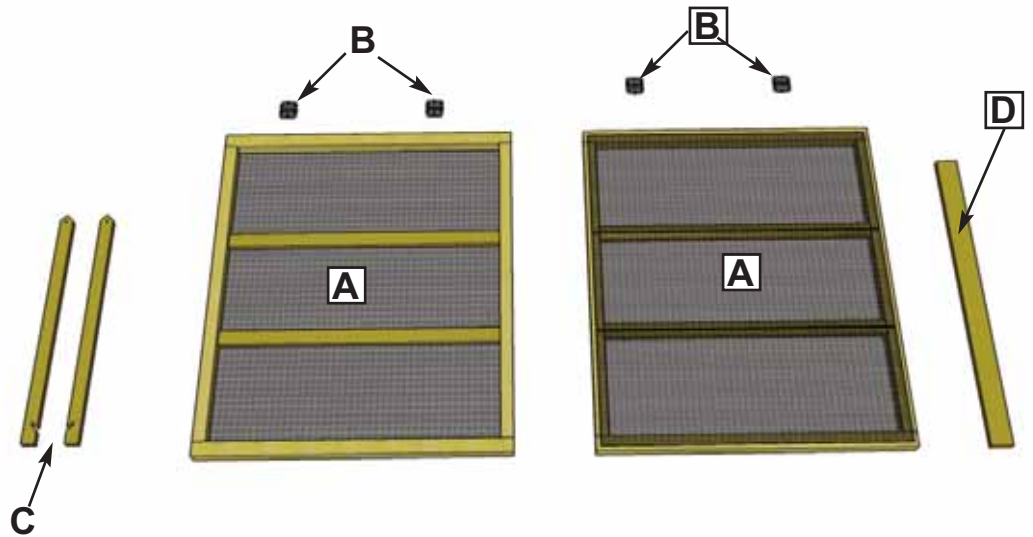

## Hardware Kit (Provided)

2"  x 12 pcs

3/4"  x 24 pcs  
Black



Trellis/Lid Arm Spacer x 2

## Tools Required (Not Provided)



Screw Gun/Drill



Tape Measure



Wood Clamp



Level



1/8" Drill Bit

## Safety Equipment Required (Not Provided)



Safety Glasses



Work Gloves



**1. Orientate Trellis/Lid Panels - Part A** (screen down) as illustrated below on flat level ground. Align so vertical framings are tight together. Use wood clamp to hold framings together.

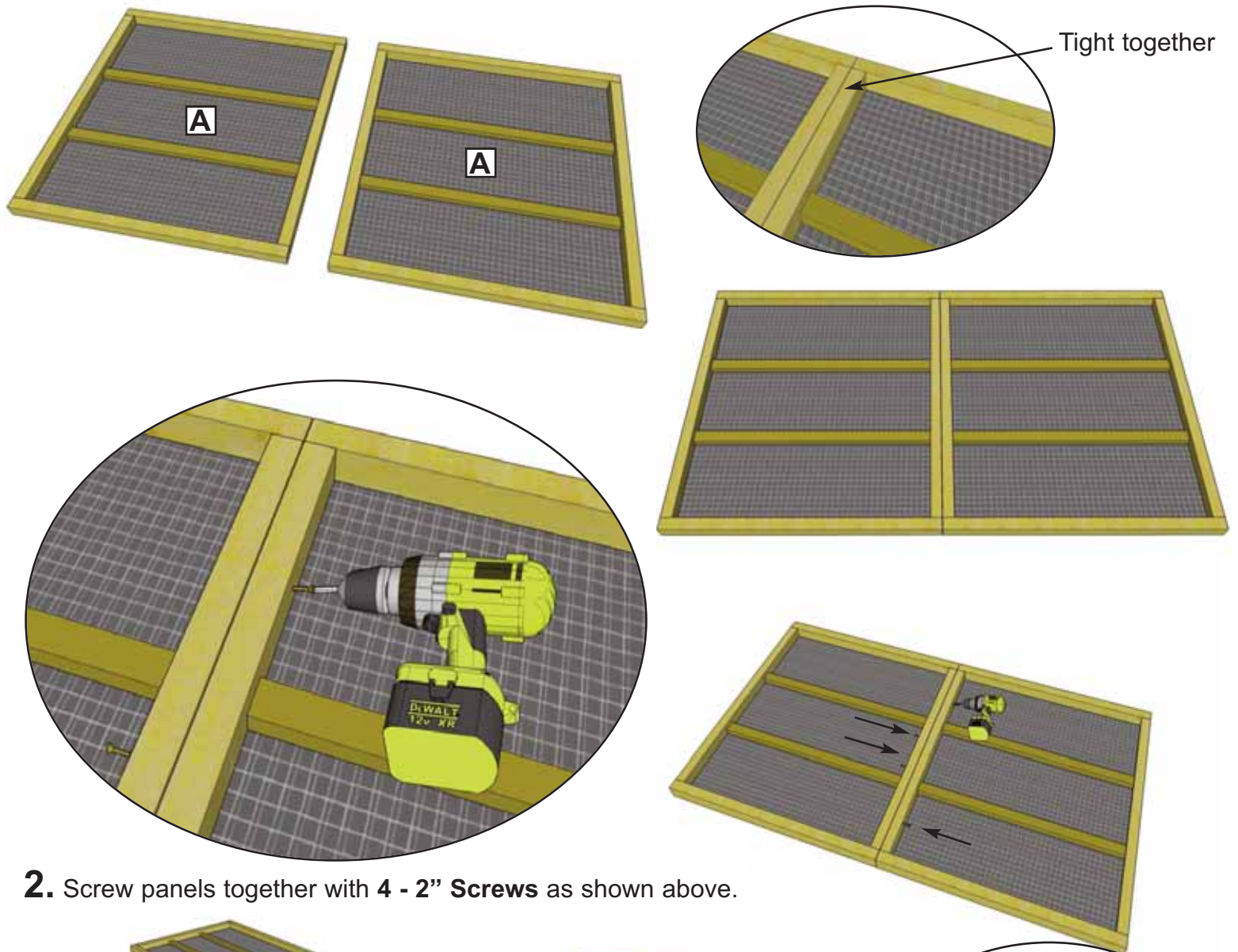

**2. Screw panels together with 4 - 2" Screws** as shown above.

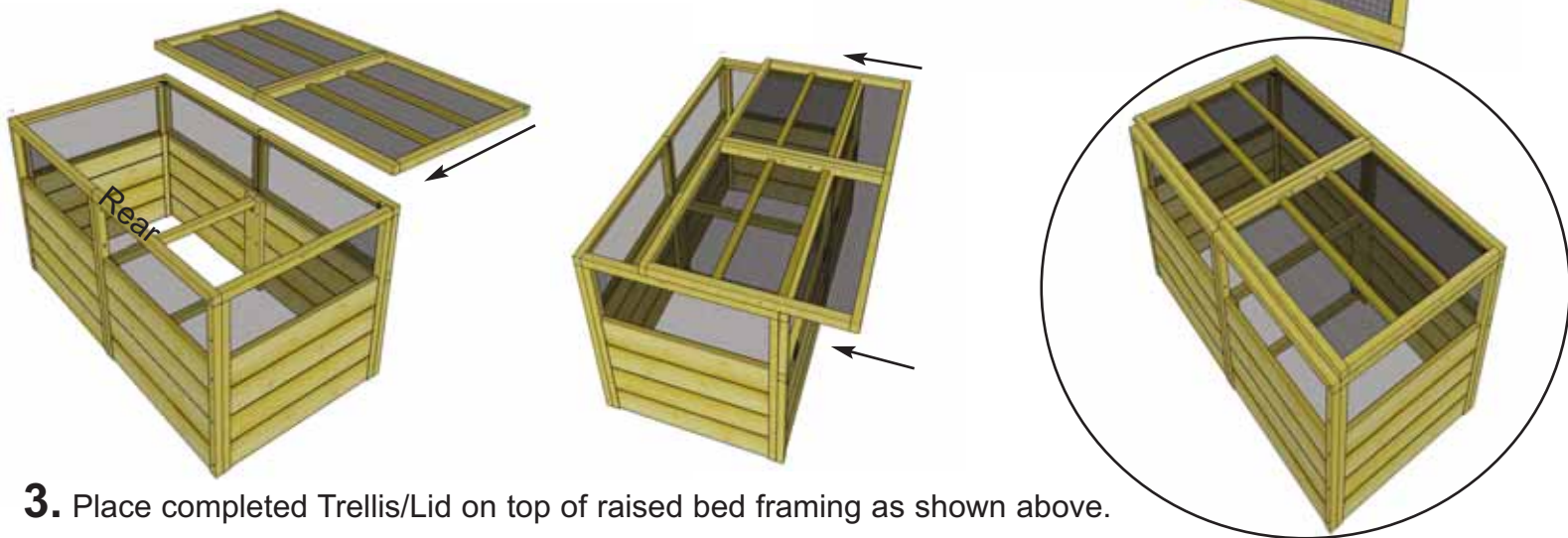

**3. Place completed Trellis/Lid on top of raised bed framing** as shown above.

**Important - If Raised Bed is not square and level, Trellis/Lid may not fit and align correctly. Before positioning, measure and align bed framing as square as possible.**



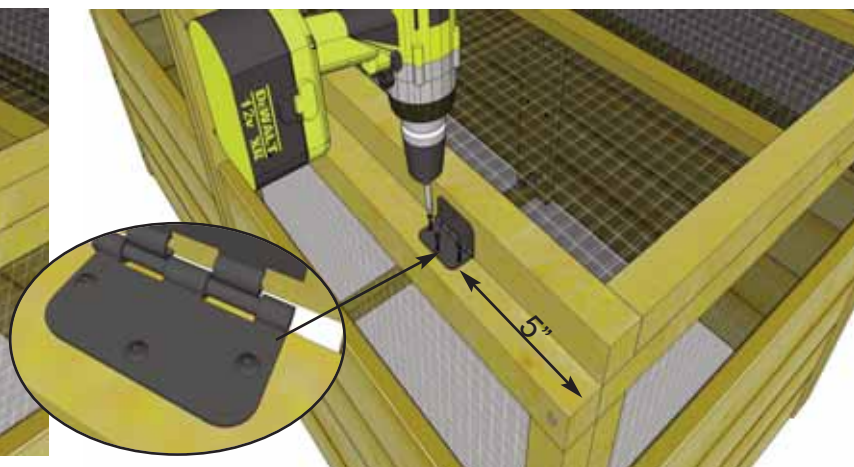
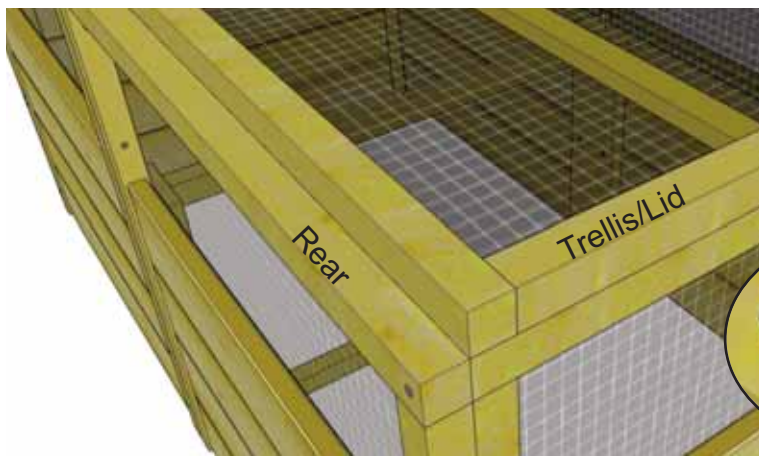

**4.** With Trellis/Lid evenly positioned on raised bed framing, locate **4 Black Plastic Hinges - Part B** and **24 - 3/4" Black Screws**. Align 1st hinge with counter sunk holes facing up. Position hinge approx. 5" from end. Attach to top framing of 6x3 raised bed with **3 - 3/4" Black Screws** per hinge. Pre-drill shallow hinge holes first with 1/8" drill bit to prevent wood from splitting. Do not over screw with cordless screw gun!

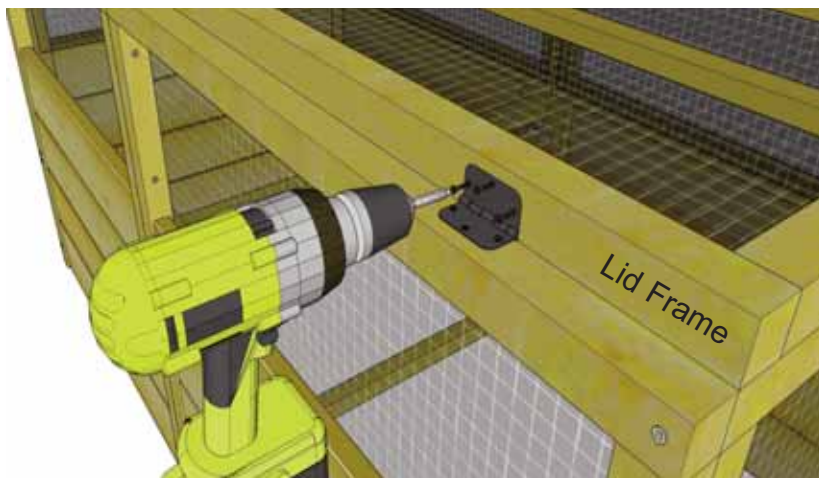

**5.** Complete attachment of 1st hinge by screwing **3 - 3/4" Black Screws** into the lid framing as shown above. Evenly space remaining hinges and attach as described previously.

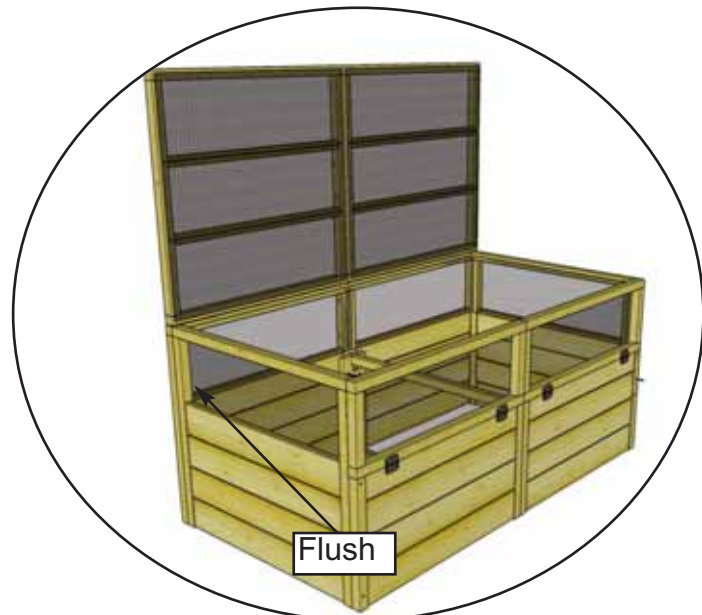

**6.** To complete Trellis/Lid installation, lift lid up and position in an upright position. You will have to hold in this position until Trellis/Lid arms are installed so an assistant would be helpful.



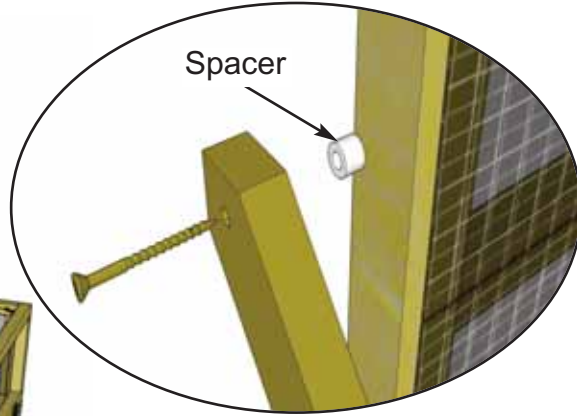
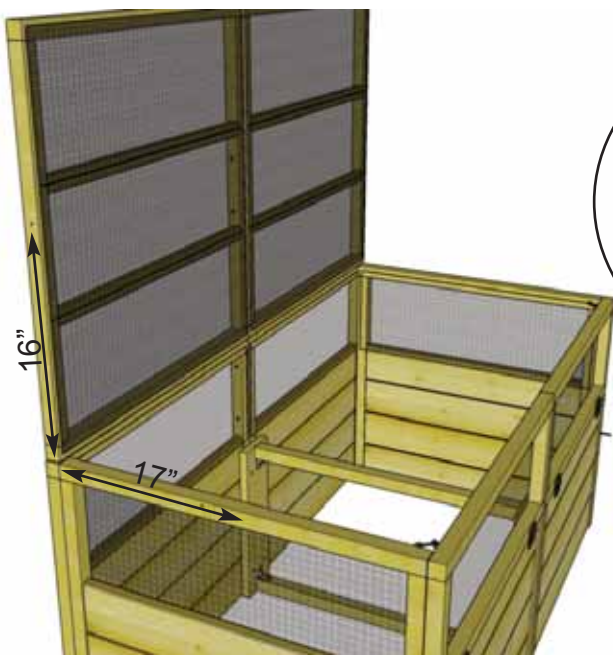

**7.** To install **Trellis/Lid Arms (C)**, measure **16"** up from **bottom** and **17"** from the **rear of panel**. Pre-drill shallow **1/8"** hole **3/8"** from top of framing to help you position arm. Locate **Trellis/Lid Arm Spacer** and position next to framing. Screw top of arm to **Trellis/Lid panel** with **1 - 2"** screw. Do not overtighten.

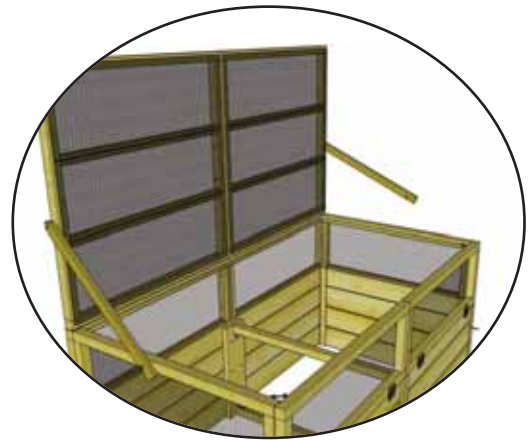
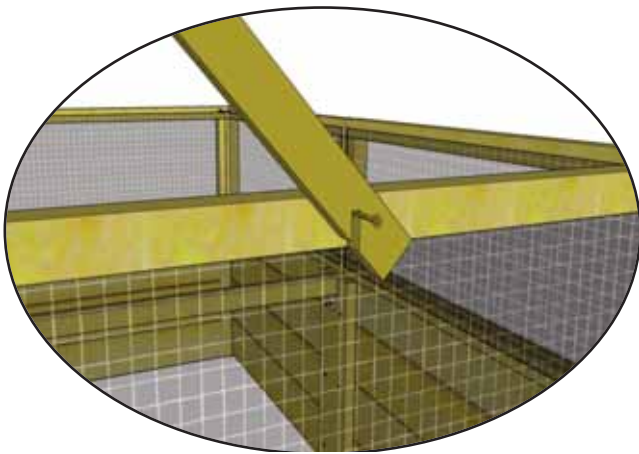

**8.** At the bottom of arm, attach a **2"** screw to a **1"** depth in previously marked location. Arm notch will rest on screw and prevent **Trellis/Lid** from closing.

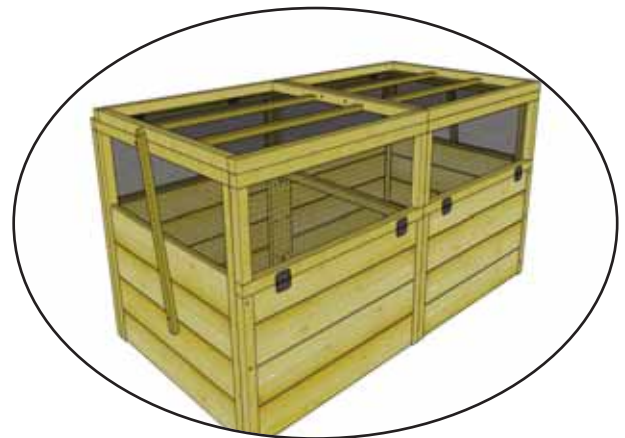

**9.** Complete remaining **Trellis/Lid Arm (C)** as per **Steps 7 & 8**.

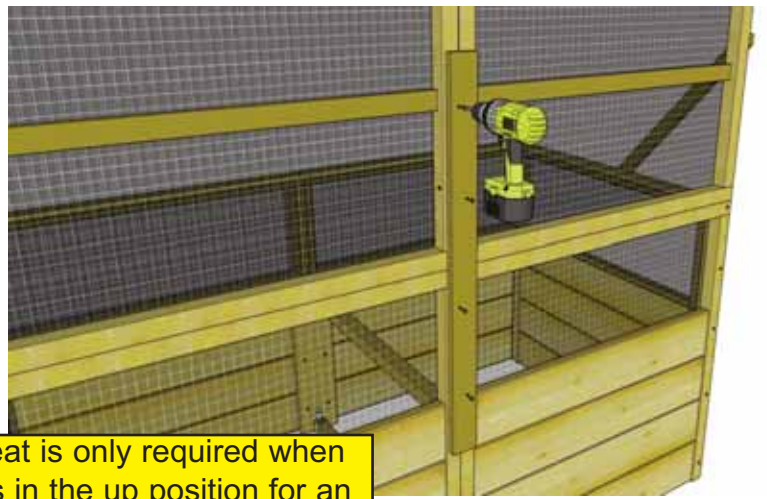
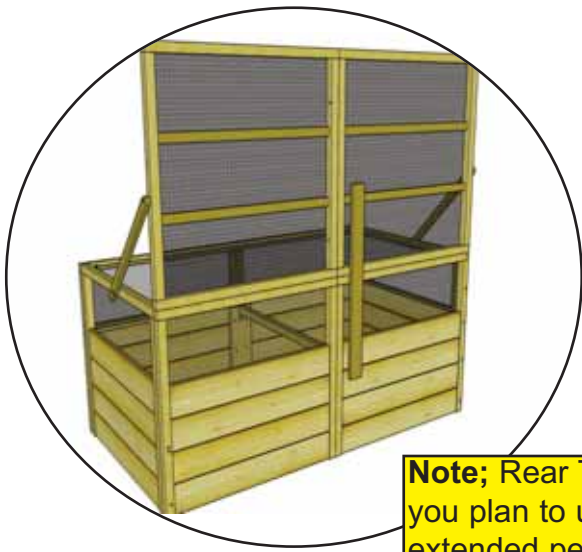

**Note;** Rear Trellis Cleat is only required when you plan to use Trellis in the up position for an extended period of time. Not required if you plan on opening and closing your lid often.

**10.** If required, locate **Rear Trellis Cleat (D)**. Center on 6x3 Raised Bed center framing and Trellis/Lid panel framing. Attach with **4 - 2" screws** slightly offset from the center. At the end of your gardening season, carefully remove screws from cleat and store to use again for the next year.



We hope your experience constructing our **6'x3' Raised Garden Bed Trellis/Lid Kit** has been both positive and rewarding. We value your feedback and would like to hear back from you on how well we are doing in the following areas:

1. **Customer Service**
2. **On Time Shipping**
3. **Motor Freight Delivery**
4. **Quality of Materials**
5. **Assembly Manual**
6. **Overall Satisfaction.**



The materials contained in this Assembly Manual may be downloaded or copied provided that ALL copies retain the copyright and any other proprietary notices contained on the materials. No material may be modified, edited or taken out of context such that its use creates a false or misleading statement or impression as to the positions, statements or actions.

Please call, write or email us at:

Canadian Address  
 9393 287th Street  
 Maple Ridge, British Columbia  
 Canada V2W 1L1

United States Address  
 P.O. Box 96  
 Sumas, Washington  
 USA 98295