



8x12 Santa Rosa Assembly Manual with Metal Roof

Version #2.5
January 24, 2022

Thank you for purchasing an 8x12 Santa Rosa Garden Shed from Outdoor Living Today. Please take the time to identify all the parts prior to assembly.



Safety Points and Other considerations:

Our products are built for use based on proper installation and normal residential use, on level ground. Please follow the instruction manual when building your Santa Rosa and retain the manual for future maintenance purposes.

Some of the safety and usage measures you may wish to consider include:

- snow load ratings vary by geographical location. If heavy or wet snowfall occurs, it is advisable to sweep the snow off the roof(s).
- if the product is elevated, any structural and building code requirements are solely the customer's responsibility, and should be abided by.
- in high or gusty wind conditions it is advisable to keep the structure securely grounded.
- have a regular maintenance plan to ensure screws, doors, windows and parts are tight.

Customer agrees to hold Outdoor Living Today Partnership and any Authorized Dealers free of any liability for improper installation, maintenance and repair.

In the event of a missing or broken piece, simply call the Outdoor Living Today Customer Support Line @ 1-888-658-1658 within 30 days of the delivery of your purchase. It is our commitment to you to courier replacement parts, free of charge, within 10 business days of this notification. Replacement parts will not be provided free of charge after the 30 day grace period.

What to do before my Shed arrives?



- Become familiar with this assembly manual and determine if you can complete the project yourself or will require a professional contractor.



- One helper is recommended to assist in constructing your shed. It generally takes two people over two days to assemble a shed. If you're hiring a contractor, their rate should be in line with that duration of work.



- Clear the construction area and ensure a clear pathway for delivery when the freight company arrives. Remove all debris: roots, grass, rocks, etc.



- Excavate the site. Contact your local utilities company to ensure there are no gas or electric lines buried in the area before digging.

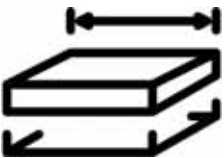

- Decide on the type of foundation you will be using:
 - Concrete slab, or
 - 4-6 inches of crushed gravel with paver stones or 4x4 stringers.

You can find the footprint for your shed on Page 3 of your Assembly Manual.



- If doing the assembly yourself, have all the necessary tools ready to go and in working condition. A list of required tools can be found after the parts list.

Foundation Types for 8x12 Garden Shed

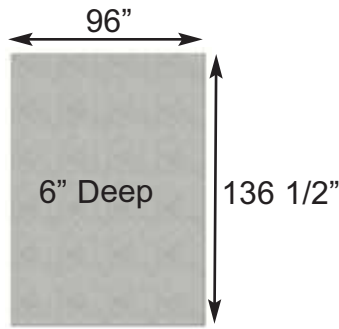

Concrete Foundation

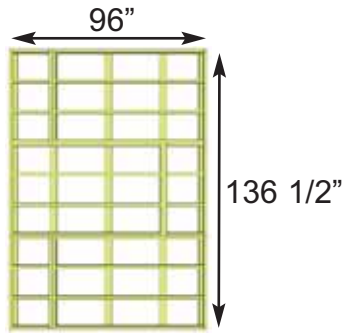

Floor Frame



Completed Foundation

Concrete Slab Foundation:

- Slab must be at least the same size as assembled floor frame (136 1/2" x 96") or larger.
- 6" Deep foundation.
- 1.7 Cubic Yards of concrete required.
- A concrete slab will have the longest durability out of your foundation options.

Once level, a concrete slab is the easiest surface to build on.

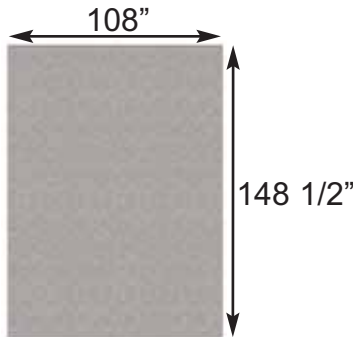

Gravel Foundation

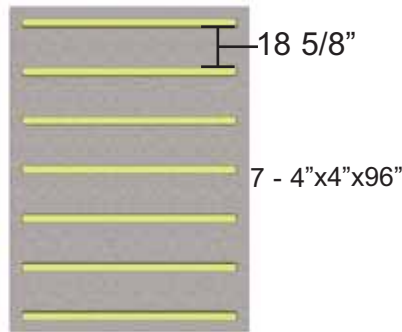

Gravel Foundation with treated stringers

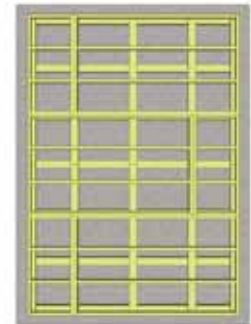

Completed Foundation

Gravel with 4x4 Pressure Treated Stringers:

- Excavate at least 6" deep, and 6" wider than floor frame on each side.
- 2.1 Cubic Yards of gravel required, approximately 19 wheelbarrows.
- 7 - 4x4 Pressure Treated Stringers 8' long required.
- Evenly spaced, with one at each end of floor frame.

Saves money on materials, easy to level and work with.

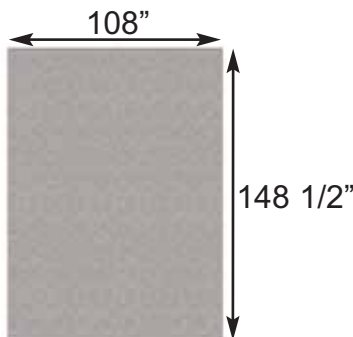

Gravel Foundation

25 Patio Stones



Gravel Foundation with Patio Pavers

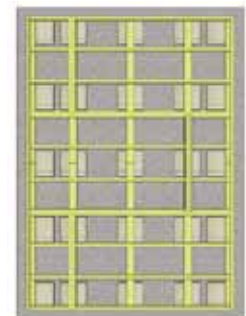

Completed Foundation

Gravel with Patio Paver Stones:

- Excavate at least 6" deep, and 6" wider than floor frame on each side.
- 2.1 Cubic Yards of gravel required, approximately 19 wheelbarrows.
- 25 patio pavers (8" x 8" or larger).
- Center patio paver stones underneath floor runners and underneath seams in floor joists.

Patio paver stones are widely available from most landscape stores.

**Thank you for purchasing our 8x12 Santa Rosa Garden Shed.
Please take the time to identify all the parts prior to assembly.**

<p>A. Floor Section Parts List - Pages 2 and 3</p> <p>Floors -----</p> <p>3 - 45 7/16" x 75" - Floor Joist Frames - Large 3 - 45 7/16" x 21" - Floor Joist Frames - Small 7 - 1 1/2" x 3 1/2" x 71 7/8" - Floor Joists 1 - 1 1/2" x 3 1/2" x 18" - Short Floor Joist 10 - 1 1/2" x 3 1/2" x 68 3/16" - Floor Runners 2 - 5/8" x 45 3/8" x 74 7/8" - Floor Plywood Large 2 - 5/8" x 45 3/8" x 20 7/8" - Floor Plywood Small</p>	<p>Steps ↓</p> <p>1 - 11</p>
<p>B. Wall Section</p> <p>Main Wall Panels -----</p> <p>4 - 45 1/2" x 75" - Solid Wall Panels 4 - 1 5/8" x 2 1/2" x 45 1/2" - Bottom Wall Plates 3 - 45 1/2" x 75" - Window Wall Panels 1 - 12" x 73" - Narrow Porch Wall Panel 1 - 2" x 3" x 45 1/2" - Door Header 1 - 1 1/2" x 3 1/2" x 73" - Door Jamb</p>	<p>Steps ↓</p> <p>12 - 19</p>
<p>Porch -----</p> <p>2 - 3/4" x 3 1/2" x 45 1/2" - Front Porch Extensions 2 - 3 1/2" x 3 1/2" x 73 7/8" - Porch Posts 2 - 1 1/2" x 4" x 74 7/8" - Front Wall Supports 2 - 1" x 5 1/2" x 44" - Outer Deck Boards 3 - 40 1/2" x 33 1/2" - Handrail Sections 4 - Corner Brackets 15 - 1" x 5 1/2" x 44 1/2" - Deck Boards</p>	<p>20 - 22</p>
<p>Top Wall Plates & Gables-----</p> <p>3 - 3/4" x 2 1/2" x 32" - Rear Top Plates (2 angle cut ends) 4 - 3/4" x 2 1/2' x 67" - Side Top Plates (angle cut edge) 2 - 3/4" x 2 1/2" x 72" - Front Top Plates Long 2 - 3/4" x 2 1/2" x 19" - Front Top Plates Short 1 - 1" x 1" x 32" - Doorway Floor Transition Strip 2 - Rear Gable Half Walls 2 - 16" long and 7 1/2" long Rear Gable Filler Shingles 2 - Middle Gable Walls</p>	<p>23 - 34</p>
<p>C. Rafter and Roof Section</p> <p>Rafter & Roof Assembly-----</p> <p>2 - 3/4" x 4 1/2" x 84" - Ridge Board Long 2 - 3/4' x 4 1/2" x 52 1/2" - Ridge Board Short 18 - 1 1/2" x 3 1/2" x 56 1/2" - Rafters 4 - 1/2" x 4 1/2" x 68 1/4" - Soffits 2 - 3/4" x 3 1/2" x 72" - Roof Gussets 16 - 3/4" x 3 1/2" x 49 1/4" - Roof Battens Outside 8 - 3/4" x 3 1/2" x 45 1/2" - Roof Battens Inside 12 - 3/4" x 1 1/2" x 14 1/8" - Batten Spacers 8 - 39 1/2"wide x 61"long - Metal Roof Panels 3 - 60" long - Metal Ridge Caps Several Pcs - Foam Enclosures for Metal Roof</p>	<p>Steps ↓</p> <p>35 - 66</p>
<p>D. Trim & Micellaneous Section Part 1</p> <p>2 - 1/2" x 3 1/2" x 44" - Horizontal Above Door Trim 2 - 1/2" x 44 1/2" x 48 1/2" - Porch Ceiling Panels 2 - 1" x 1" x 45 1/2" - Porch Ceiling Support Strips 2 - 1/2" x 4 1/2" x 48" - Front Bottom Skirting 2 - 1/2" x 4 1/2" x 44 1/2" - Porch Side Bottom Skirting 6 - 3/4" x 4 1/2" x 45 1/4" - Rear/Side Bottom Skirting - Bevel 4 - 3/4" x 1 1/2" x 45 1/4" - Top Wall Trim - Bevel</p>	<p>67 - 81</p>

Parts list continued...

<p>Continued</p> <p>2 - 7/8" x 2 1/2" x 75" - Rear Filler Trims 2 - 1/2" x 3 1/2" x 78 1/2" - Corner Trims 2 - 1/2" x 5 1/2" x 81 1/2" - Wide Corner Trims 2 - 7/8" x 1 1/2" x 78 1/2" - Narrow Filler Trims 4 - 1/2" x 2 1/2" x 78 1/2" - Narrow Trims 1 - 1/2" x 2 1/2" x 77 1/2" - Rear Wall Seam Trim 2 - 1/2" x 2 1/2" x 72" - Porch & Door Trims 2 - 1/2" x 2 1/2" x 45 7/8" - Porch Roof Seam Trims 1 - Small Porch Detail Plate 3 - Facia Detail Plates</p>	<p>Parts List - Page 3</p> <p>67 - 70</p>
<p>E. Trim & Miscellaneous Part 2</p>	<p>Steps ↓</p>
<p>Facia -----</p> <p>4 - 3/4" x 2 1/2" x 53" - Roof Nailing Strips 2 - 1/2" x 5 1/2" x 23 1/4" - Front Post Detail Covers 1 - Gusset Gable 4 - 3/4" x 3 1/2" x 58" - Front & Rear Facia 4 - 3/4" x 3 1/2" x 71 3/4" - Side Facia 2 - 3/4" x 4 1/2" x 43 3/8" - Horizontal Gable Trims - Bevel 1 - Large Detail Plate 2 - Pentagon Detail Plate</p>	<p>82 - 90</p>
<p>Miscellaneous -----</p> <p>4 - 3 1/2" x 3 1/2" x 42" - Short Deck Post with Ball 21 - Cedar Ridge Cap 1 - Short Cedar Ridge Cap 3 - Window Insert 3 - Window Trim Package 1 - Dutch Door with Hardware (Top & Bottom) 2 - Shim Shingle 1 - 1/2" x 2 1/2" x 35 1/4" - Horizontal Door Stop 2 - 1/2" x 2 1/2" x 72" - Vertical Door Stops 12 - 1/2" x 1 1/2" x 4" - Post Base Trims 3 - 1 1/2" x 3 1/2" x 3 1/2" - Handrail Support Blocks 3 - Flower Box Kits</p>	<p>91 - 103</p>

Note: All Trim, Facia and Bottom Skirting pieces will be positioned rough face out when installed.

Advice: Wood has a tendency to split when screwing near the ends of a board. To prevent splitting, it is always recommended to pre-drill pilot holes before screwing into these areas.



8x12 SANTA ROSA - METAL ROOF HARDWARE SHEET

Hardware Kit (Provided)

2 1/2"  x 260

2"  x 235

2"  x 35
Black Headed

1 1/4"  x 350

3/4"  x 27
Silver

3/4"  x 23
Black Headed

1 1/2"  x 5
Shingle

1 1/2"  x 465
Finishing

1/4"x 2"  x 52
Metal Roof Screw

 x 1
1/4" Nut Driver

 x 2
Square Drive Bit

 Tee Hinge x4

 Pull Handle

 Metal Roof Hanger x4

 Single Rafter Bracket x 4

 Double Rafter Bracket x 2

 Interior Barrel Bolt

 Black Drop Latch

 Silicon Caulking (1)

 Ridge Board Connector x 2

Tools Required (Not Provided)

 Hammer

 Screw Gun/Drill

 Tape Measure

 Wood Clamp

 1/8" Drill Bits

 Level

 Pliers

 Ladder

Safety Equipment Required (Not Provided)

 Safety Glasses

 Work Gloves

Before/During Assembly:

- 1.) Paint each face and edge of your plywood floor with a latex exterior paint.
- 2.) Caulk wall seams if gaps appear.
- 3.) Caulk around window framing.
- 4.) Caulk perimeter between floor plywood and bottom wall plate.
- 5.) Caulk channels in lap siding at the top of your door above the trim, just a drop in each channel.
- 6.) Caulk edge of door threshold (if applicable).
- 7.) Optional: Install a Sill Gasket between floor runners and foundation.
- 8.) Optional: Install an 8" strip of roofing paper below Cedar Ridge Caps for Cedar Roof Sheds.

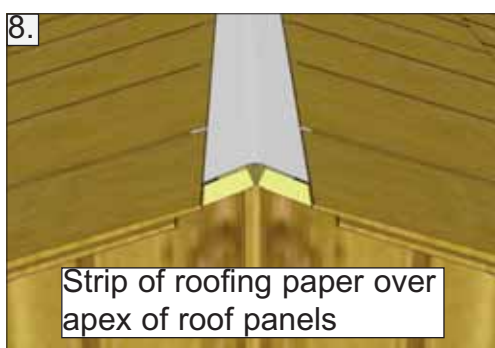
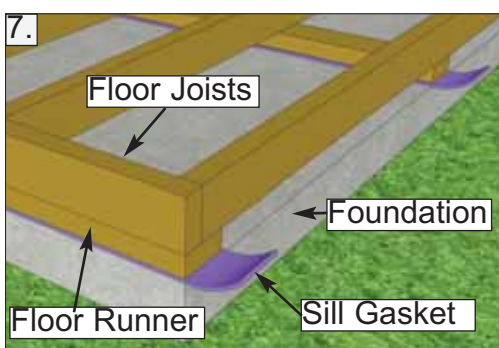
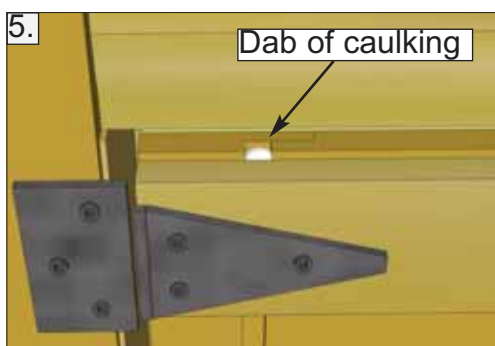
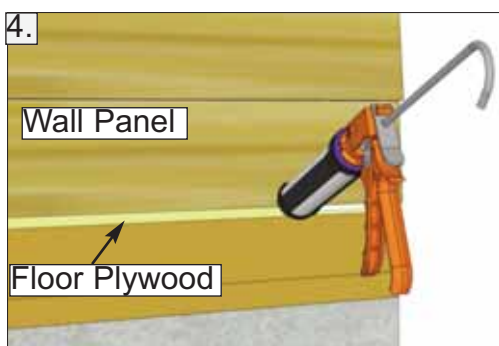
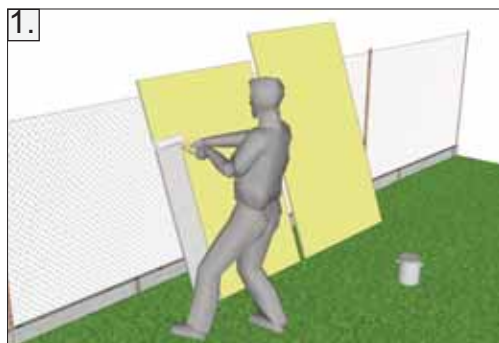

Routine Maintenance:

- Routinely check all fasteners are tight (ex. Door Hinges, Nails)
- Brush off dirt from walls.
- Brush off snow from roof regularly.
- Routinely remove needles and leaves from roof.

Painting/Staining

- Your cedar shed, if left untreated, will weather to a silvery grey colour.
- Painting or staining your structure is highly recommended and will prolong the life of your shed.
- You do not need to wait to paint or stain your shed, the wood in your kit has been dried and can be stained or painted immediately.
- Consult your local paint store for the best paint or stain for cedar.
- Optional: stain the inside of your shed. (Note: this will remove the fresh cedar smell.)

A. Floor Section

Exploded view of all parts necessary to complete Floor Section. Identify all parts prior to starting.
 Note: Floor Footprint is 136 1/2" deep x 96" wide.

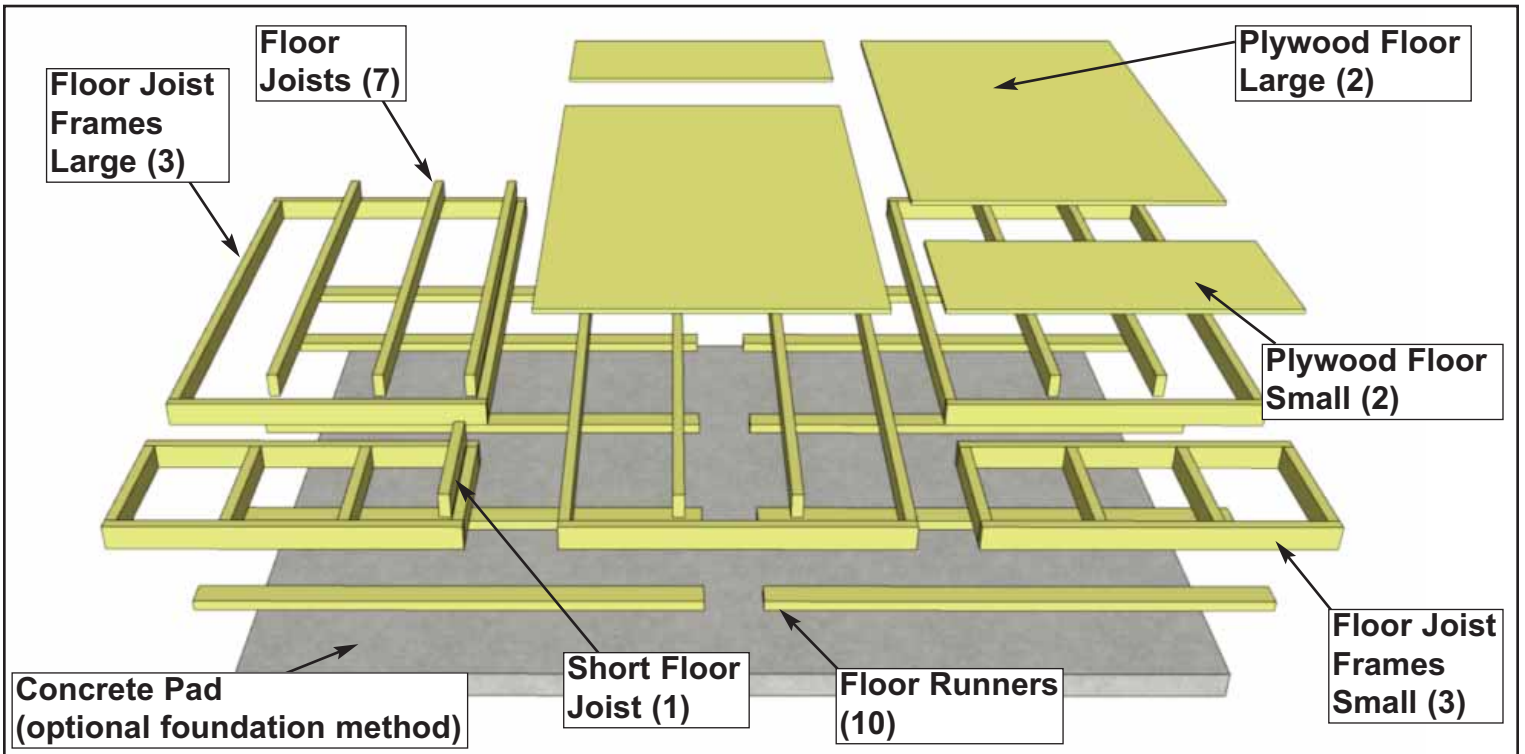

Flush with framing



1. Lay out **Large Floor Joist Frame** and **2 Floor Joists** as illustrated above. Position Joists equally in Floor Joist Frame. Use **Small Floor Joist Frame** as a template to determine joist position. Position Joist so flush with framing.

Parts (Steps 1 - 2)
Floor Joists
 (1 1/2" x 3 1/2" x 71 7/8") x 6
Large Floor Joist Frame x 3

Hardware (Steps 1 - 2)
S1 - 2 1/2" Screws
 x 24 total

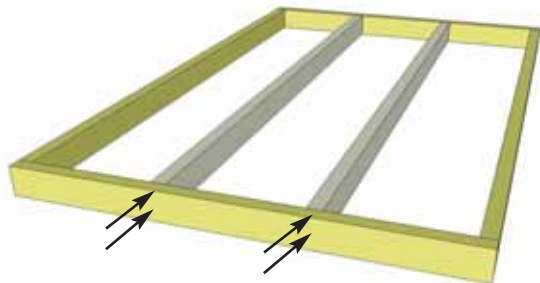

You can find the Square Drive Bit for the screws in with the Hardware Kit Bag.



2. When correctly positioned, attach each Joist with **4 - 2 1/2" screws** (2 per end). **You can find the Square Drive Screw Bit in the Hardware Kit Bag.**

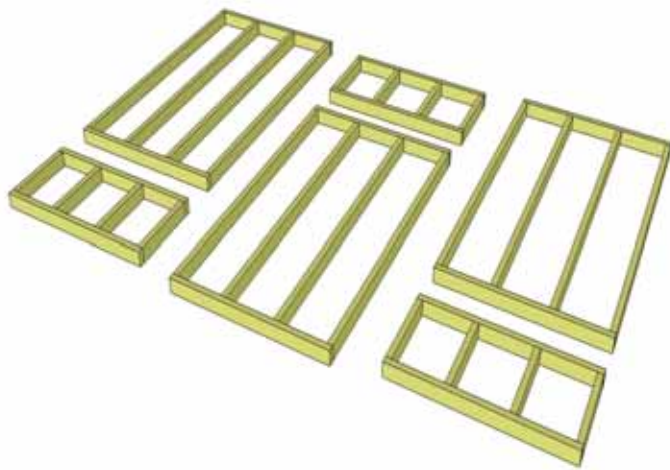

3. Lay out **Floor Joist Frames** as illustrated. There are 3 larger and 3 smaller Frame Sections. The Footprint for the floor when attached together will be 136 1/2" Deep x 96" Wide.

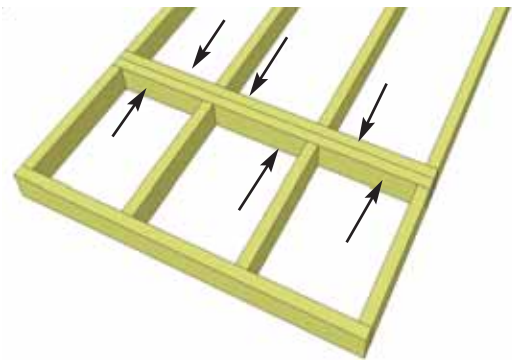

4. Attach each large and small floor joist frames together with **6 - 2 1/2" screws** per section.

Hardware (Step 4)
S1 - 2 1/2" Screws
 x 18 total



5. Complete all large and small frame attachments. Screw each completed section together with **8 - 2 1/2" screws**.

Hardware (Step 5)
S1 - 2 1/2" Screws
 x 16 total

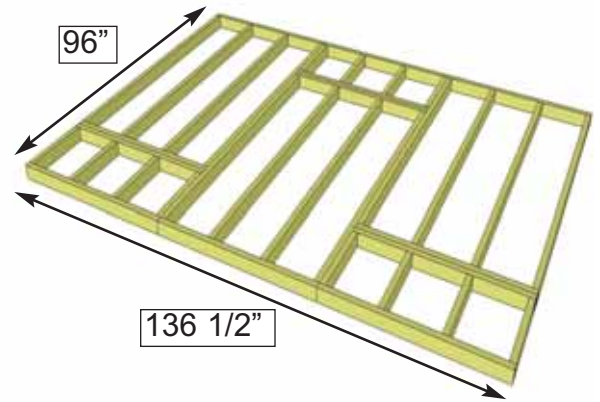

6. When completed, your floor footprint should be 136 1/2" Deep x 96" Wide.

Material used for Floor Runners are not graded for appearance. Some defect is allowed.

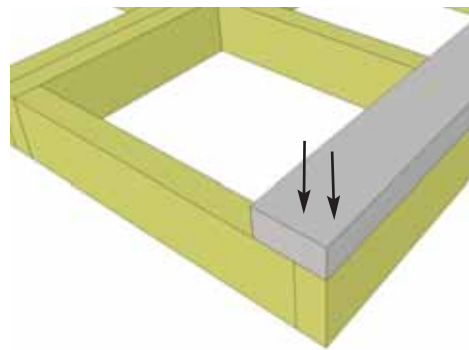
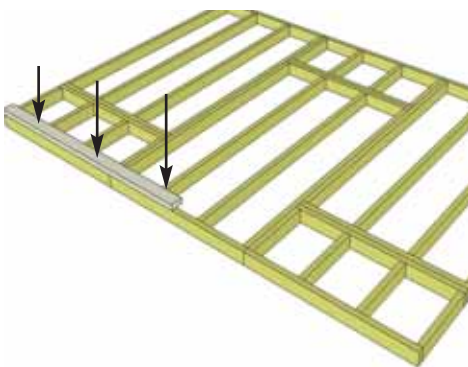

7. Attach **Floor Runners** to completed floor frame. There are 2 floor runners per 136 1/2" side and 5 completed runners in total. Use **6 - 2 1/2" screws** per completed Runner. Make sure Runners are flush with edge of floor framing, but not overhanging.

Parts (Steps 7)
Floor Runners
 (1 1/2" x 3 1/2" 68 3/16") x 10
Hardware (Steps 7)
S1 - 2 1/2" Screws
 x 30 total

Note: The floor will be flipped over and floor runners will sit on your foundation. It is important to note that having a level foundation is critical. Choosing a foundation will vary between regions. Typical foundations can be concrete pads or patio stones positioned underneath the floor runners.

8. With Floor Runners attached, carefully flip the floor over and place on your foundation. **Caution:** you will need 2 people to assist you. Be careful when laying floor down not to bend or twist it. When in place, level floor completely.

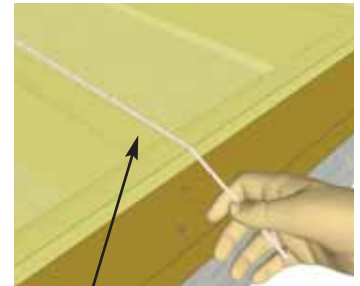
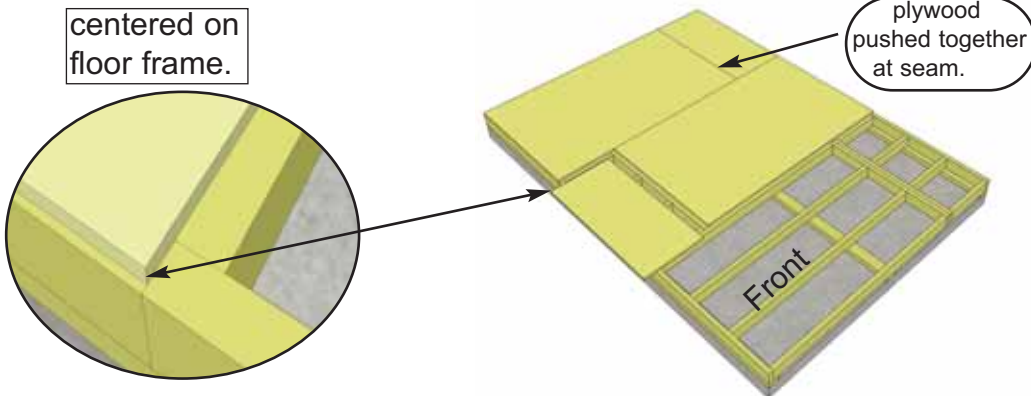
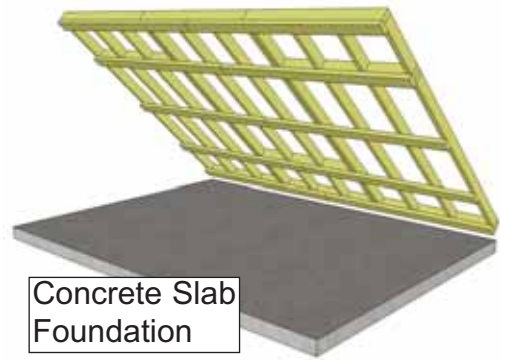

Hint: Use a chalk line to mark location of floor joists to determine screw placement.

9. Position **Plywood Floor** pieces (4) on top of completed floor joists. Plywood will sit slightly back from outside edge of Floor Joist Framing.

10. When in correct position, attach with **1 1/4" screws**. Use screws every 16". The Plywood is cut slightly smaller than floor framing. Keep plywood seams tight.

Hardware (Step 10)
S2 - 1 1/4" Screws
 x 75 total

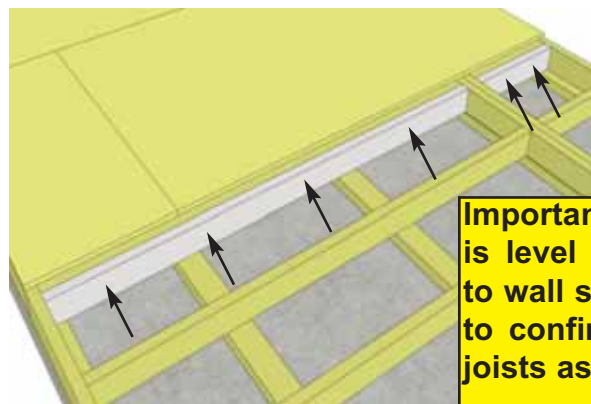
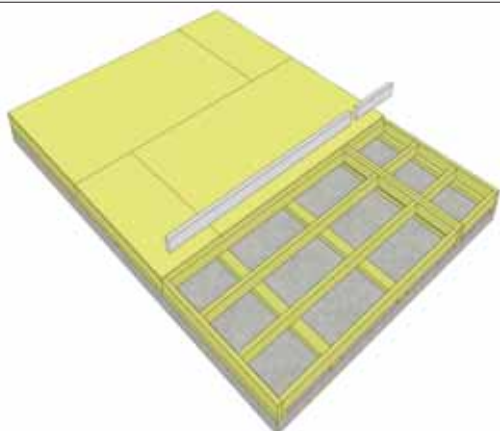
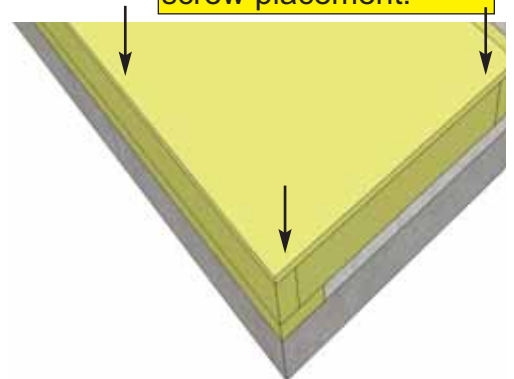

Important: Make sure floor is level before moving on to wall section. Use a level to confirm and shim floor joists as required.

11. Place remaining 71 3/4" **Floor Joist** and 18" **Short Floor Joist** in floor cavity. Attach to floor frame with **4 - 2 1/2" screws** for the long joist and **2 - 2 1/2" screws** for the short joist. These extra joists will make a larger attachment surface for the patio deck boards in **Step 22**.

Hardware (Step 11)
S1 - 2 1/2" Screws x 6 total

Parts (Steps 11)
Short Floor Joist
 (1 1/2" x 3 1/2" 18") x 1
Floor Joist
 (1 1/2" x 3 1/2" x 71 7/8") x 1

B. Wall Section

Exploded view of all parts necessary to complete the Wall Section. Identify all parts prior to starting.

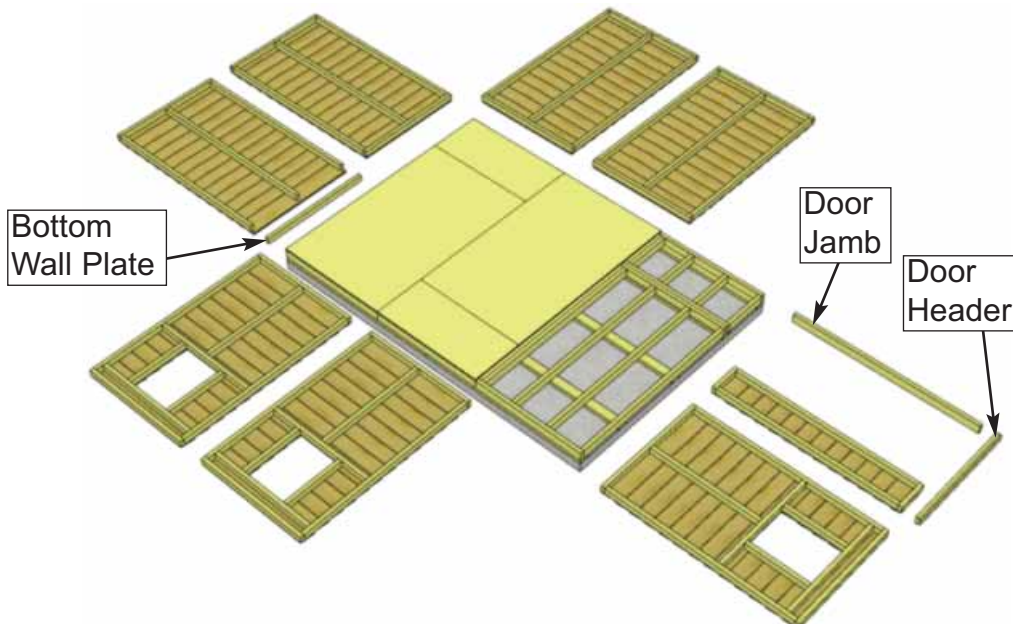
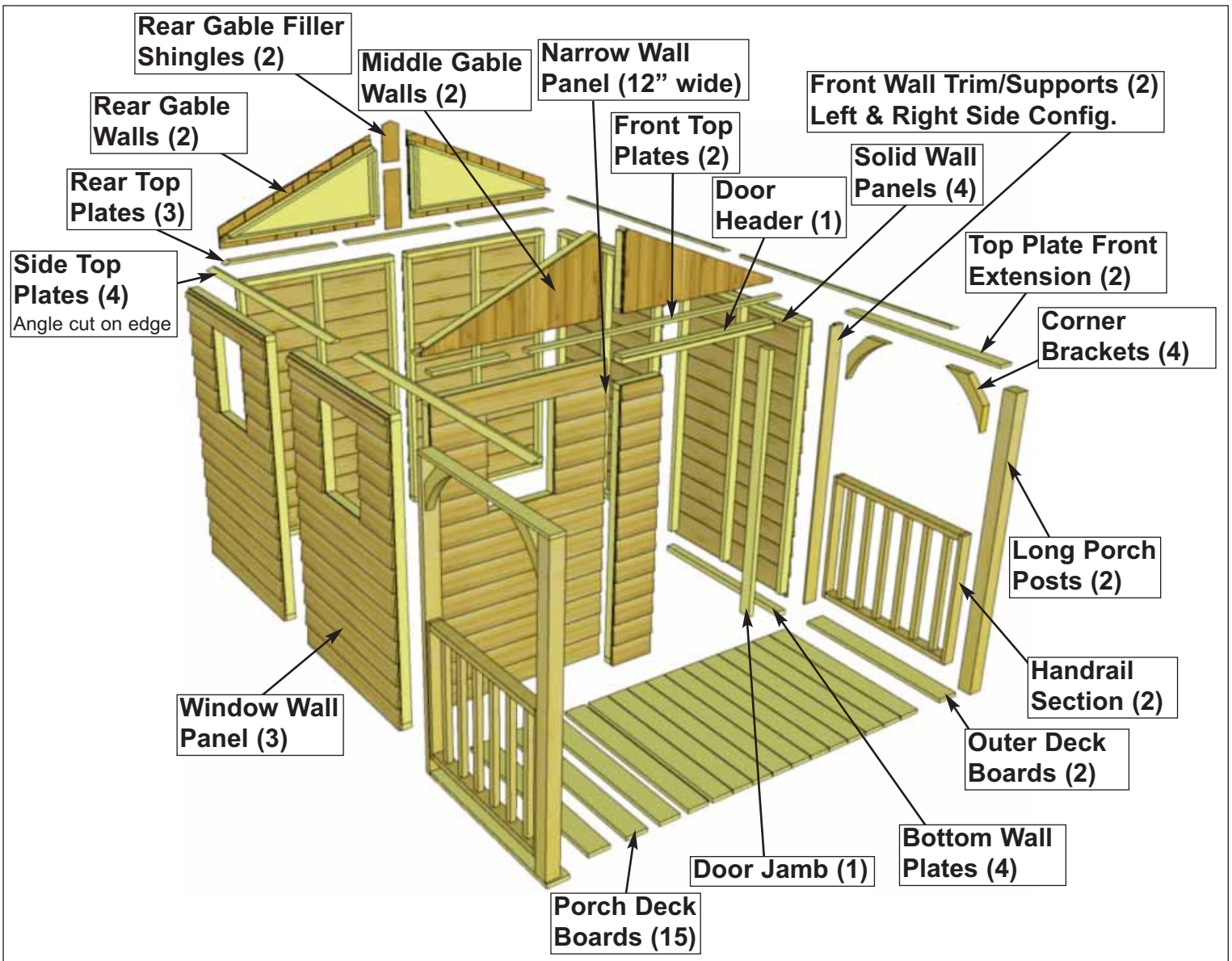

12. Lay out all the wall panels and become familiar with their location. On Standard Kits, there are **3 Window Wall Panels**, **4 Solid Wall Panels**, and **1 Narrow Porch Wall Panel**. Make sure to position panels right side up so water is directed away from and not into shed. Look at window wall panels to determine proper wall orientation.



13. Starting with All **Solid Wall Panels**, carefully lay panel face down. Position and attach **Bottom Wall Plates** to bottom of wall studs of each wall panel with **3 - 2 1/2" screws**. Position so Wall Plates are flush with framing.

Parts (Steps 13)
Bottom Wall Plates
 (1 5/8" x 2 1/2" x 45 1/2") x 4
Solid Wall Panels x 4

Hardware (Steps 13)
S1 - 2 1/2" Screws
 x 12 total

Important: Make sure all walls are aligned in their upright position. If not, water may leak into your playhouse. Unsure if panel is facing up or down? check siding on window wall panel to match alignment.

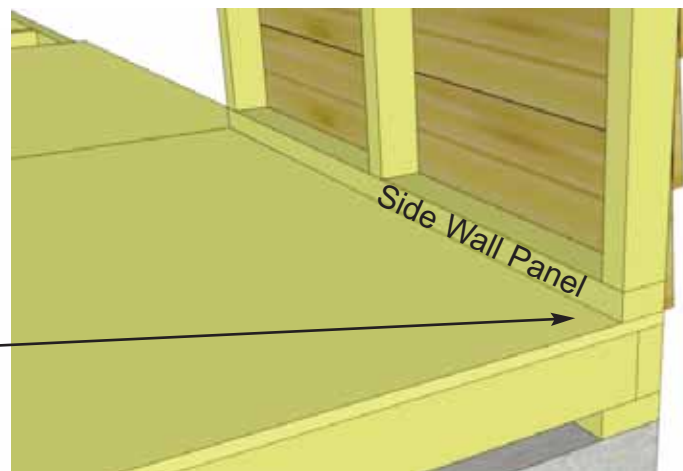

Outside 2x3 Plate of wall panel is flush with outside of floor frame when properly aligned. Floor plywood may be slightly recessed.

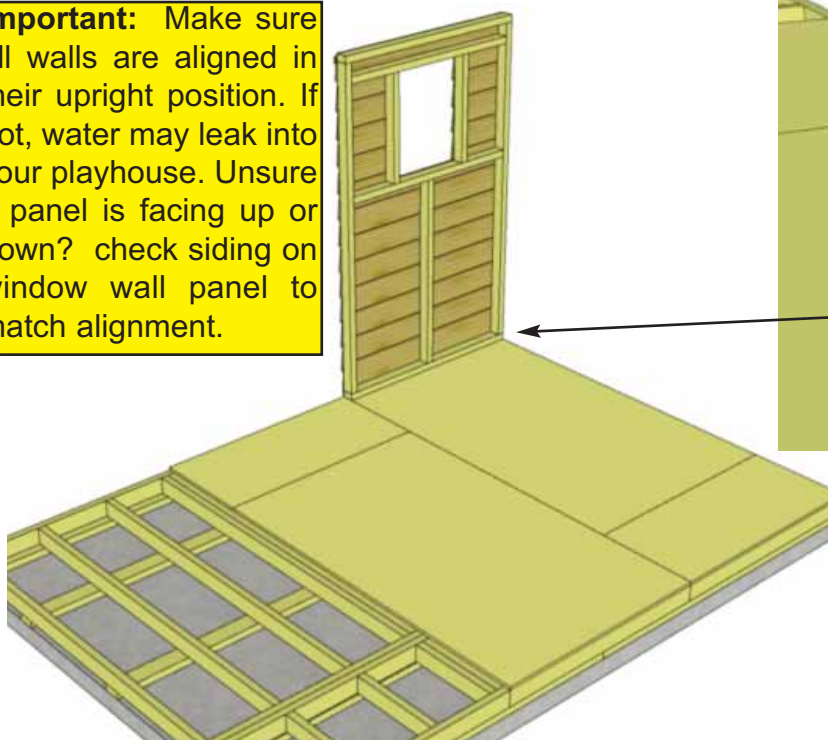

14. Starting at Rear Corner, position a Wall Panel on top of plywood floor. Depending on your preference, you may use a solid or window wall panel in this position. If using a solid wall, make sure panel is facing up. Side Wall panels will sit flush to the end of the plywood floor with the Rear Wall panels sandwiched between them. Position the side wall panel so the wall framing is flush with the floor framing. Floor plywood will be flush or slightly recessed from the wall/floor framing. **Note:** Wall Siding will not be flush with floor frame, it will overhang by approximately 3/4".

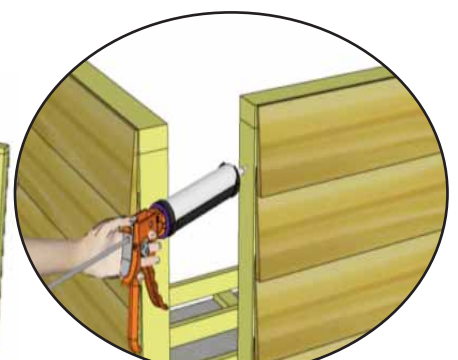

15. Position rear corner wall into place and attach together with **3 - 2 1/2" screws**. Screw at the top, middle and bottom of 2x3 stud. Start positioning adjacent wall panels and fastening together.

Hardware (Steps 15 - 18)

S1 - 2 1/2" Screws
x 21 total

Optional: Caulking seams will help prevent moisture from entering. **Caulking not included in kit.**

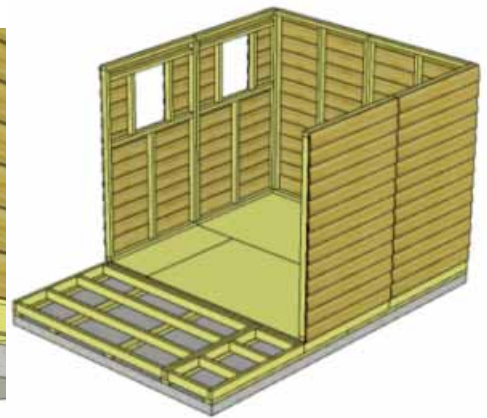
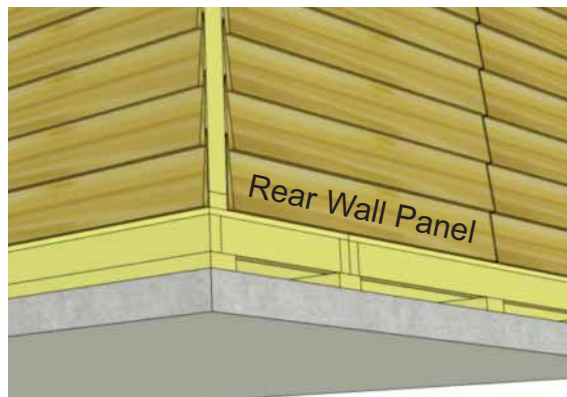

16. Be sure to correctly position wall panels so siding overhangs your floor and wall framing is flush with floor framing. Continue to attach walls together as per **Step 15**.

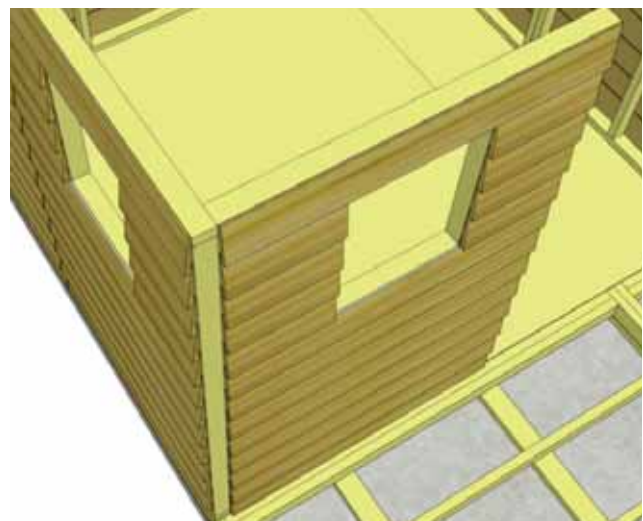
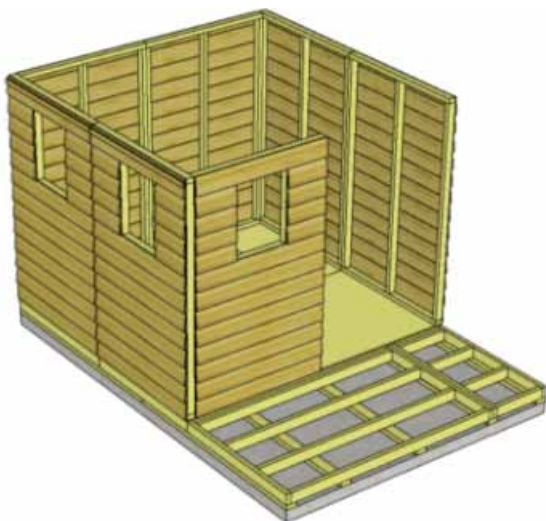

17. When attaching front corner wall panel, make sure panel is nested inside the side panel. Line up wall framing and secure at top, middle and bottom of wall studs.

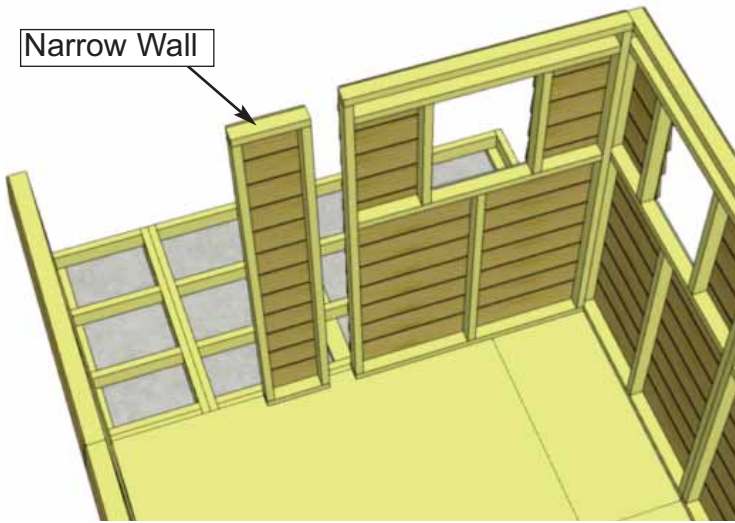

18. To complete walls, attach the **Narrow Porch Wall** to front wall panel. **Note:** the narrow wall is only 73" high. Attach wall stud to adjoining wall with **3 - 2 1/2"** screws.

Parts (Steps 18)
Narrow Porch Wall x 1

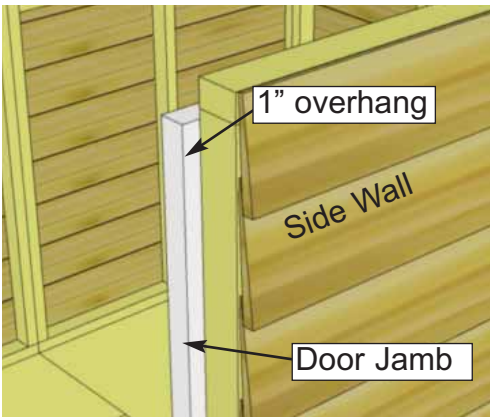

Door Header positioned with Dado to front and top.

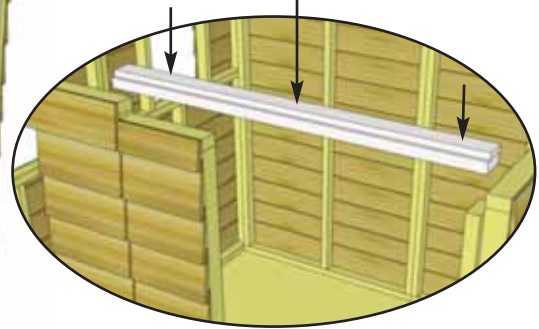

19. Attach **Door Jamb** to right side wall stud. When positioned correctly, the Jamb will overhang the right side wall panel framing by 1/2". When in correct position, secure to wall stud with **4 - 2 1/2"** screws. Align **Door Header** on top of Narrow wall framing and on top of Door Jamb. See picture below. Secure with **4 - 2 1/2"** screws.

Parts (Steps 19)
Door Jamb
 (1 1/2" x 3 1/2" x 73")
 x 1
Door Header
 (2" x 3" x 45 1/2")
 x 1

Hardware (Steps 19)
S1 - 2 1/2" Screws
 x 8 total

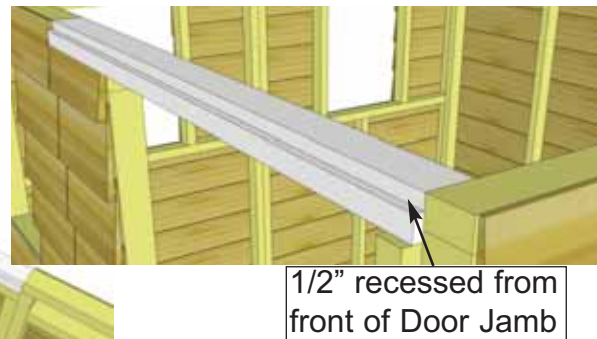
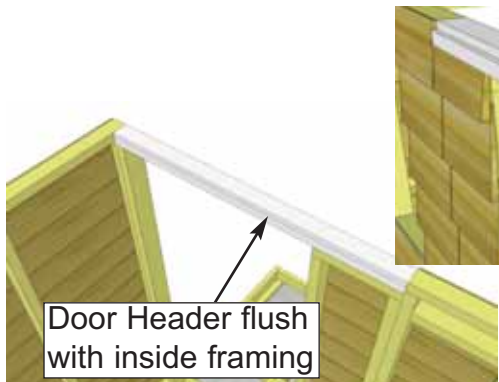

20. Complete the **2 Porch Rail Sections**, following steps **A** through **E**.

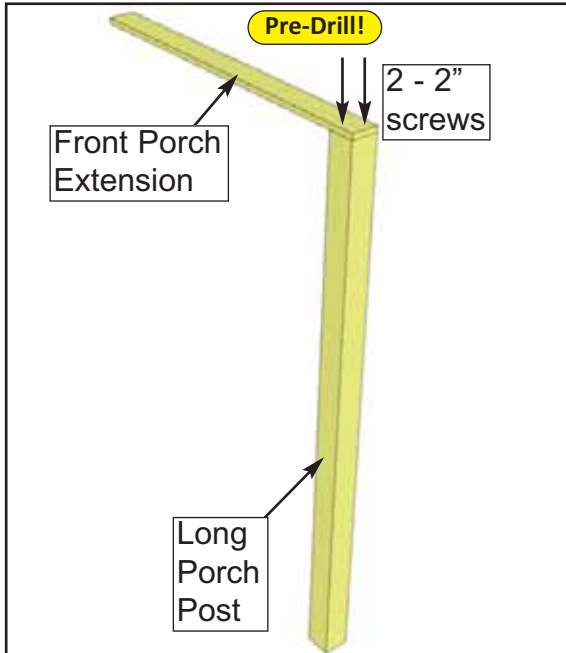

A. Attach **Front Porch Extension** (3/4" x 3 1/2" x 45 1/2") to **Long Porch Post** (3 1/2" x 3 1/2" x 73 7/8") with **2 - 2" screws**. Make sure support is flush with post.

Exploded View of Porch Rail Section

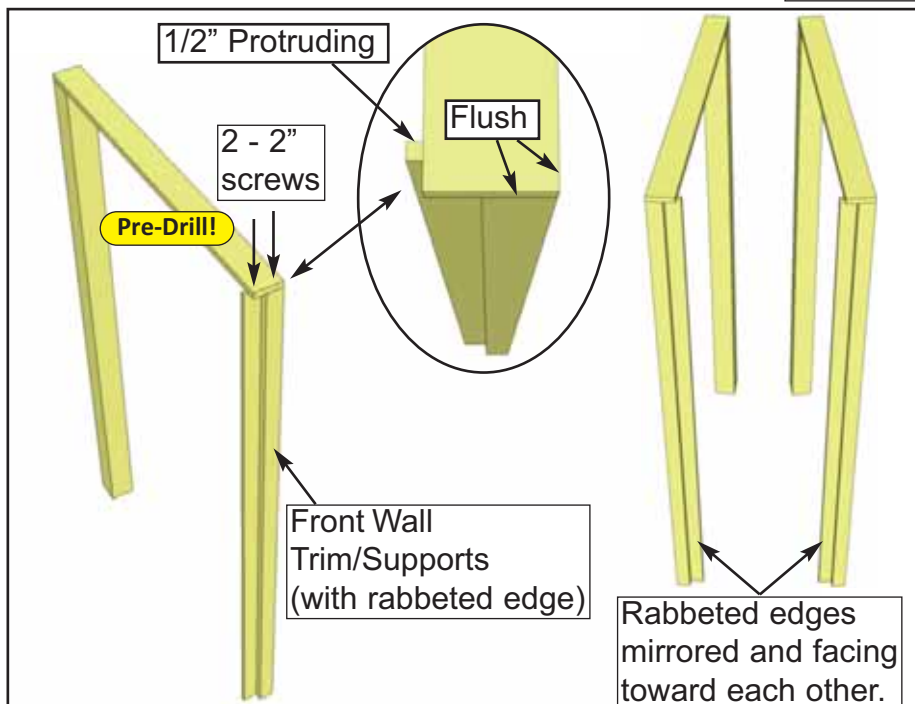
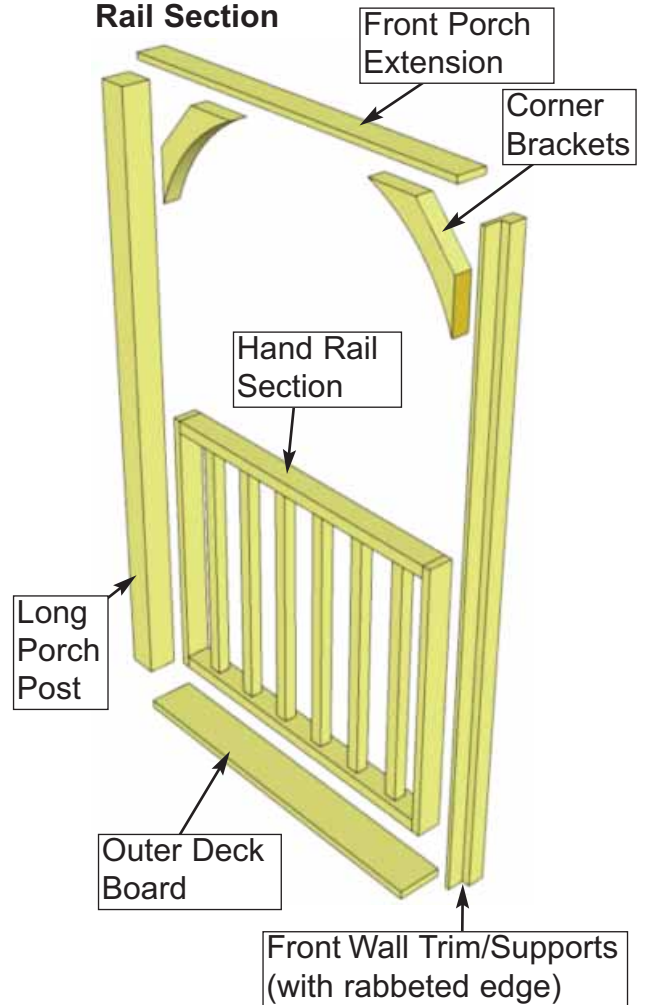

B. Attach **Front Wall Trim/Supports** (1" x 4" x 74 7/8") to Front Extension using **2 - 2" screws**. Make sure Front Extension is Flush to back and thick side of Wall Trim/Supports, and 1/2" protruding on thin side of Wall Trim/Supports

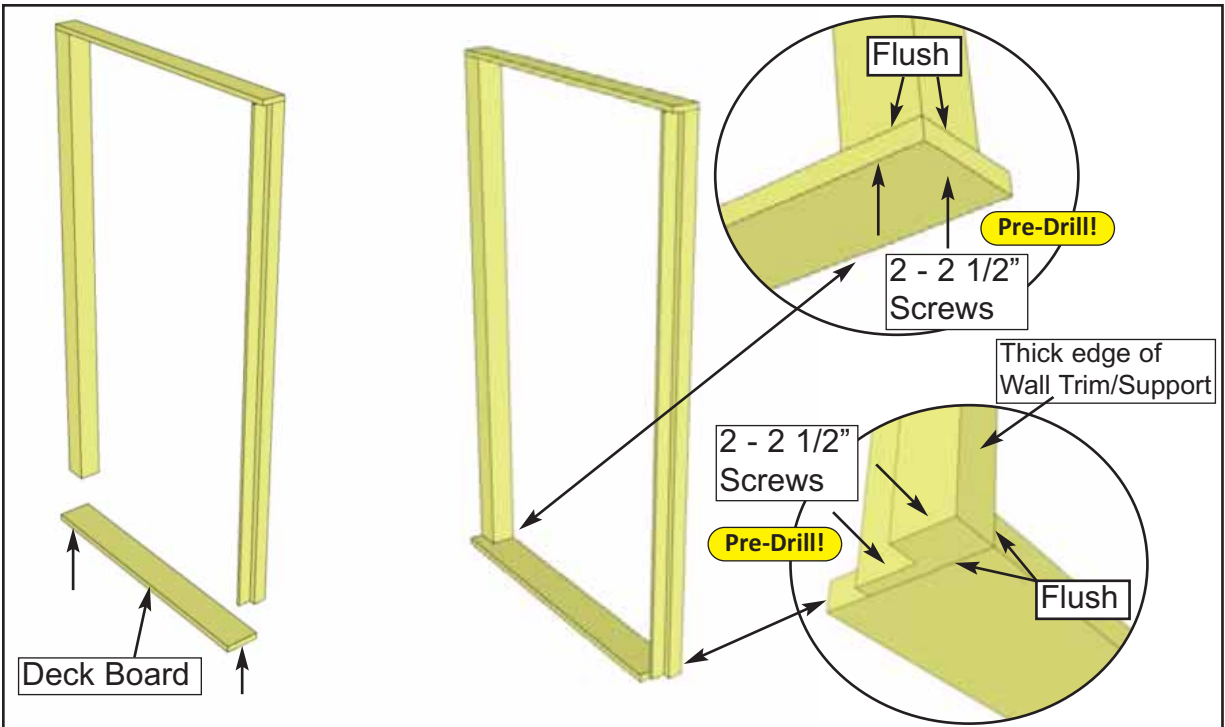

C. Attach **Outer Deck Board** (1" x 5 1/2" x 44") to the Wall Trim/Support with **2 - 2 1/2" Screws** fastened horizontally as shown above. Ensure Deck Board is flush with the thick edge of the Wall Trim/Support. Attach Outer Deck Board to the Long Porch Post with **2 - 2 1/2" Screws** fastened vertically as shown above. Ensure Deck Board is flush with corner of Long Porch Post.

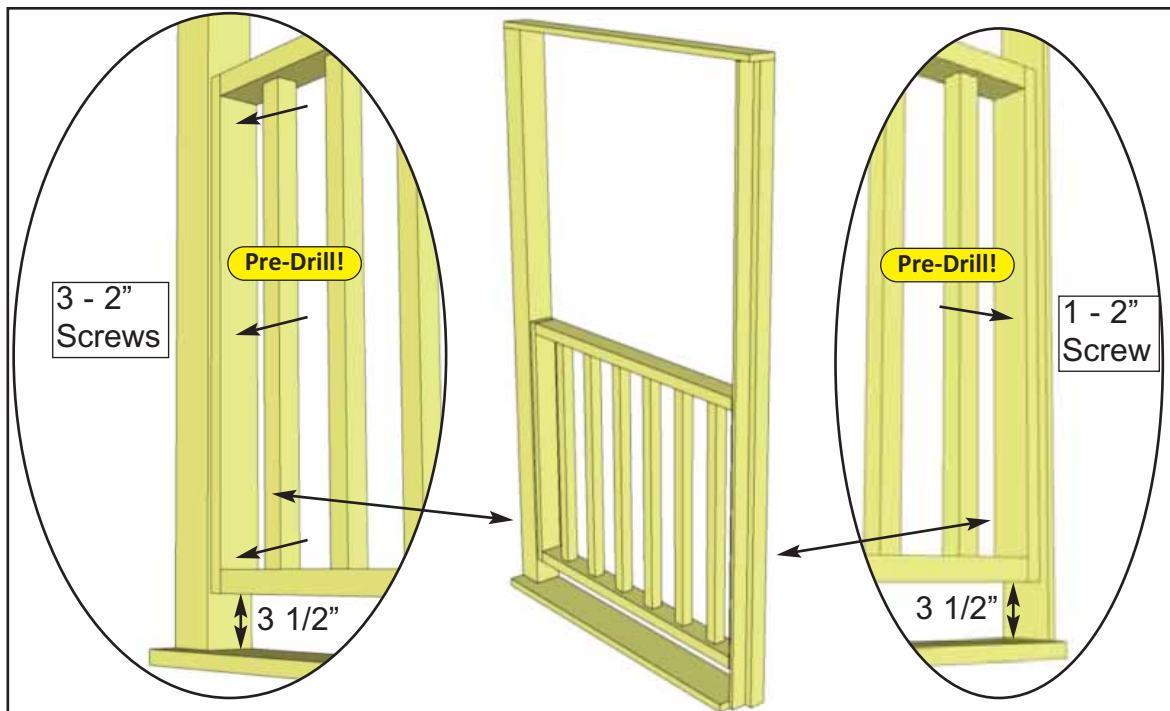

D. Attach a **Hand Rail Section** to the Long Porch Post. Hand Rail should start 3 1/2" from bottom of Post and be centered side-to-side. Use **3 - 2" Screws** to attach. Attach Hand Rail to Wall Trim/Support with **1 - 2" Screw** for now, more screws will be added when it is attached to the wall in **Step 28**.

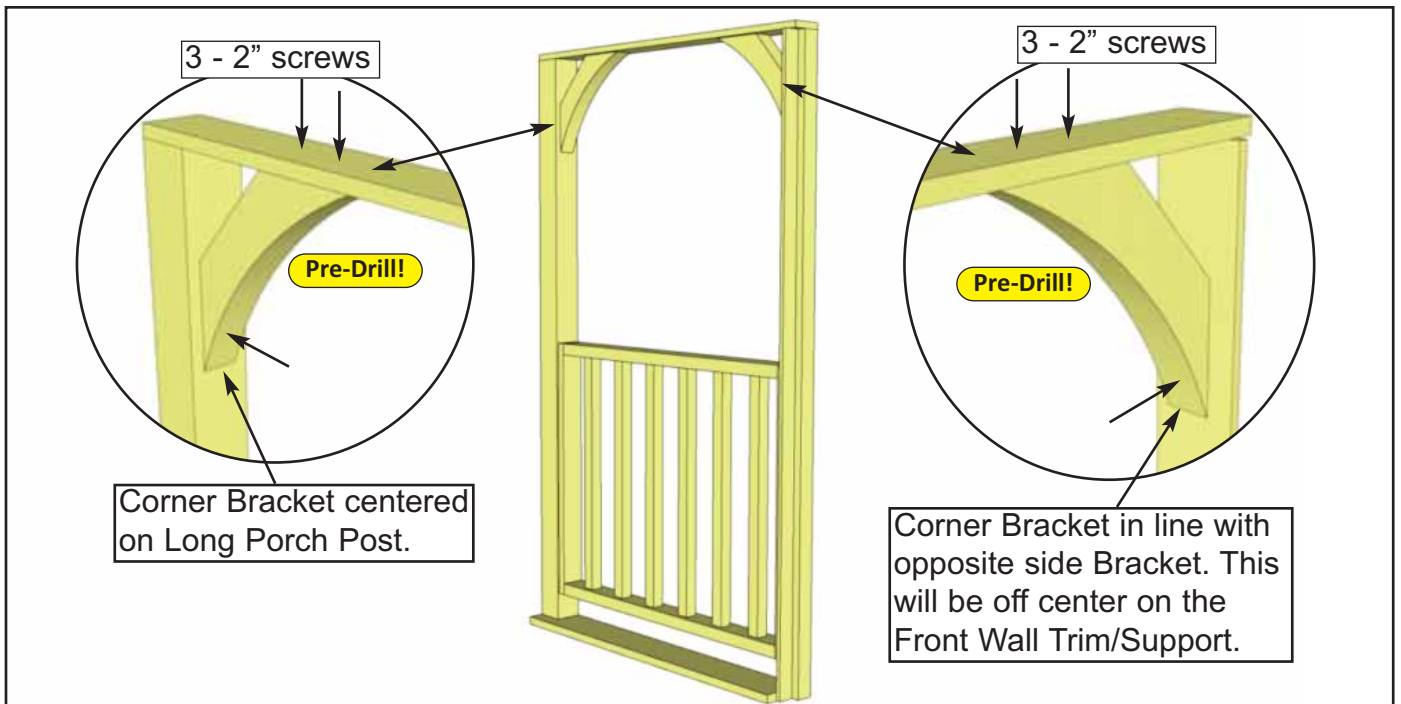

E. Position **Corner Bracket** centered on the Long Porch Post as shown. Position opposite side Corner Bracket in line with first. Attach each Corner Bracket with **3 - 2" Screws**. Fasten two screws down through Front Porch Extensions into Bracket, and the third screw horizontally through the bottom of the Corner Bracket. Drill Pilot holes before screwing to prevent splitting.

Completed view of both Porch Rail Sections

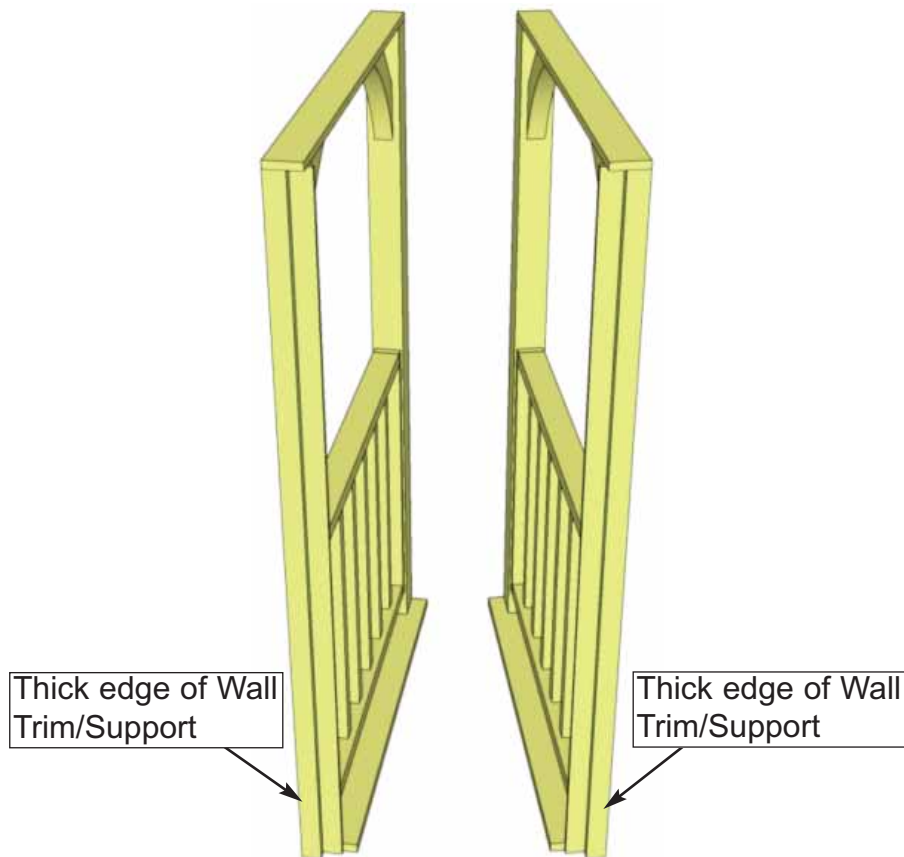

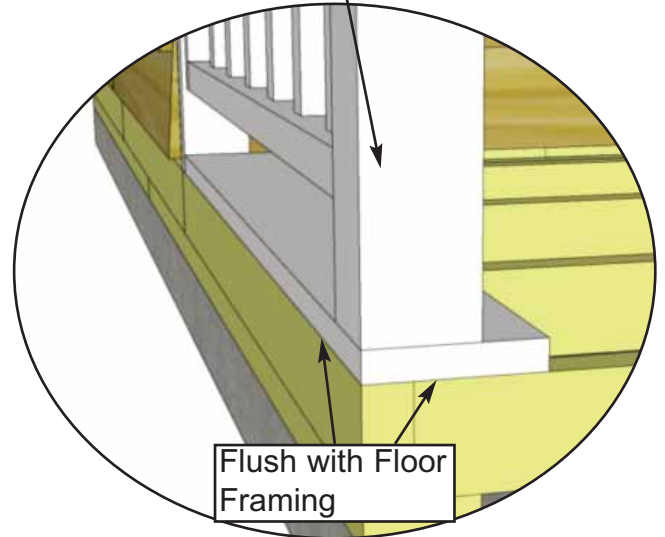
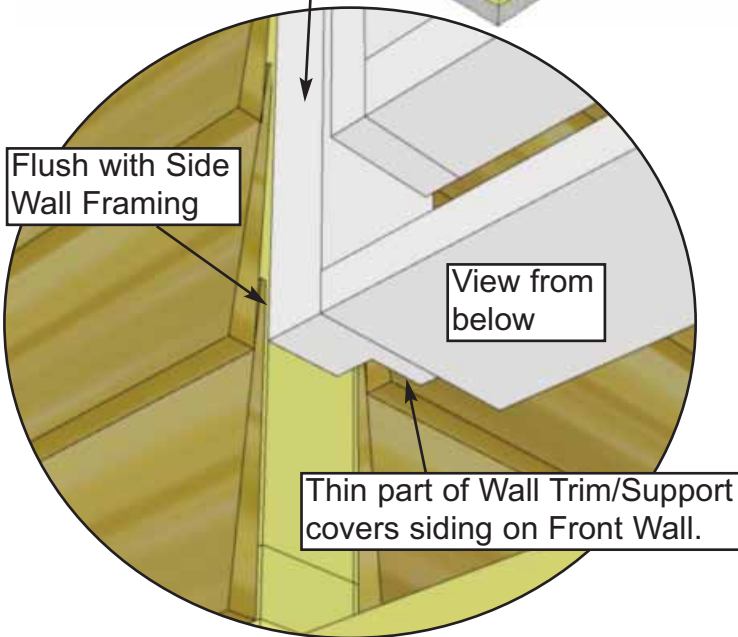
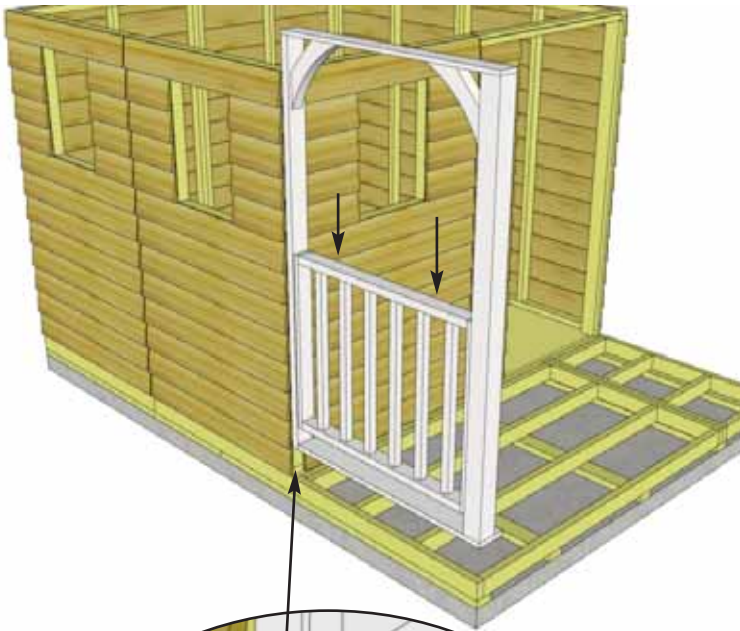

21. With the Porch Rail Sections complete, attach to the deck area as shown. Outer Deck Board will be positioned flush with the Floor Frame in the front corner. Fasten to Floor Joists with **4 - 2" Screws**. Pre-drill pilot holes before fastening screws. Complete other side the same.

Hardware (Steps 21)

S3 - 2" Screws

x 8 total



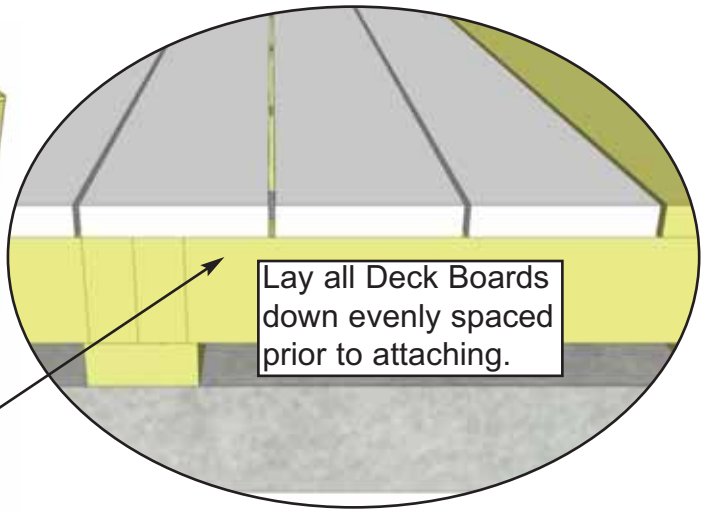

22. Attach remaining 15 **Deck Boards** using **4 - 2" Screws** per piece. Equally space all deck boards before attaching. Ensure screws enter the floor joists beneath deck boards. Pre-drill for screws at the ends of the deck boards.

Parts (Steps 22)

Deck Boards

(1" x 5 1/2" x 44 1/2") x 15

Hardware (Steps 22)

S3 - 2" Screws

x 60 total

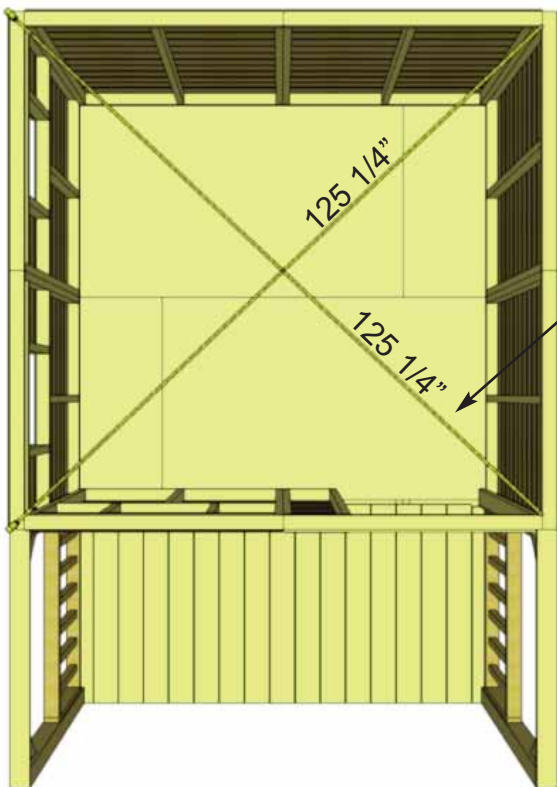
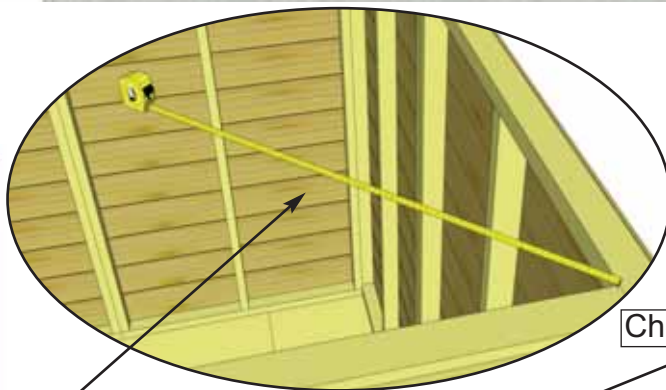
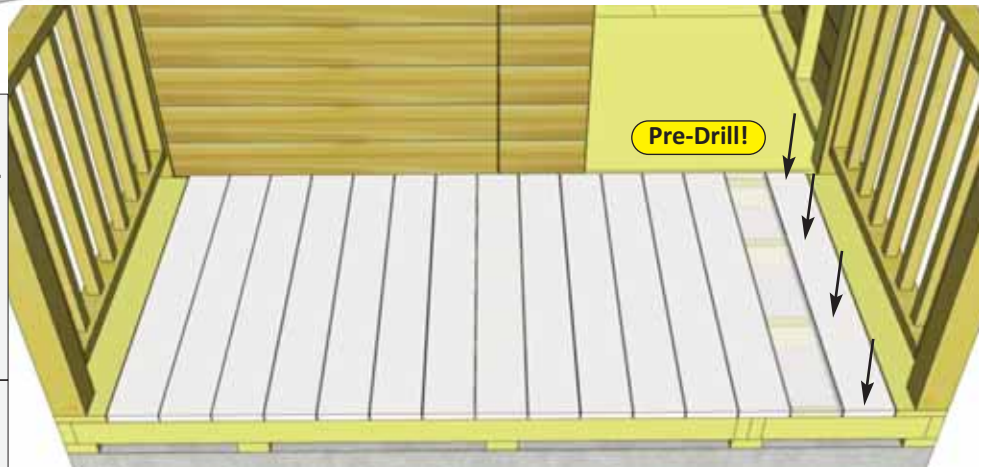

Check for plumb



23. Prior to fastening walls and installing rafters, take time to confirm your walls are level, square and plumb. Measure diagonal at top and bottom of walls corner-to-corner. This should be approximately 125 1/4", but more importantly if measurements are not within 1/4", your walls are not square. Adjusting now will make it easier to install roof section.

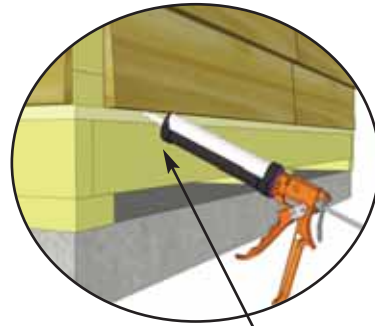
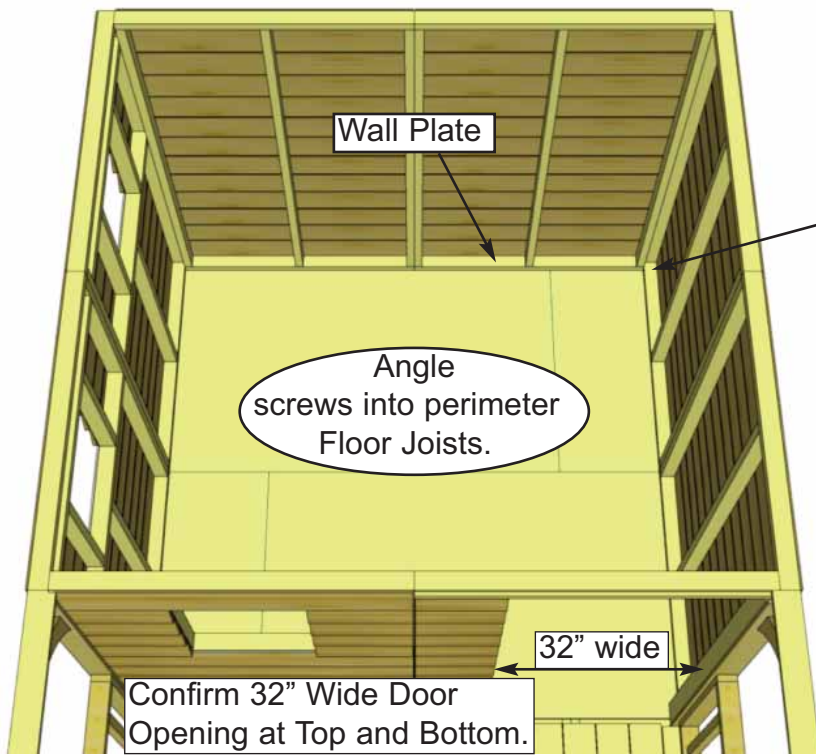

Optional - Caulking seams will help prevent moisture from entering your shed.
Caulking not included in kit.

24. When all walls are attached together, check alignment with the floor. Bottom wall plates should sit flush with outside of floor frame. When positioned correctly, fasten bottom wall plates to floor using **4 - 2 1/2" screws** per wall panel.

Hardware (Steps 24)
S1 - 2 1/2" Screws
 x 32 total

25. Position **Rear Top Plates** on top of wall studs so they are flush on the inside with 2x3 wall stud. The Top Plate is comprised of 3 pieces (2 outside pieces with an angle cut on one end and a center piece that is straight cut). Attach by screwing down into top wall plate with **2 - 2" screws** per plate.

Parts (Steps 25)
Rear Top Plates
 (3/4" x 2 1/2" x 32") x 3

Hardware (Steps 25)
S3 - 2" Screws
 x 6 total

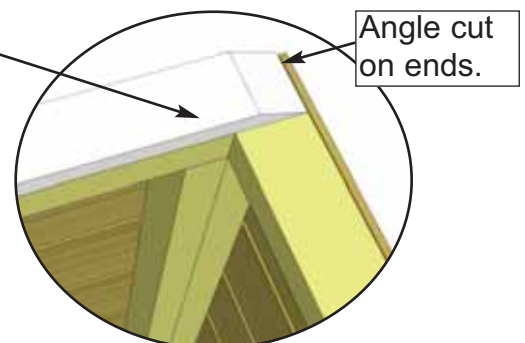
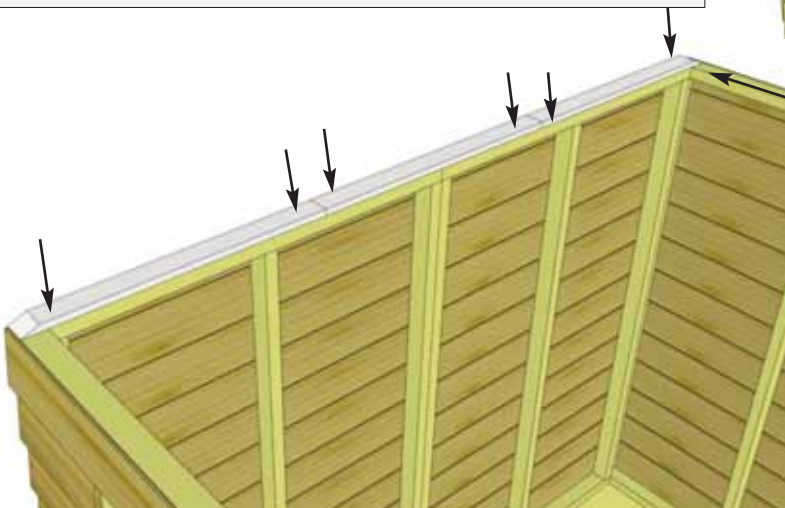
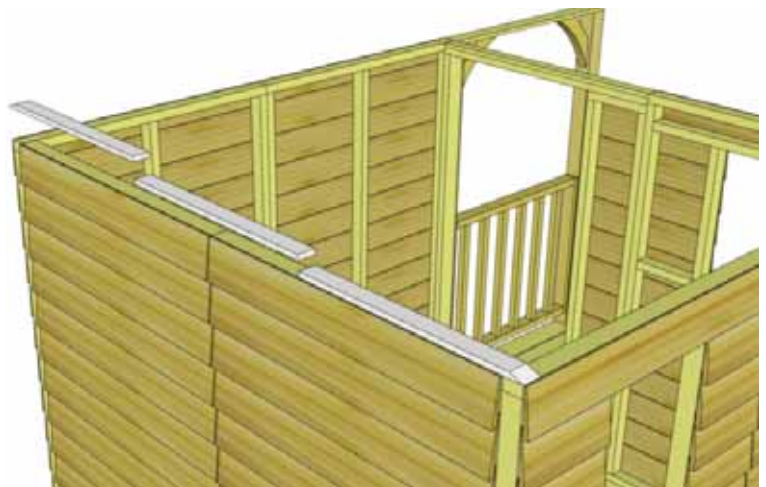

Top Plates should be flush with inside of wall framing.

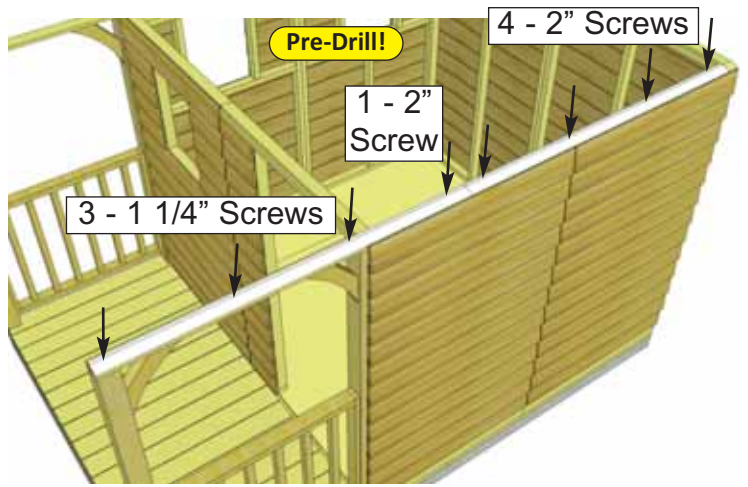
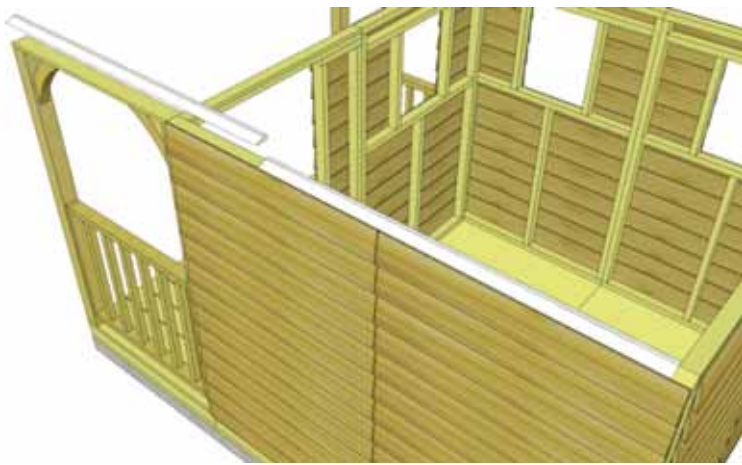

26. Attach the 4 **Side Top Plates**. The side top plates are angle cut down the length. Once again, position top plate on wall plate so it is flush with inside of wall plate. Side plate should also be flush with rear wall plate. Secure with:
4 - 2" screws per rear piece.
1 - 2" screw & 3 - 1 1/4" screws per front piece.

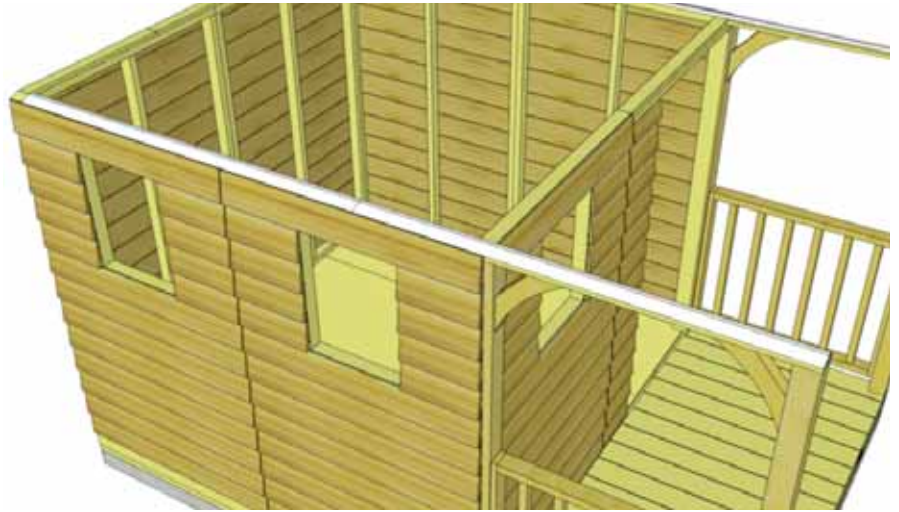

Parts (Steps 26)	
Side Top Plates	
(3/4" x 2 1/2" x 67") x 4	
Hardware (Steps 26)	Hardware (Steps 26)
S3 - 2" Screws x 10 total	S2 - 1 1/4" Screws x 6 total

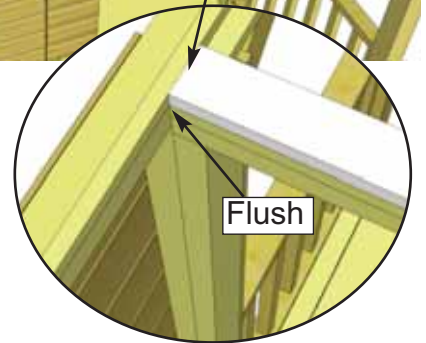
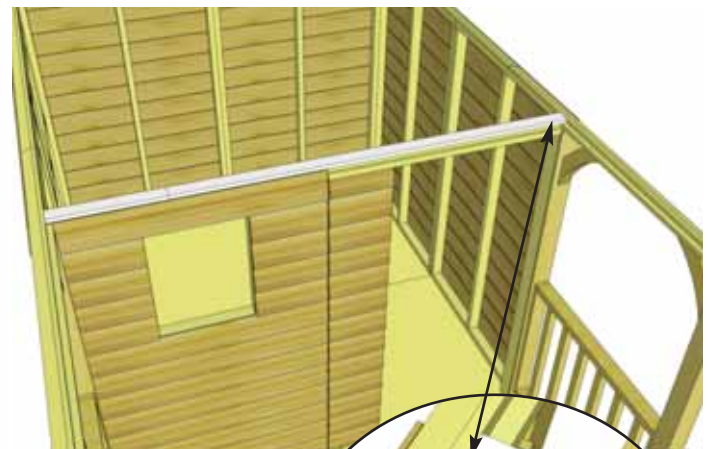

27. Position the **Front Top Plates** on top of Door Header and front wall panel. There are 2 plates (72" and 19" long). Front top plates are straight cut on the ends. Once again, the plate will be flush with inside of top wall framing. Attach with **6 - 2" screws** (4 screws in long and 2 in short plate).

Parts (Steps 27)	
Front Top Plates	
(3/4" x 2 1/2" x 72" & 19") x 2	
Hardware (Steps 27)	
S3 - 2" Screws x 6 total	

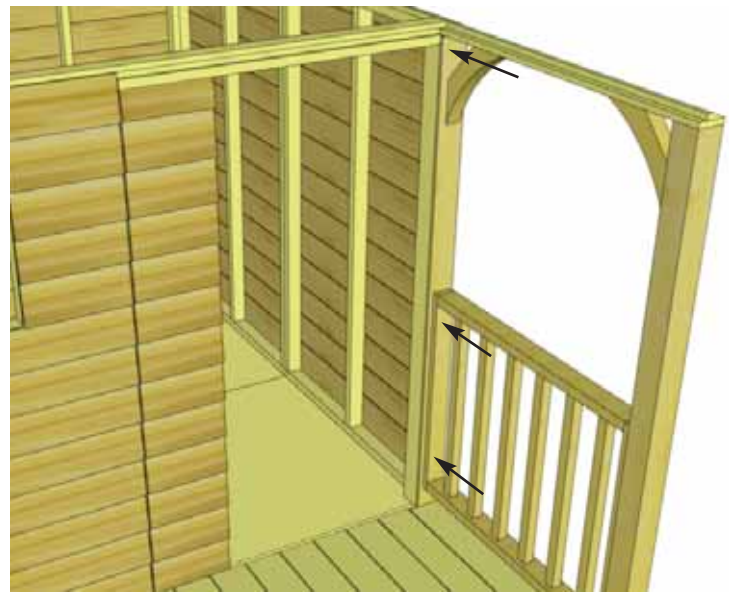

28. Attach **Wall Trim/Supports** to wall with **3 - 2 1/2" screws** per side. Try to conceal screws if possible.

Hardware (Steps 28)

S1 - 2 1/2" Screws

x 6 total

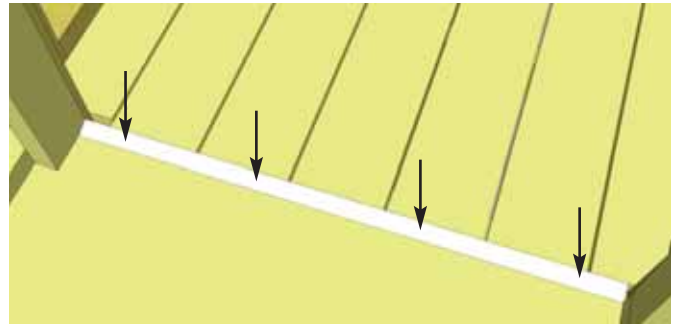
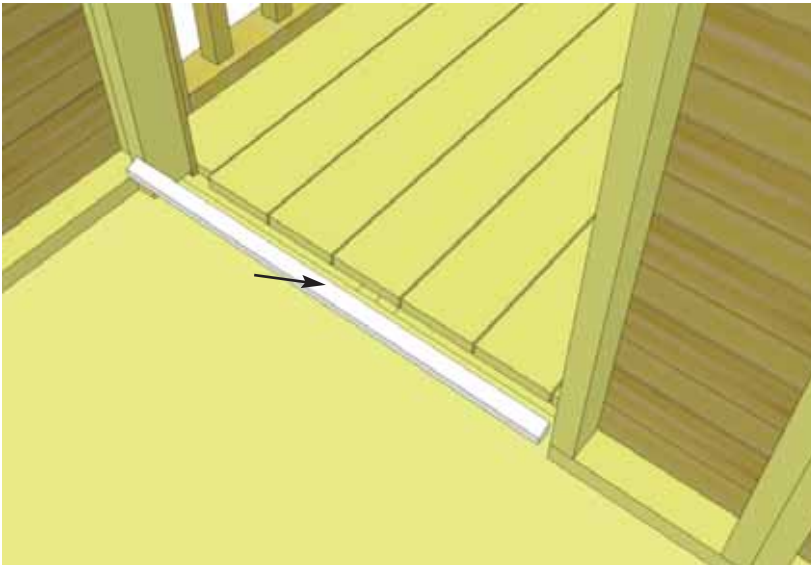

29. At the doorway of your shed there will be a small gap between the deck boards and floor plywood. Fill this gap with the **Doorway Floor Transition Strip** - angle edge cut and attach with **4 - 1 1/2" Finishing Nails**.

Parts (Steps 29)

Doorway Floor Transition Strip

(1" x 1" x 32") x 1

Hardware (Steps 29)

N1 - 1 1/2" Finishing Nails

x 4 total

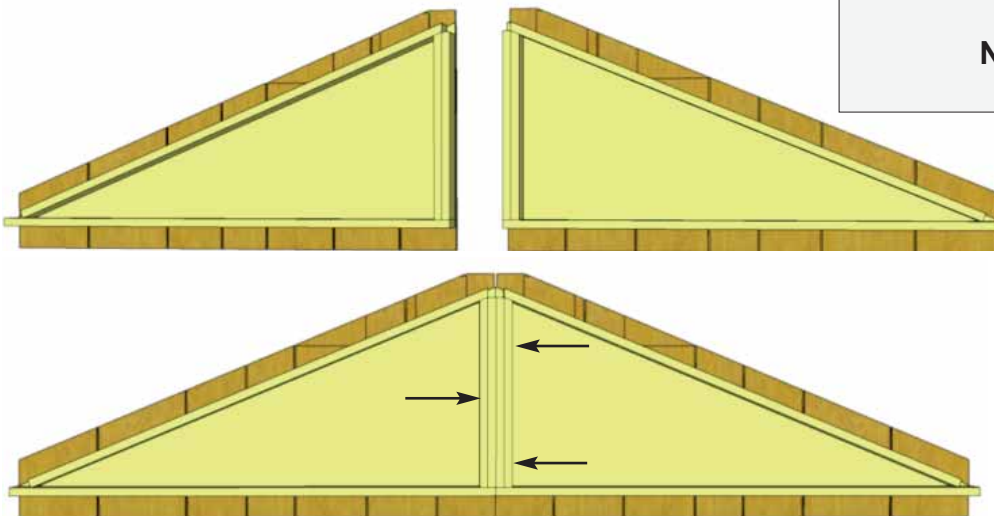

30. Locate both Rear Gable Wall pieces. Rear Gables have shingles that overhang the top and bottom of the gable frame. Screw together with **3 - 2 1/2" screws**.

Parts (Steps 30)

Rear Gable Walls x2

Hardware (Steps 30)

S1 - 2 1/2" Screws

x 3 total

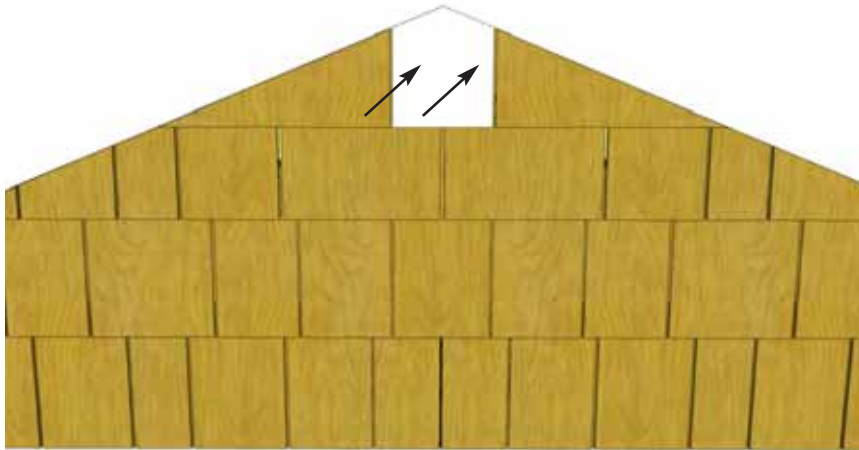
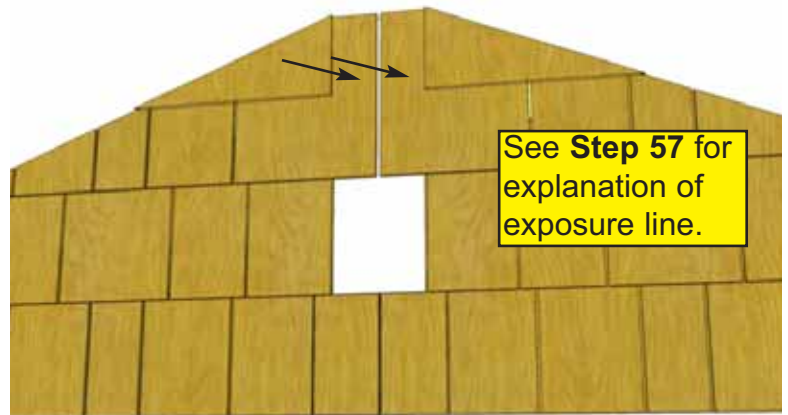
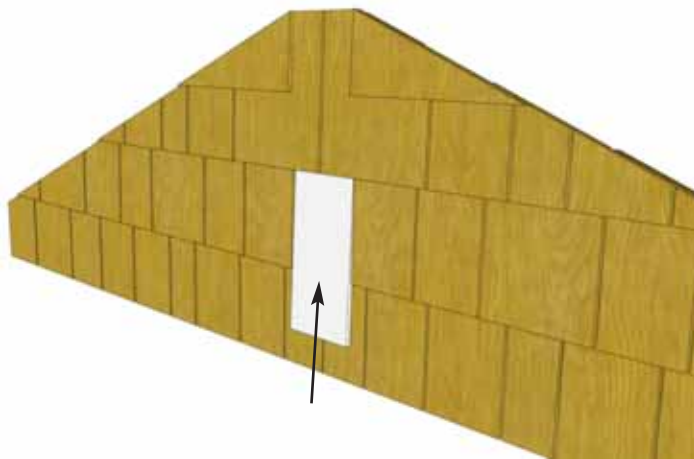

31. From the outside, slide in a Rear Gable Wall Filler Shingle to cover gable seam. Nail down above the exposure line with **2 - 1 1/2" Shingle Nails**.

Complete by attaching the short 7 1/2" top Filler Shingle with **2 - 1 1/2" Shingle Nails**.

Parts (Steps 31)

Rear Gable Filler Shingles x2

Hardware (Steps 31)

N2 - 1 1/2" Shingle Nail

x 4 total



32. Position the **Rear Gable Wall** on top of the Rear Top Plate. The rear gable framing should sit flush with the inside of the top plate. It should also be centered sideways on the top plate. **Hint:** use a straight edge to check the angle of the gable framing and top plate. Both angles should line up. Adjust gable accordingly. Temporarily attach to walls and Top Plate with **2 - 2" screws**. Gables may need slight adjustment in **Step 46**. Complete attachment in **Step 50** with additional **8 - 2" screws**. Screw from the bottom of gable framing down into Top Plate and Wall.

Hardware (Steps 32)

S3 - 2" Screws

x 2 total

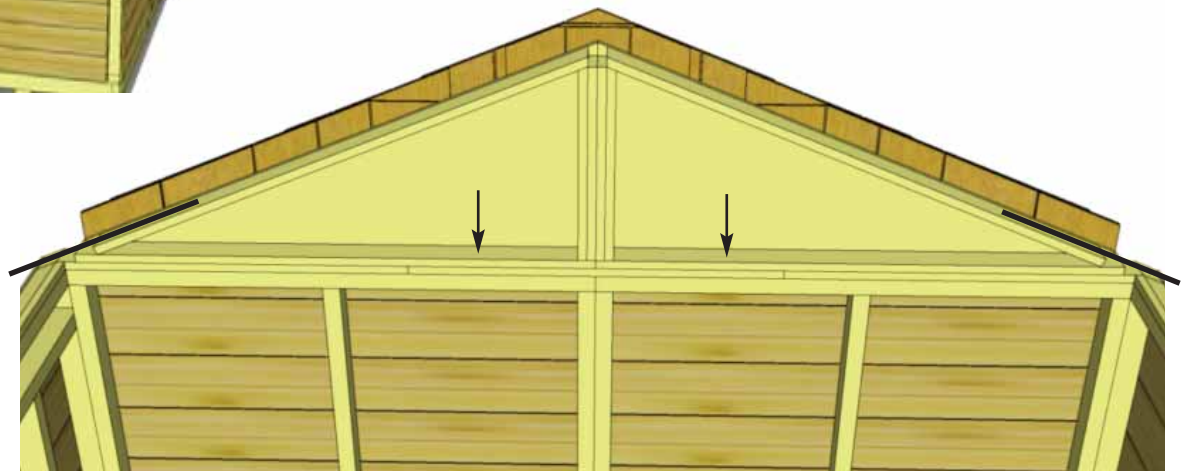

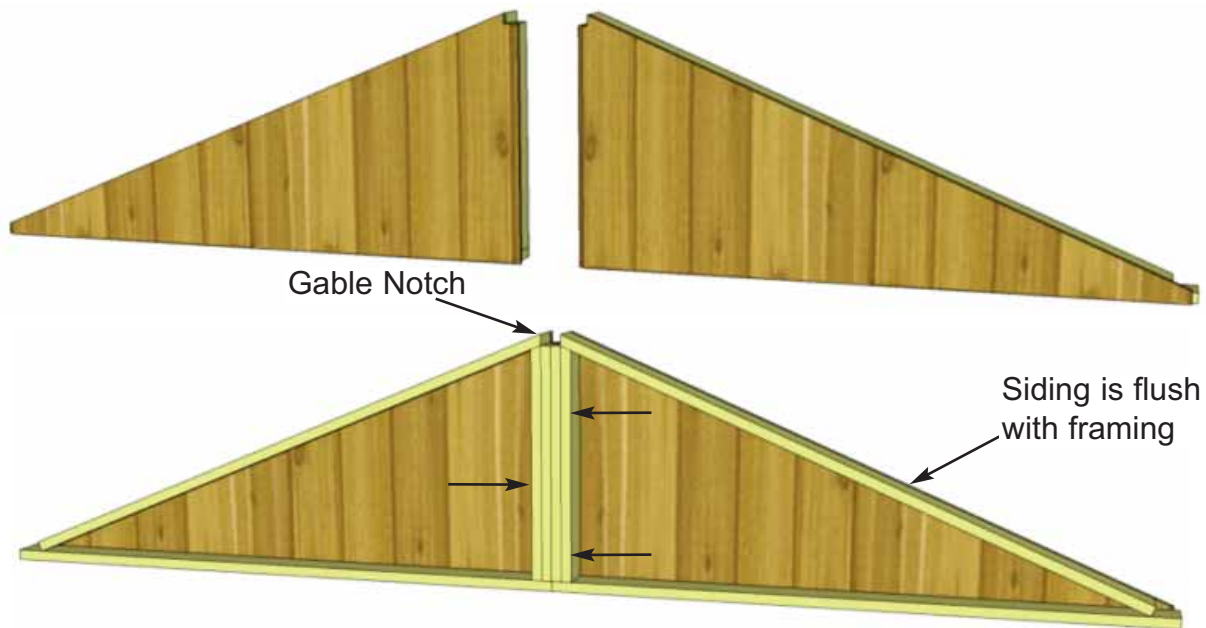

33. Locate both Middle Gable Walls and attach together as per **Step 30**.

Parts (Steps 33)
Middle Gable Walls x2

Hardware (Steps 33)
S1 - 2 1/2" Screws
 x 3 total

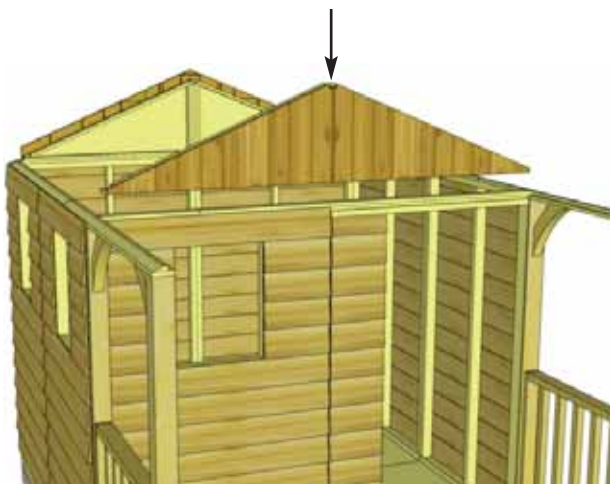

34. Position the **Middle Gable Wall** on top of front top plate. Middle gable has cedar siding on the front that is cut flush with gable framing. Once again, the framing of the gable should be flush with outside of plate and be centered sideways on the plate. When in correct position, attach with **2 - 2" screws** temporarily as per **Step 30**.

Later in **Step 46**, complete attachment with 8 more 2" Screws.

Hardware (Steps 34)
S3 - 2" Screws
 x 2 total



C. Rafter and Roof Section

Exploded view of all parts necessary to complete the Roof Section.
Identify all parts prior to starting.

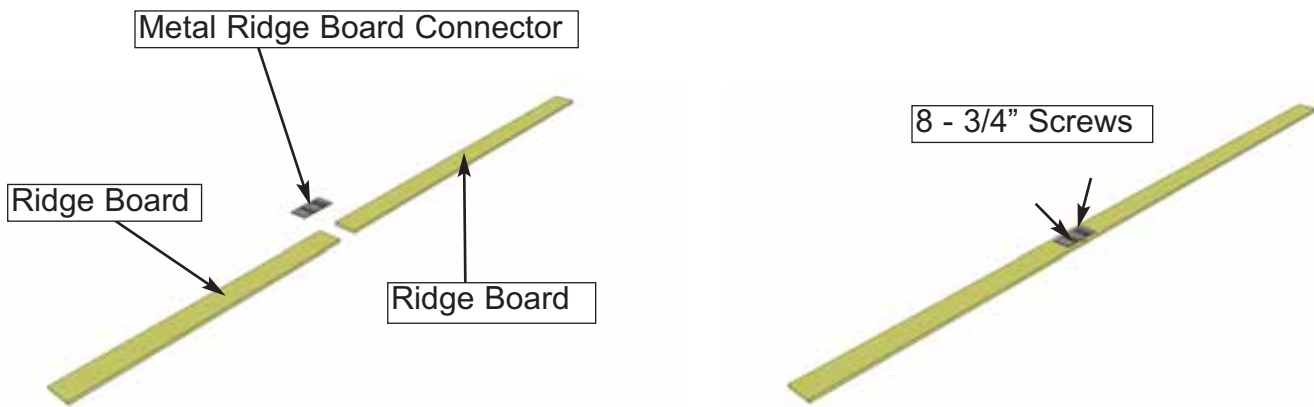
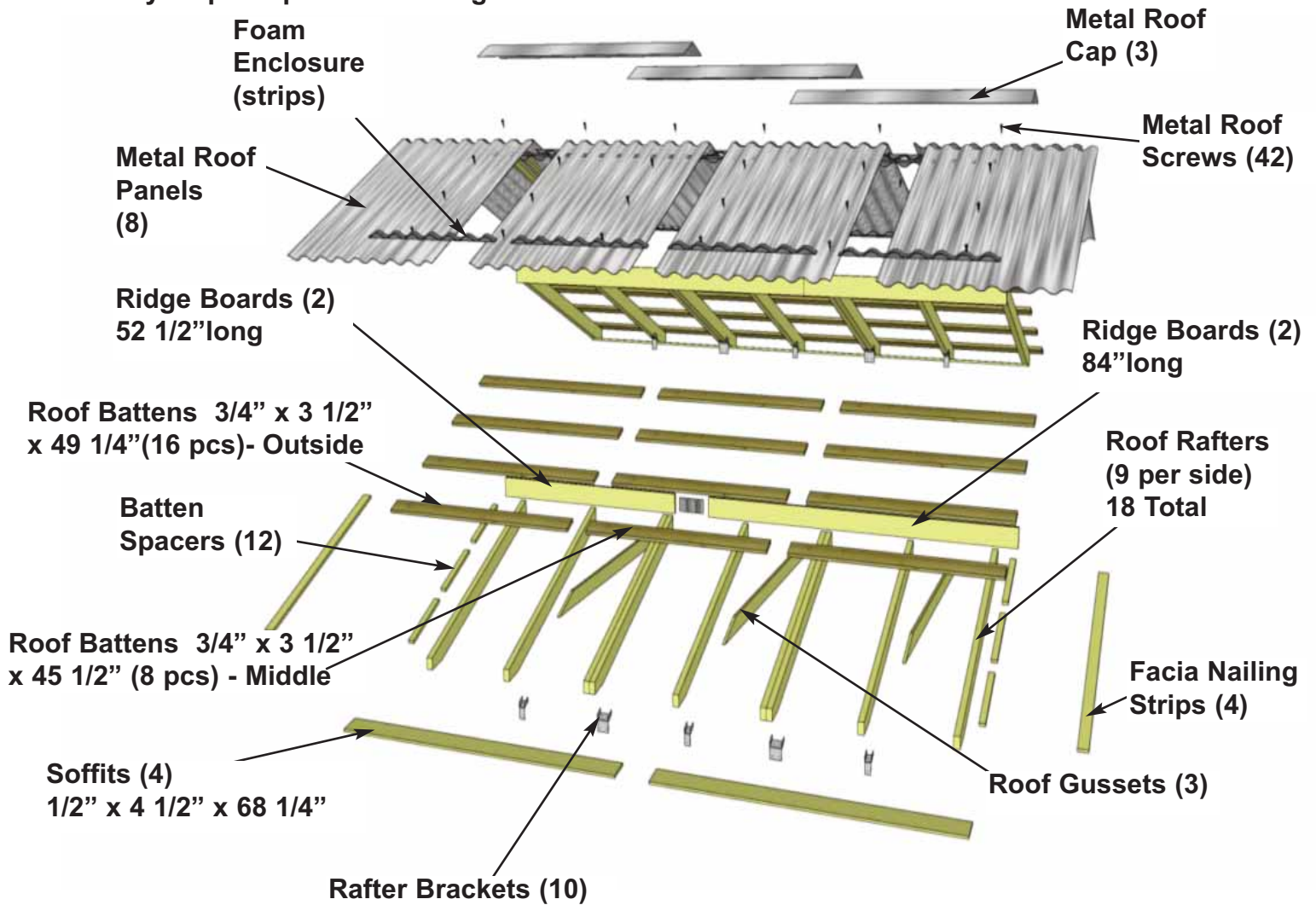

35. Locate **Ridge Boards Long & Ridge Boards Short** and attach together with **Metal Ridge Board Connector** using **8 - 3/4" silver screws**. Position **Metal Ridge Board Connector** evenly on **Ridge Boards**. Total length when connected is 136 1/2". Complete two sets.

Parts (Step 35)
Ridge Board Long
 (3/4" x 4 1/2" x 84") x 2
Ridge Board Short
 (3/4" x 4 1/2" x 52 1/2")
 x 2

Hardware (Step 35)
SS2 - 3/4" Screws
 x 16 total

36. Locate **9 - Rafters**, **2 - Soffits** & completed **Ridge Board**. Lay out on level ground as shown to the right. Double up **Rafters** as illustrated. Screw doubled up **Rafters** together with **3 - 2 1/2" screws** per piece. **Note:** completed Rafter section will be flipped over in **Step 38**.

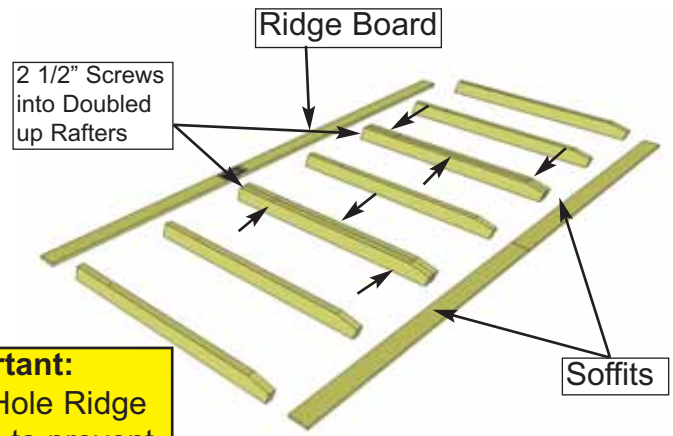

Parts (Steps 36 - 38)

Rafters

(1 1/2" x 3 1/2" x 56 1/2") x 18

Soffits

(1/2" x 4 1/2" x 68 1/4") x 4

Hardware (Steps 36 - 38)

S1 - 2 1/2" Screws

x 16 total

S2 - 1 1/4" Screws

x 16 total

S3 - 2" Screws

x 16 total

Important:
Pilot Hole Ridge Board to prevent splitting!

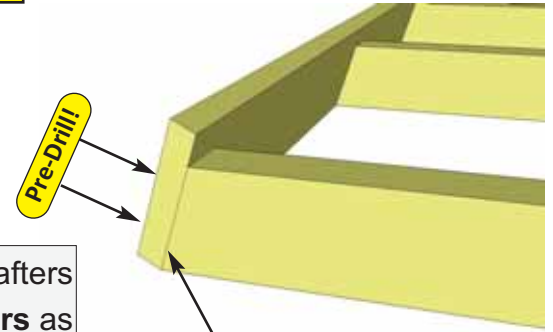

37. Attach completed **Ridge Board** to ends of both outside rafters with **2 - 2" screws** per end. Measure and position interior **Rafters** as illustrated below. When positioned correctly, attach **Ridge Board** to remaining rafters with **2 - 2" screws** per **Rafter** end.

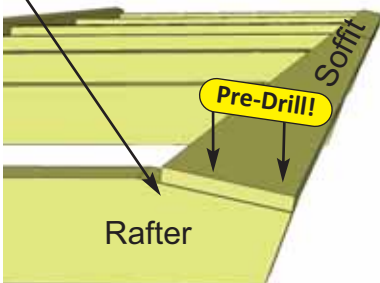
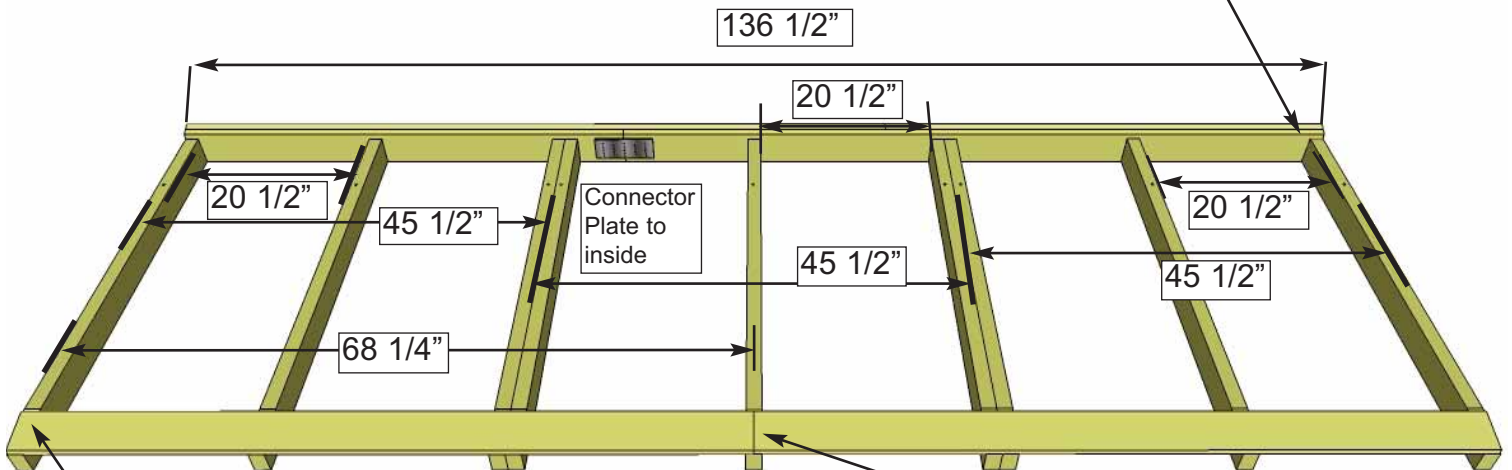

Important:
Pilot Hole Soffit to prevent splitting!

Carefully flip Rafter Sections over when complete

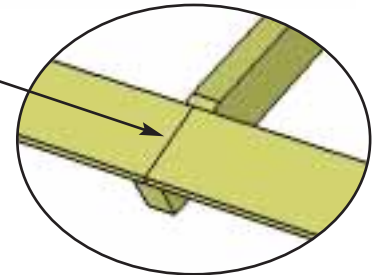

38. Attach end of a **Soffit Board** flush to ends of outside **Rafters** with **2 - 1 1/4" screws** per rafter end. Drill pilot hole in **Soffit** ends to prevent splitting. Complete both outside **Rafter & Soffit** connections first. Measure and position interior **Rafters** as illustrated above. When positioned correctly, attach **Soffits** to remaining **Rafters** with **2 - 1 1/4" screws** per **Rafter**. Flip completed **Rafter** section over. Complete 2nd **Rafter** section now as per **Steps 35 - 38** with the following exception. **When attaching Ridge Board to Rafter ends, make sure Ridge Board Connector is positioned offset to first Rafter Section. See Step 45 for illustration.**

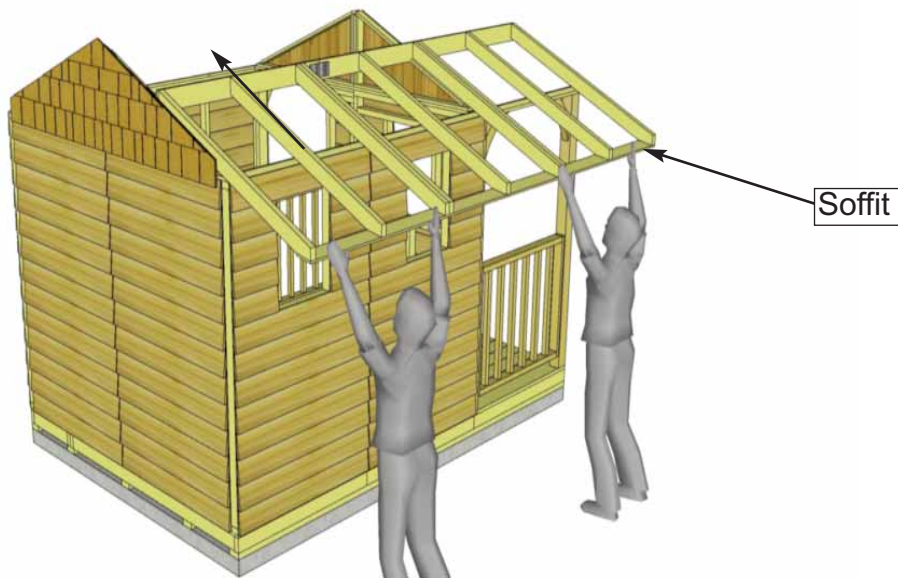

39. Carefully lift 1 completed **Rafter** Section up (make sure **Soffit** is facing down) and place on gable framing.

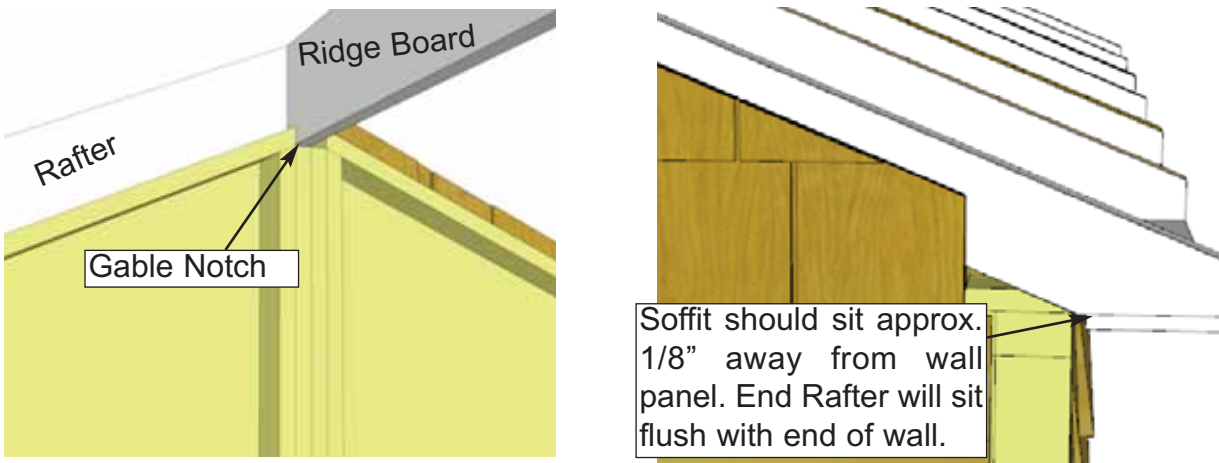

40. Slide **Rafter** Section up on gable framing until bottom of **Ridge Board** slips into gable notch. **Soffit** will sit approximately 1/8" away from wall panel.

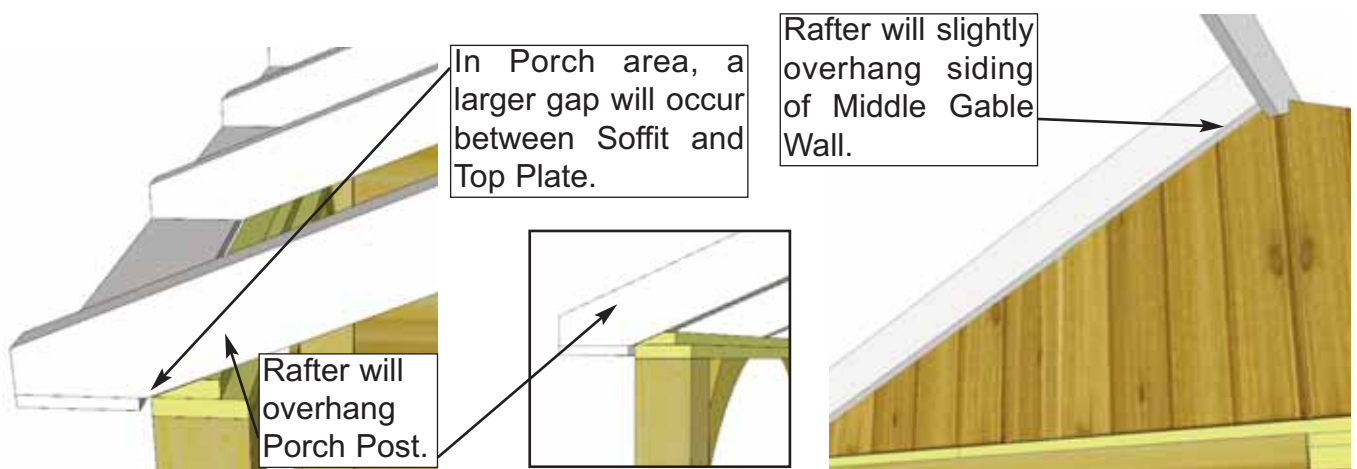

41. To confirm **Rafter** Section alignment - in the front, **Rafter** will overhang **Porch Post** by slightly". **Rafter** will also overhang the siding of Middle Gable Wall.

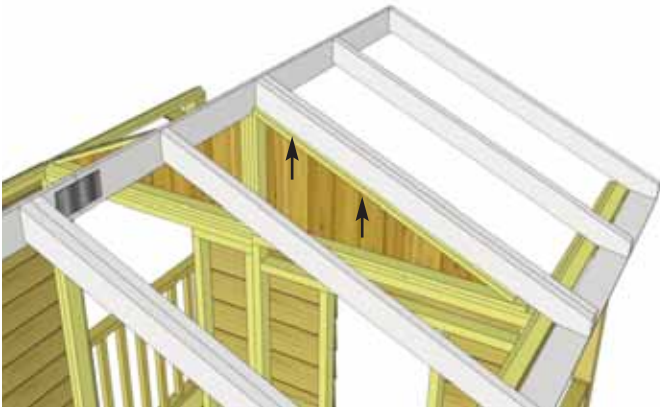

42. When **Rafter** Section is aligned correctly, tack **Rafter** Section temporarily down from **Middle Gable Wall** framing into **Rafter** with **2 - 2" screws**.

Hardware (Step 42)
S3 - 2" Screws
 x 2 total

Note: Metal Ridge Board is offset with 1st Rafter Section

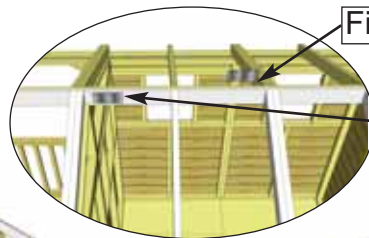

First Ridge Board Connector

Second Ridge Board Connector

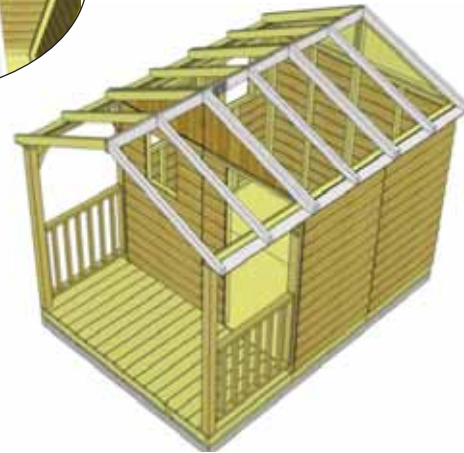

43. Place 2nd completed **Rafter** Section on gable wall framing. Position as per **Steps 39 - 42**.

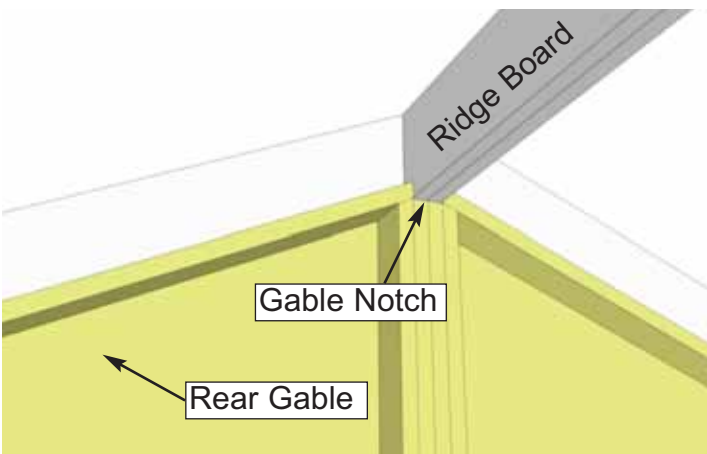

44. When both **Rafter** Sections are correctly aligned, **Ridge Boards** will sit in both the rear and middle gable notches. Front **Rafters** will overhang **Porch Posts**.

Important: Make sure Metal Ridge Board Connectors are offset to one another as illustrated below.

Expert Advice: It may be helpful to use some clamps to help hold Ridge Boards flush together while screwing

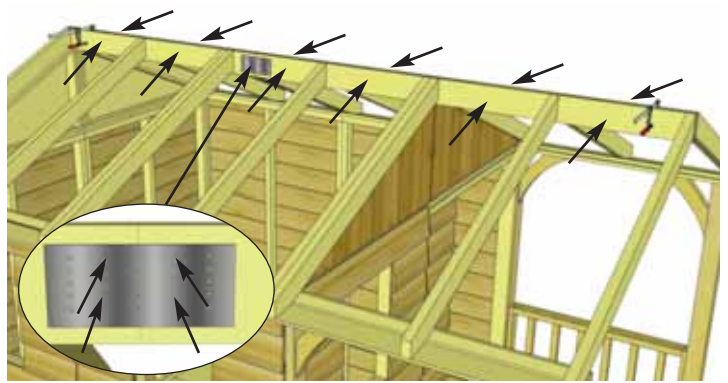
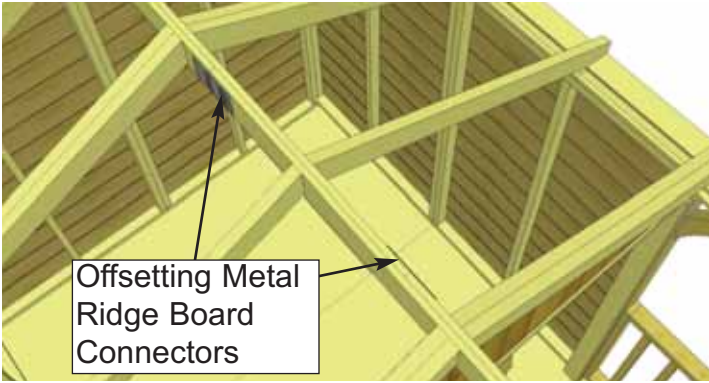

45. At the peak, align **Ridge Boards** so they are flush together and secure them with **12 - 1 1/4" screws**. To completely secure **Ridge Boards**, place **4 - 1 1/4" screws** into any of the remaining **Metal Ridge Board Connector** holes. Complete both sides. **Important:** If there is a gap between **Ridge Boards**, try pushing side walls closer together from outside. Walls should be 91" apart at top from inside of wall plate to wall plate.

Hardware (Step 45)
S2 - 1 1/4" Screws
 x 16 total

Important: If Gable framing does not line up with Rafters, remove temporary 2" screws from gable framing. Re-align gable and secure with 8 - 2" screws total.



46. With both **Ridge Boards** connected, completely secure **Rafters** to Rear **Gable** framing of **both rear and middle Gable Walls**. Use **8 - 2" screws**.

Hardware (Step 46)
S3 - 2" Screws
 x 16 total



47. With both **Ridge Boards** connected, completely secure **Rafters** to Front **Gable** framing of **both rear and middle Gable Walls**. Use **8 - 2" screws**.

Hardware (Step 47)
S3 - 2" Screws
 x 16 total

48. Attach **Rafters** in porch area into Top Plate of porch with **1 - 2 1/2" screw** per **Rafter**. Once again, measure 91" from inside of wall plate to wall plate for correct **Rafter** alignment prior to attaching. Drill pilot holes in rafters on angle first to prevent splitting and then screw down.

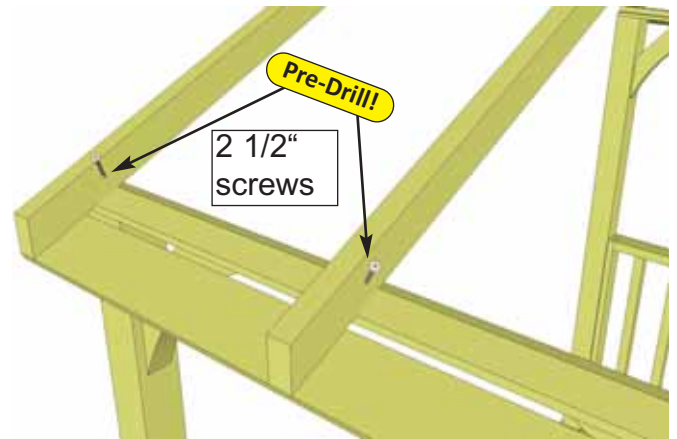

Hardware (Step 48)
S3 - 2" Screws
 x 4 total

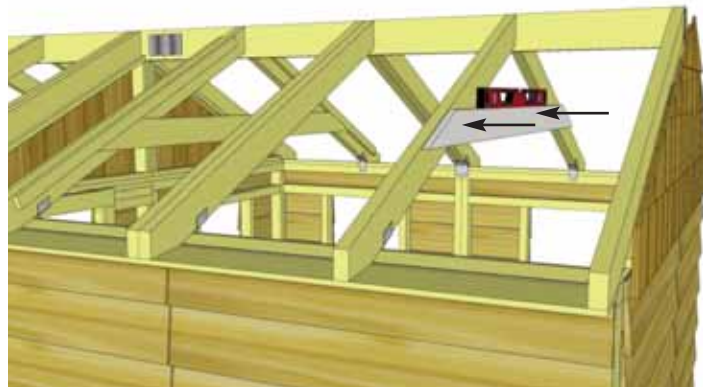

49. Roof Gussets are positioned on middle **Rafters**. Prior to attaching, make sure walls are properly aligned. Have two helpers push walls at the top from the outside of shed until inside measurement between front and rear plates is 91". Use a level to square **Gusset**. Attach Gusset with 4 - 2" screws. First **Gusset** will sit below Rafter Nailing Cleat, second flush with Rafter.

Parts (Step 49)
Roof Gussets
 (3/4" x 3 1/2" x 72") x 2
Hardware (Step 49)
S3 - 2" Screws
 x 8 total

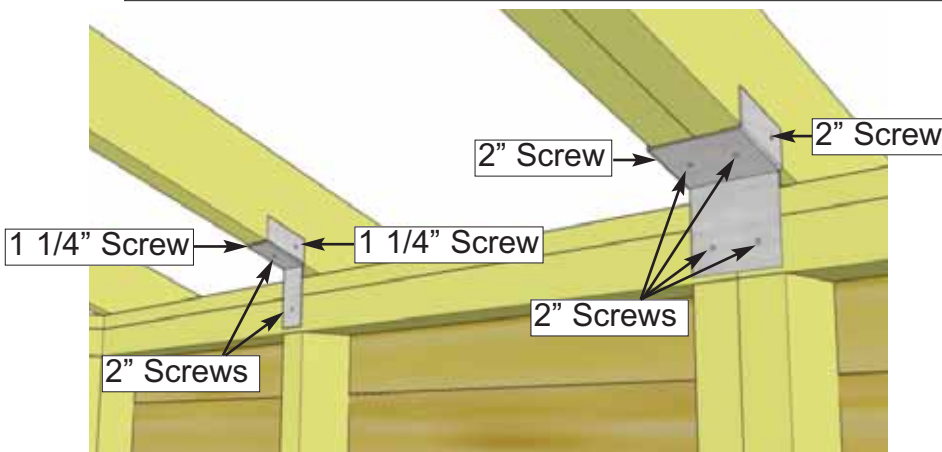

50. Attach all **Single** and **Double Rafter Brackets** where rafters meet **Top Wall Plates** inside of shed. Attach with **2 - 1 1/4" screws** and **2 - 2" screws** per **Single Bracket** and **6 - 2" screws** per **Double Bracket**.

Hardware (Step 50)
S2 - 1 1/4" Screws
 x 8 total
S3 - 2" Screws
 x 20 total
Y30 - Single Rafter Brackets
 x 4 total
Y31 - Double Rafter Brackets
 x 2 total

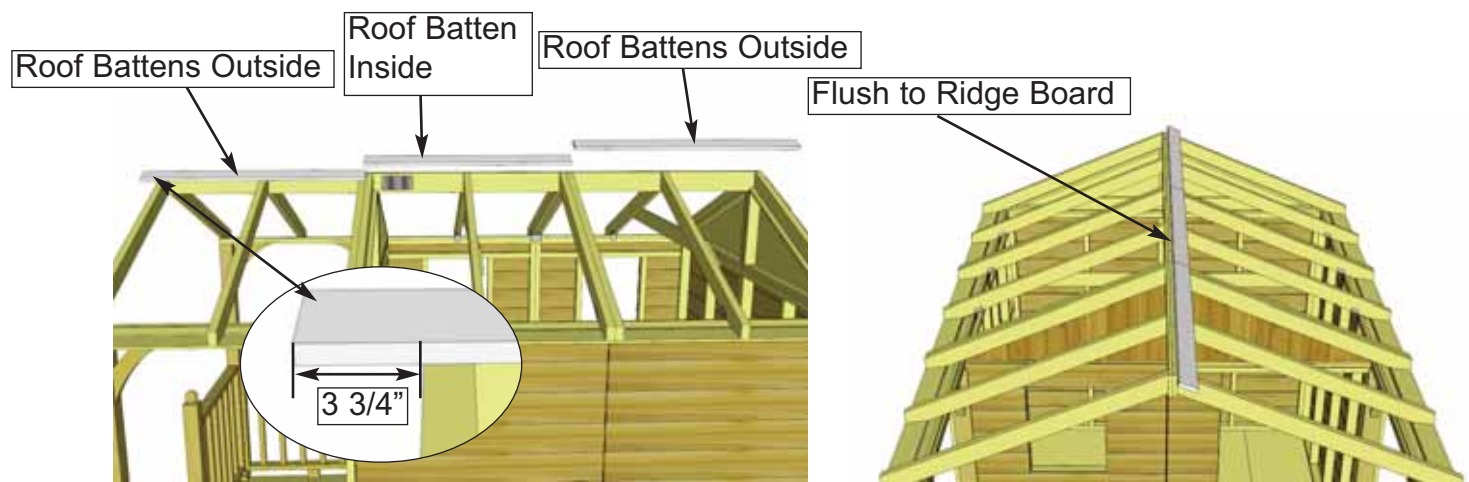

51. Locate 2 **Roof Battens Outside** and 1 **Roof Batten Inside** and place on roof Rafters. Place at top of Rafter section where Rafters and Ridge boards meet. Battens should be positioned with each end touching a doubled Rafter. Battens will overhang outside Rafters by 3 3/4".

Parts (Step 51 - 57)
Roof Battens Outside
 (3/4" x 3 1/2" x 49 1/4") x 16
Roof Battens Inside
 (3/4" x 3 1/2" x 45 1/2") x 8
Batten Spacer
 (3/4" x 1 1/2" x 14 1/8") x 12

Hardware (Steps 51 - 57)
S2 - 1 1/4" Screws
 92 x total

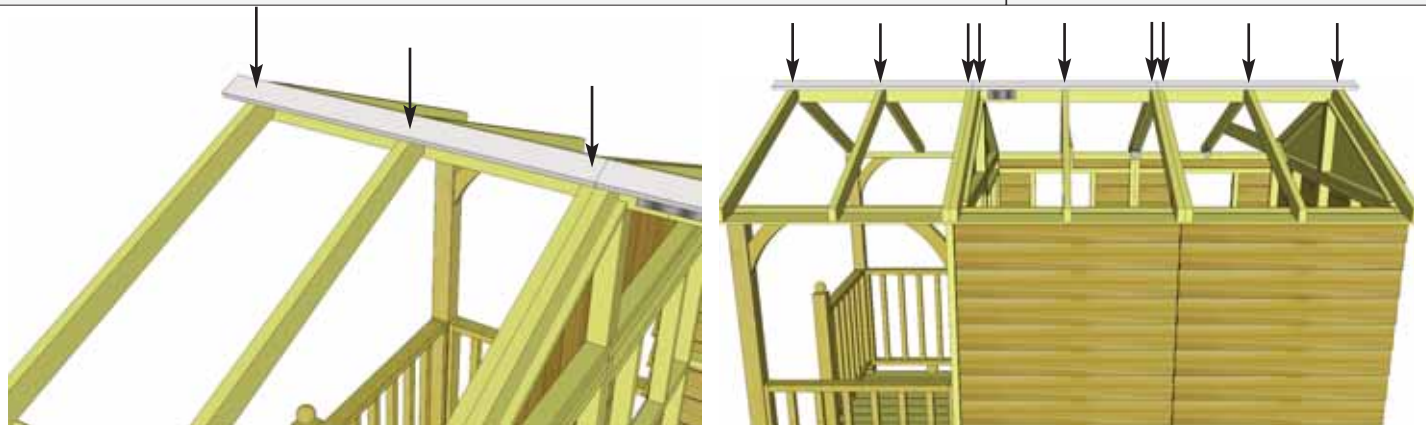

52. Attach each **Batten** to Rafters with 3 - 1 1/4" screws per Rafter section. **Important:** pre-drill pilot holes with 1/8" drill bit first to prevent splitting.

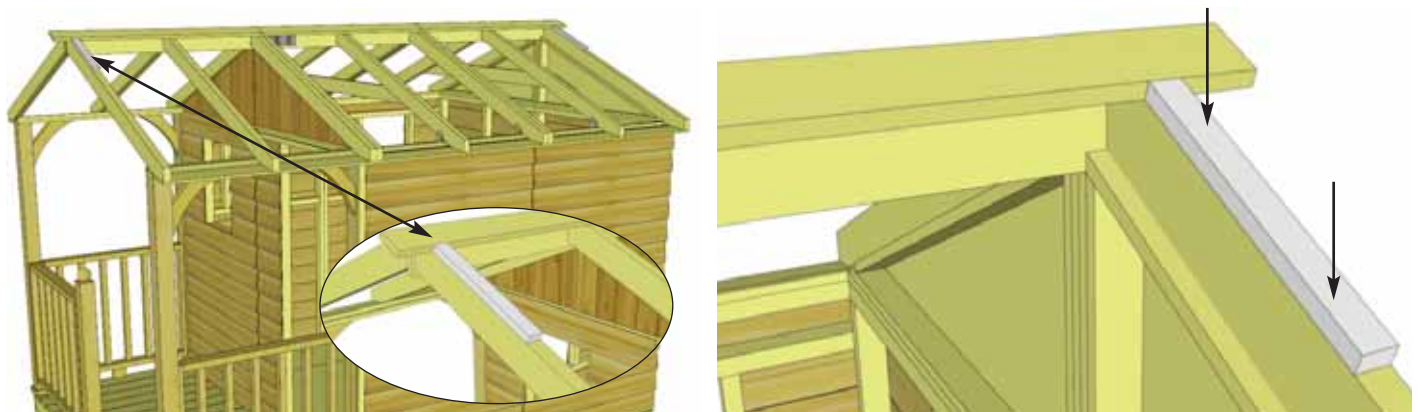

53. Place **Batten Spacer** flush with first set of Battens on outside Rafter. Batten Spacer allows you to line up next row of Battens. Attach each with **Batten Spacer** with 2 - 1 1/4" screws.



54. Locate **2 Outside Roof Battens** and **1 Inside Roof Batten**. Place outside Battens flush with Batten Spacers and overhanging outside Rafter by $3\frac{3}{4}$ ". Secure row of Battens to Rafters with **9 - 1 1/4"** screws (3 screws per Batten).

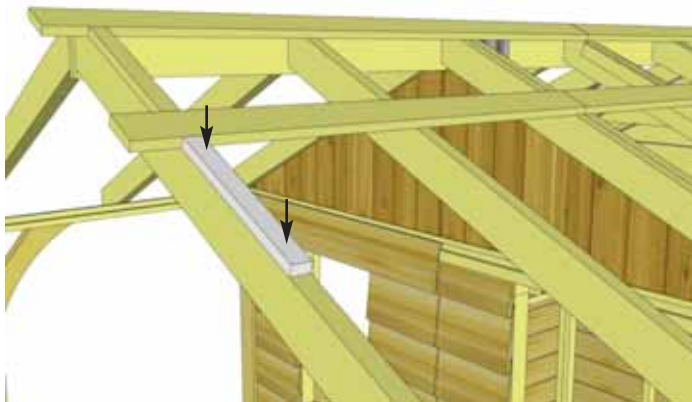

55. Locate another pair of **Batten Spacers** and position flush with second row of Battens. Attach Batten Spacers to outside Rafter with **2 - 1 1/4"** screws per **Spacer**. Locate 2 more **Outside Roof Battens** and 1 **Inside Roof Batten**, position Battens flush to **Batten Spacers**. Attach each **Batten** to Rafters with **3 - 1 1/4"** screws (9 total).

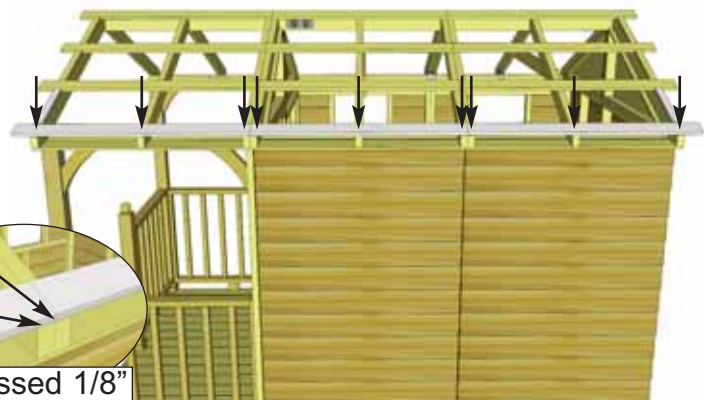
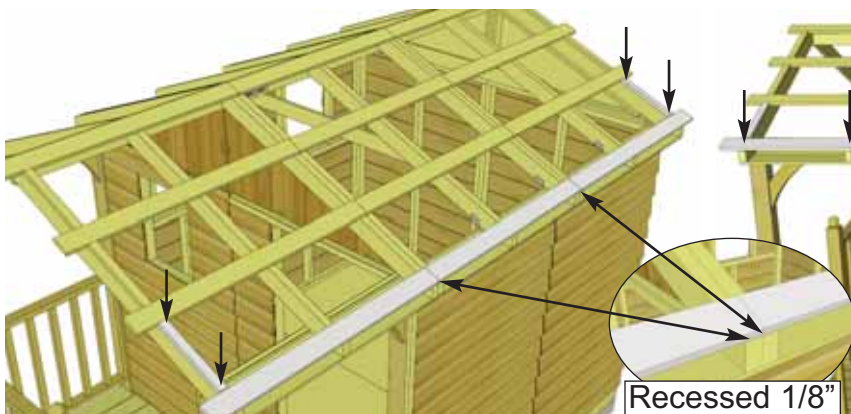

56. Locate another pair of **Batten Spacers** and position flush with third row of Battens. Attach Batten Spacers to outside Rafter with **2 - 1 1/4"** screws per **Spacer**. Locate 2 more **Outside Roof Battens** and 1 more **Inside Roof Batten**. Position Battens flush to **Batten Spacers**, **Battens** should be recessed $\frac{1}{8}$ " from end of Rafters. Attach each **Battens** to Rafters with **3 - 1 1/4"** screws (9 total).

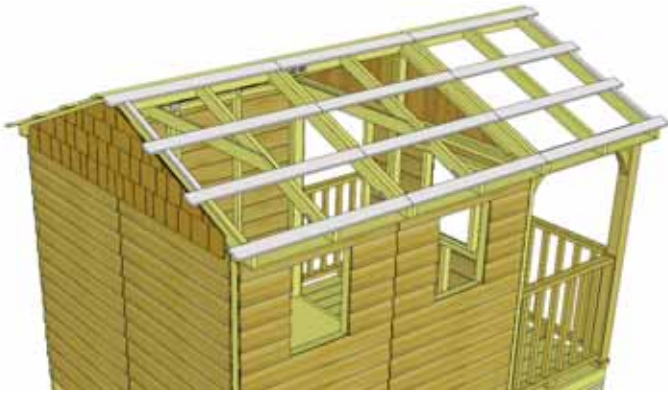

57. Repeat **Steps 51 - 56** to complete Batten Section on opposite side of roof with remaining **Battens** and **Batten Spacers**.

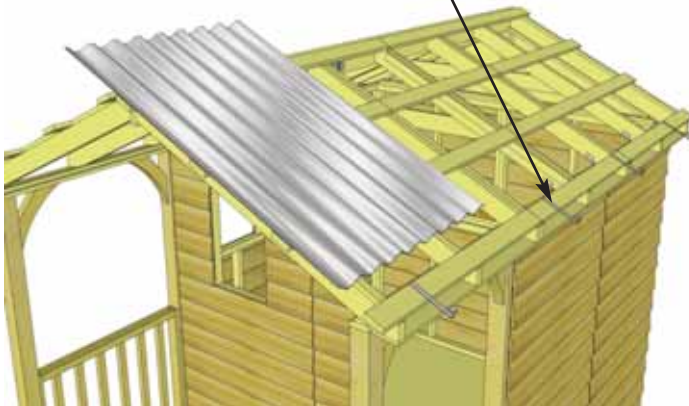
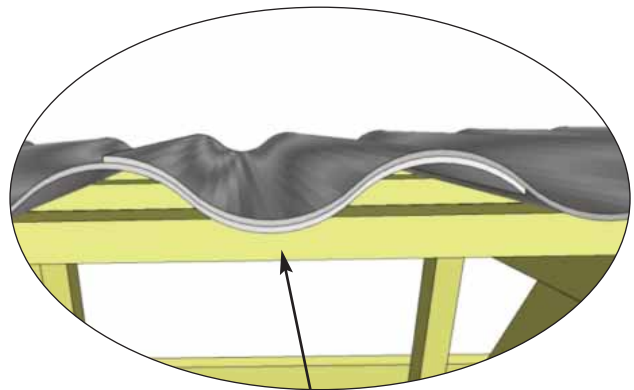
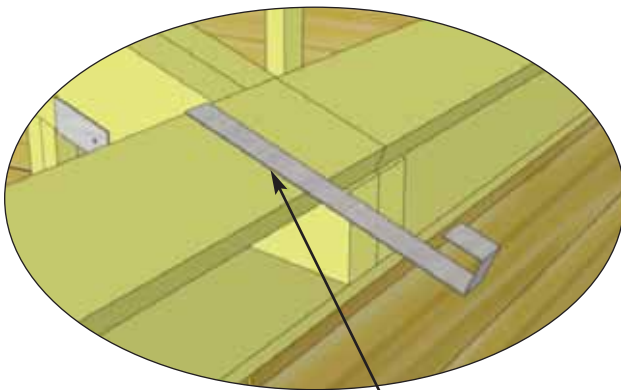

58. Locate 4 **Metal Roof Panels** and 4 **Metal Roof Hangars**. To temporarily hold the **Metal Roof Panels** in place, hook a **Metal Roof Hangar** onto the lowest Batten, approximately where the center of the panels will be. Place first **Metal Roof Panel** on Battens and into Hangar. Do not fasten panels down until **Step 62**. Place remaining 3 panels and hangars on the same way. Metal Roof Panels will overlap each other.

Parts (Step 58)
Metal Roof Panels
 (39" wide x 61" long) x 4
 Hardware (Step 58)
Y38 - Metal Roof Hangars
 x 4 total

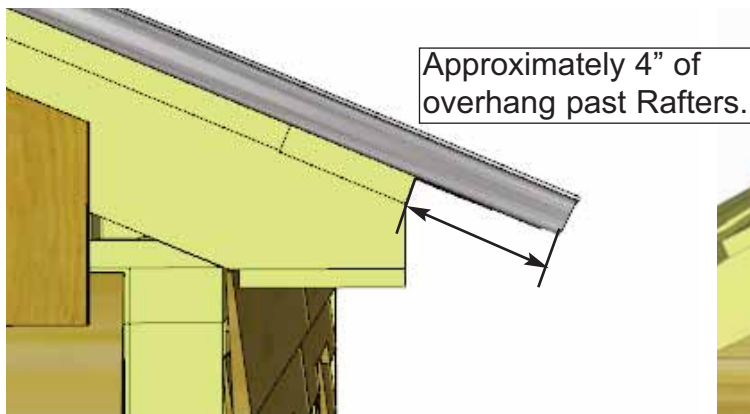

59. Overhang the **Metal Roof Panels** past the **Battens** on front and rear of shed by approximately 1". Adjust panels side-to-side to achieve desired width. Overall width past the **Battens** can vary from 1" - 3" depending on your preference. The overhang over the side of the shed will be set by the **Metal Roof Hangars**, but should be approximately 4" on side of shed.



60. Once the Metal Roof Panels are spaced correctly from side-to-side and top-to-bottom, lift 3 panels up and run a bead of caulking down the overlapping seams of each panel to seal the joints. Place panels down one by one once seam is caulked. You will likely need assistance from a helper for this step. Caulk each seam.

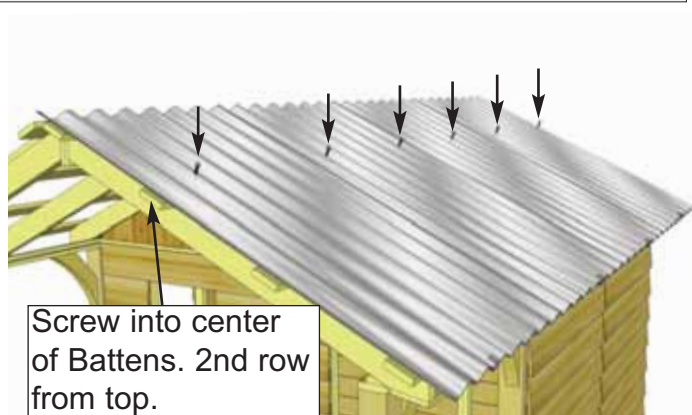

61. Using **6 - 2" Metal Screws** and **1/4" Nut Driver** (included), partially secure **Metal Roof Panels** to 2nd row of **Battens** from top. Only fasten screws halfway so that **Metal Roof Hangars** can be removed in **Step 62.** Metal screw is self-tapping, screw into center of Battens

Hardware (Step 61)
2" - Metal Roof Screws
 x 6 total

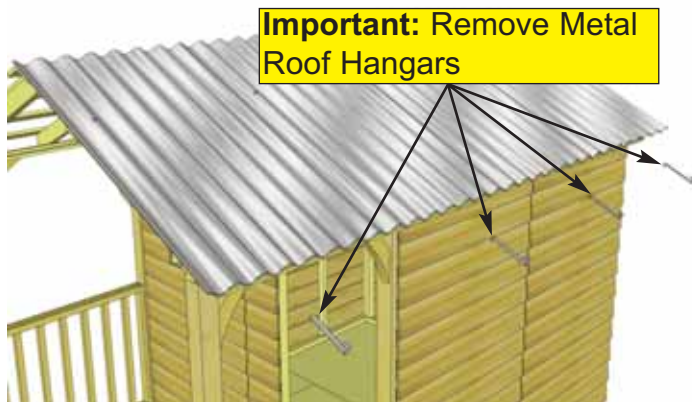

62. Before fully fastening **Metal Roof Panels** down, remove the **Metal Roof Hangars** and insert **Foam Enclosures** between **Metal Roof Panels** and **Battens** at the bottom of the roof. Enclosures will prevent moisture and unwanted bugs, etc from entering your shed through here.

Parts (Step 62)
Foam Enclosures
 (Several Pcs)

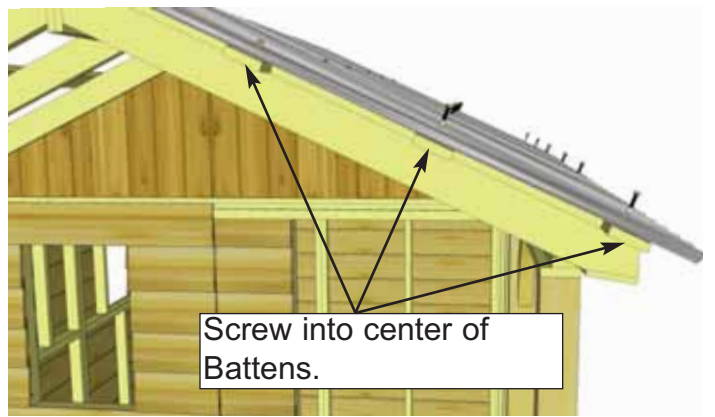
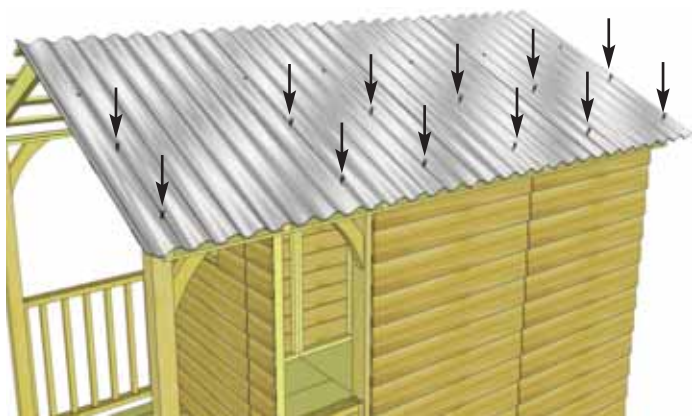

63. Using **12 - 2" Metal Screws** and 1/4" Nut Driver, secure **Metal Roof Panels** down to lower 2 rows of **Battens**. Leave the top row unsecured for now to secure Ridge Cap later in **Step 66**. Tighten screws in middle row that were partially secured in **Step 61**. Do not overtighten!

Hardware (Step 63)
2" - Metal Roof Screws
 x 12 total

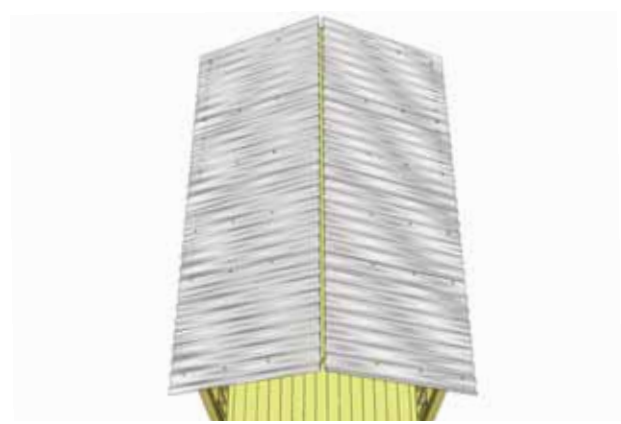

64. Repeat **Steps 58 - 63** to complete opposite side of Metal Roof.



65. Locate remaining **Foam Enclosures**. Place **Foam Enclosures** at the top of roof panels. **Foam Enclosures** prevent moisture from coming in through the top of your shed.

Parts (Step 65)
Foam Enclosures
 (Several Pcs)



66. Place 3 **Metal Ridge Caps** onto apex of roof. Evenly space from front to back of your shed, Metal Ridge Caps will overlap each other. Overhang the cap approximately 1" - 2" past each end. When **Metal Ridge Caps** are correctly positioned, secure with **12 - 2" Metal Ridge Screws** (6 per side). Screw into center of final **Batten**. Do not overtighten!

Parts (Step 66)
Metal Ridge Caps
 (60" long) x 3

Hardware (Step 66)
2" - Metal Ridge Screws
 x 12 total

D. Miscellaneous Section - Part 1

Exploded view of all parts necessary to complete the first part of the Miscellaneous Section. Identify all parts prior to starting.

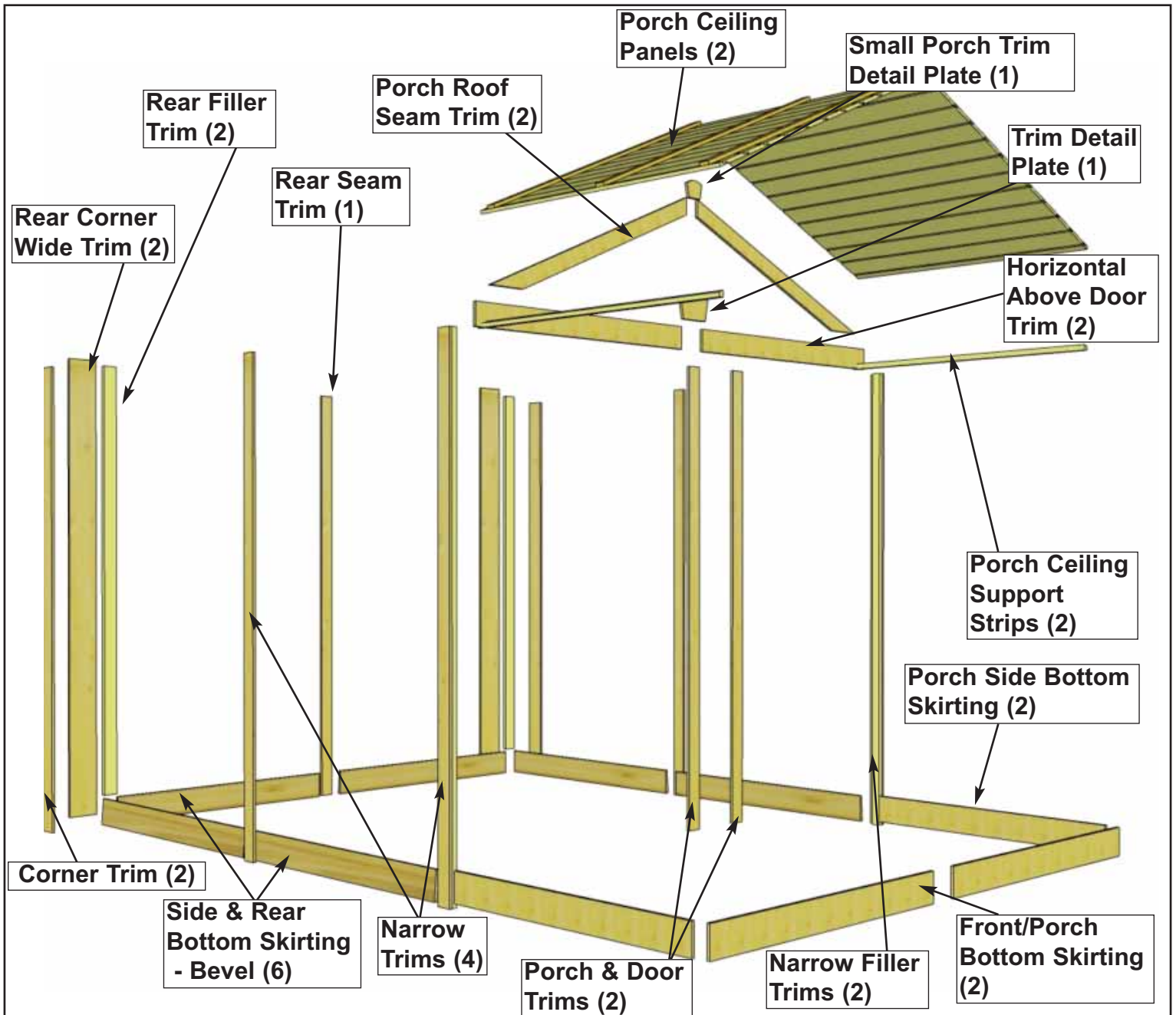

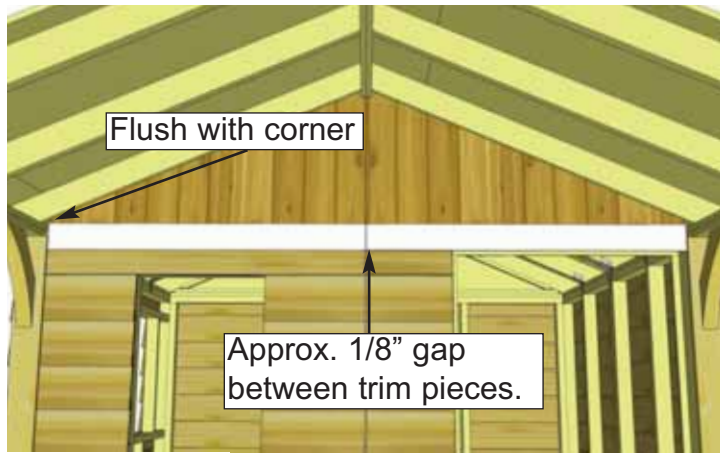
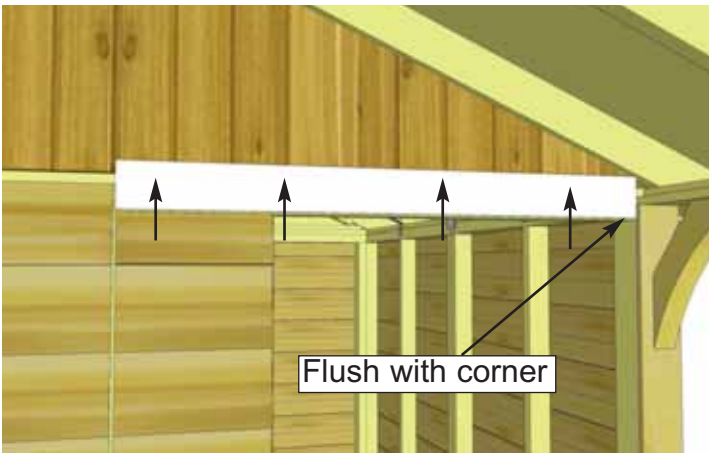

67. Attach **Horizontal Above Door Trim** with right side piece aligned flush with the top corner of doorway. Leave 1/8" gap between trim pieces, gap will be covered by a detail plate in **Step 81**. Attach with **4 - 1 1/2" Finishing Nails** per piece.

Parts (Steps 67)
Horizontal Above Door Trim
 (1/2" x 3 1/2" x 44") x 2

Hardware (Steps 67)
N1 - 1 1/2" Finishing Nails
 x 8 total

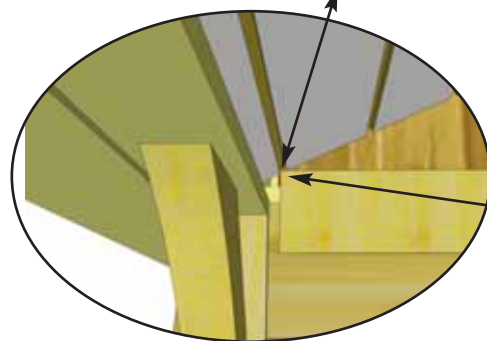
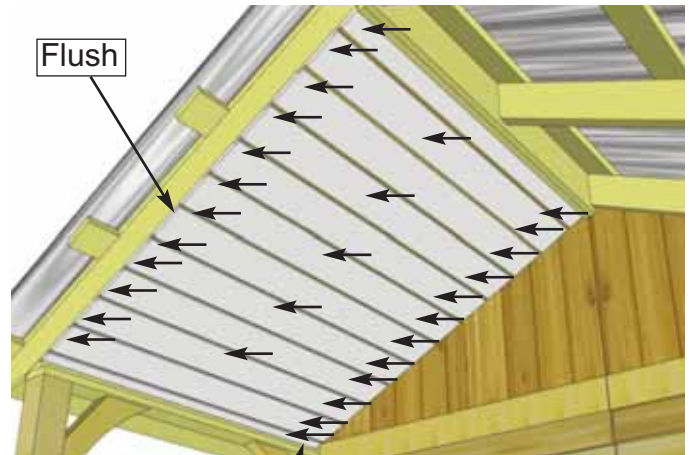

Corner of Horizontal Above Door Trim rests in first channel.

68. Position **Porch Ceiling Panels** underneath rafters with channels facing downward. To fit with the rafter spacing, there is a Left and a Right Panel. This is indicated by a sticker on the back of each panel. The left panel will go onto the left side of the porch roof when viewing the shed from the front.

The corner of the Horizontal Above Door Trim will rest in the first channel of the Porch Ceiling Panel. You will need a helper to hold the panel in place while you attach with **1 1/2" Finishing Nails** (27 per side). Attach one nail through both ends of each panel strip into the rafters above. It may be helpful to add a few nails to the center rafter. Attach other panel the same.

Parts (Steps 68)
Porch Ceiling Panels
 (1/2" x 44 1/2" x 48 1/2") x 2

Hardware (Steps 68)
N1 - 1 1/2" Finishing Nails
 x 54 total

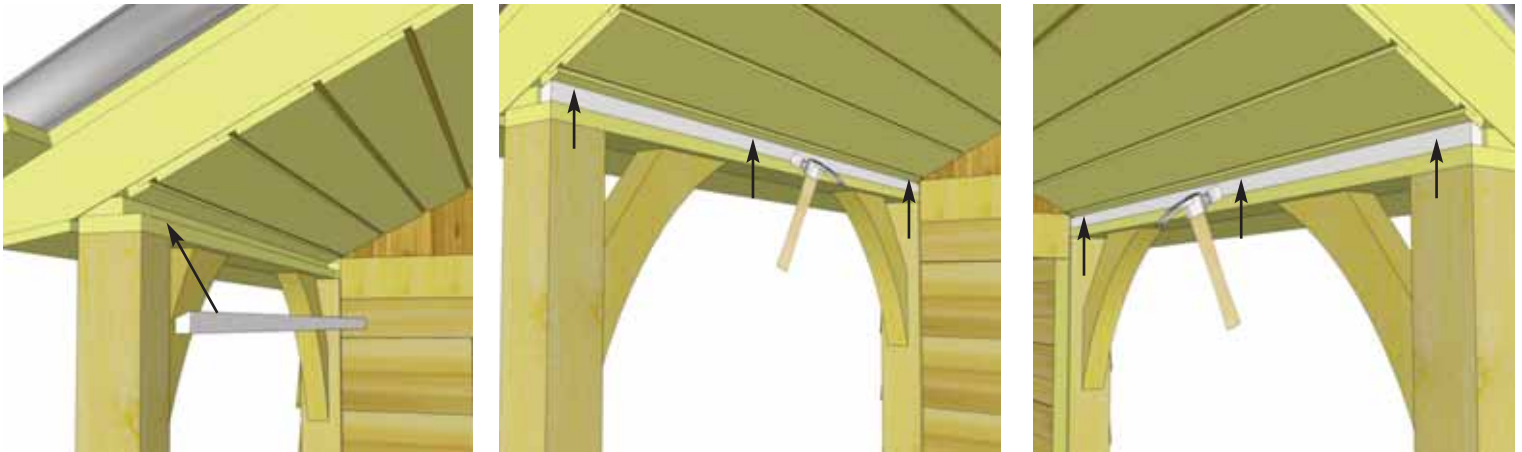

69. Insert **Porch Ceiling Support Strips** - Angle Edge Cut into the gap between the top of the Porch Rail Section and the Porch Ceiling Panel. Gently tap into place with a hammer. Once in place, attach each piece with **3 - 1 1/2" Finishing Nails** up through the Porch Rail Section into the Support Strips.

Parts (Steps 69)
Porch Ceiling Support Strips
 (1" x 1" x 45 1/2") x 2

Hardware (Steps 69)
N1 - 1 1/2" Finishing Nails
 x 6 total

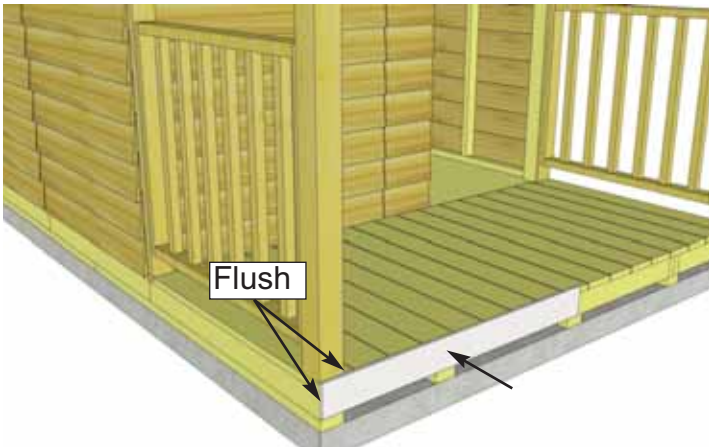

70. Attach **Front Bottom Skirting** around the base of the shed. Skirting will hide floor framing. Start with Front Skirting positioned flush with the top of the deck boards and the side of the floor frame. Attach with **6 - 1 1/2" Finishing Nails** per piece.

Parts (Steps 70)
Front Bottom Skirting
 (1/2" x 4 1/2" x 48") x 2
Hardware (Steps 70)
N1 - 1 1/2" Finishing Nails
 x 12 total

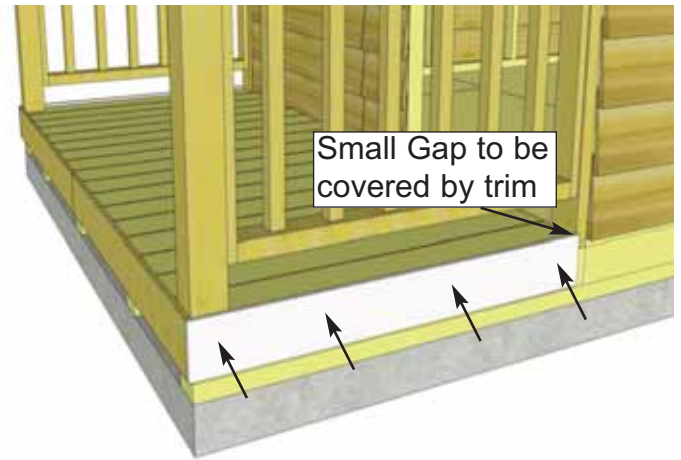
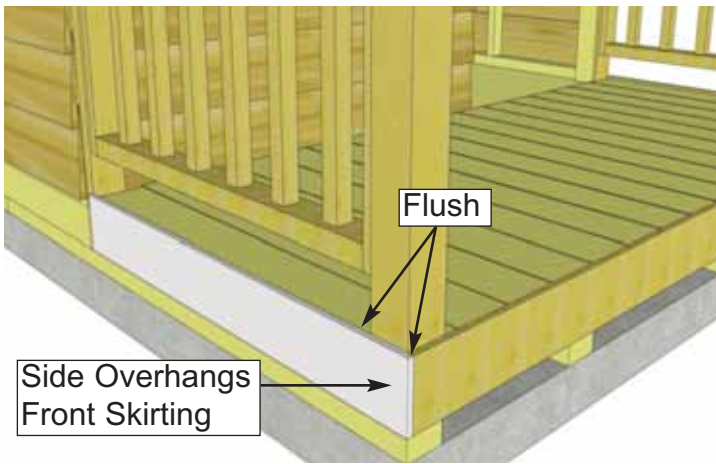

71. Position **Porch Side Bottom Skirting** on the side of the shed. The piece on the porch section will overlap the Front Skirting. When aligned there will be a gap on the shed side of the porch, this will be covered by trim pieces in **Step 77**. Attach with **4 - 1 1/2" Finishing Nails** per piece.

Parts (Steps 71)
Porch Side Bottom Skirting
 (1/2" x 4 1/2" x 44 1/2") x 2
Hardware (Steps 71)
N1 - 1 1/2" Finishing Nails
 x 8 total



72. Position **Rear Bottom Skirting - Bevel** around the base of the shed. Bevel is thicker at butt and thinner at top of board. Skirting will hide floor framing. Gaps on side will be covered by Narrow & Wide Trim pieces later. Start on side walls first and attach with **4 - 1 1/2" Finishing Nails** per piece.

Parts (Steps 72)
Rear Bottom Skirting- Bevel
 (3/4" x 4 1/2" x 45 1/4") x 6

Hardware (Steps 72)
N1 - 1 1/2" Finishing Nails
 x 36 total

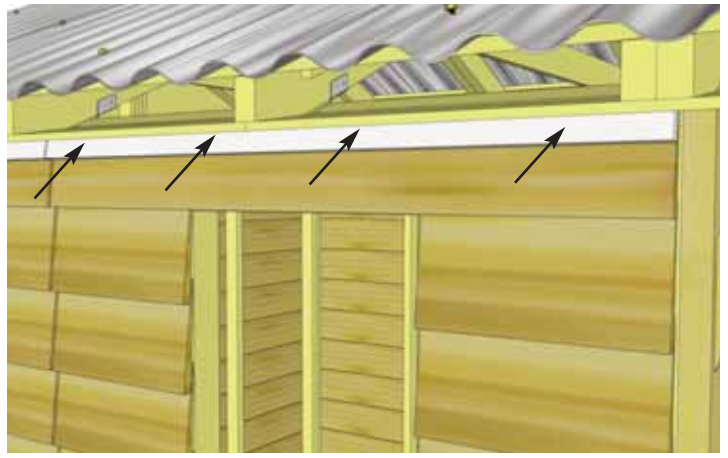

73. Trim out side walls by attaching **Top Wall Trim**. Position with thick end of Bevel downwards at top of wall, tight against Soffits. Attach with **4 - 1 1/2" Finishing Nails** per piece. Complete both sides

<p><u>Parts (Steps 73)</u> Top Wall Trim (3/4" x 1 1/2" x 45 1/4") x 4</p>	<p><u>Hardware (Steps 73)</u> N1 - 1 1/2" Finishing Nails x 16 total</p>
---	---

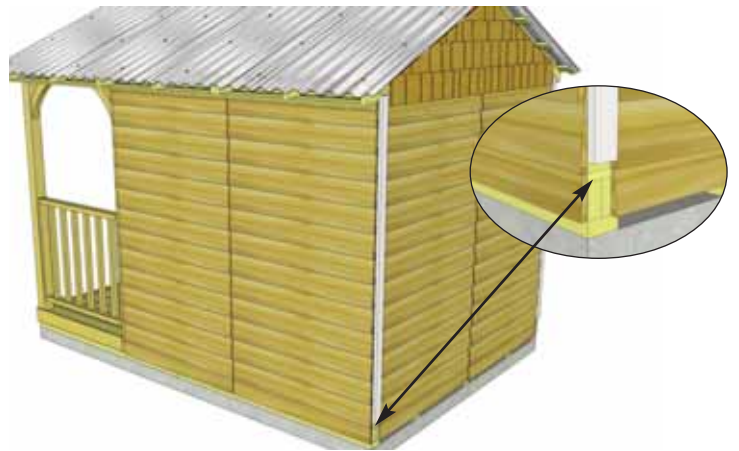

74. Attach **Rear Filler Trims** to rear walls, positioned flush with siding and bottom skirting. Attach with **8 - 1 1/2" Finishing Nails**.

<p><u>Parts (Steps 74)</u> Rear Filler Trims (7/8" x 2 1/2" x 75") x 2</p>	<p><u>Hardware (Steps 74)</u> N1 - 1 1/2" Finishing Nails x 16 total</p>
---	---



75. Position **Corner Trim** in rear corner and **Wide Corner Trim** over **Filler Trim**. Prior to attaching, do a dry run with Narrow Trim butted up tight underneath the Soffit. Position Wide Trim evenly with Narrow Trim at bottom. Narrow Trim will cap Wide Trim. Attach with **8 - 1 1/2" Finishing Nails** per piece. Repeat for other opposite rear corner.

<u>Parts (Steps 75)</u> Corner Trims (1/2" x 3 1/2" x 78 1/2") x 2 Wide Corner Trim (1/2" x 5 1/2" x 81 1/2") x 2
<u>Hardware (Steps 75)</u> N1 - 1 1/2" Screws x 32 total



76. Position **Narrow Filler Trims** in gap between shed and porch. Attach with **8 - 1 1/2" Finishing Nails** per piece.

<u>Parts (Steps 76)</u> Narrow Filler Trims (7/8" x 1 1/2" x 78 1/2") x 2	<u>Hardware (Steps 76)</u> N1 - 1 1/2" Finishing Nails x 16 total
--	--

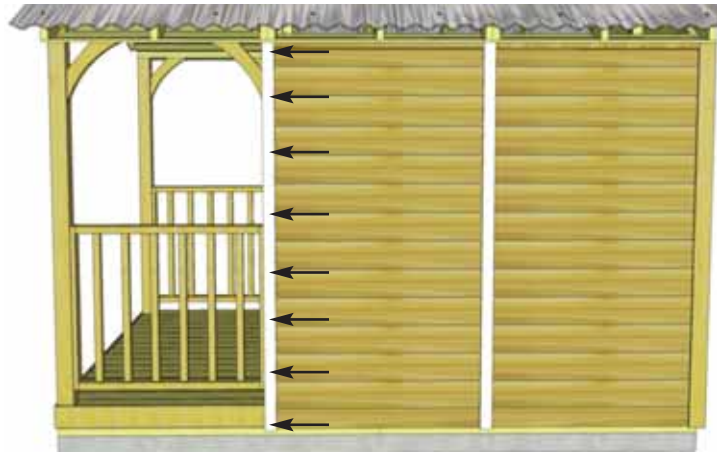

77. Attach four remaining **Narrow Trims** to both sides of the shed. Use **8 - 1 1/2" Finishing Nails** per piece.

Parts (Steps 77)
Narrow Trims
 (1/2" x 2 1/2" x 78 1/2") x 4

Hardware (Steps 77)
N1 - 1 1/2" Finishing Nails
 x 32 total



78. Attach **Rear Wall Seam Trim** where back wall panels meet. Secure with **8 - 1 1/2" Finishing Nails**.

Parts (Steps 78)
Rear Wall Seam Trim
 (1/2" x 2 1/2" x 77 1/2") x 1

Hardware (Steps 78)
N1 - 1 1/2" Finishing Nails
 x 8 total

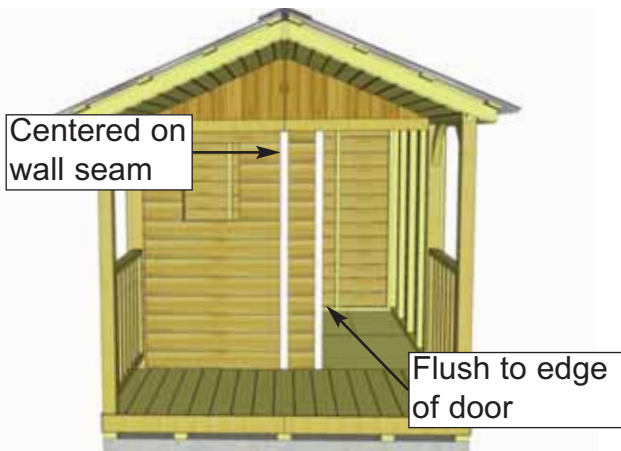

79. Attach both **Porch & Door Trims** to front walls. Secure with **6 - 1 1/2" Finishing Nails**.

Parts (Steps 79)
Porch & Door Trims
 (1/2" x 2 1/2" x 72") x 2

Hardware (Steps 79)
N1 - 1 1/2" Finishing Nails
 x 12 total



80. Position **Porch Roof Seam Trim** so the sharp angle of each piece is tight into the corner between Porch Ceiling and Horizontal Above Door Trim. Attach with **4 - 1 1/2" Finishing Nails** per piece.

<u>Parts (Steps 80)</u>
Porch Roof Seam Trim (1/2" x 2 1/2" x 45 7/8") x 2
<u>Hardware (Steps 80)</u>
N1 - 1 1/2" Finishing Nails x 8 total

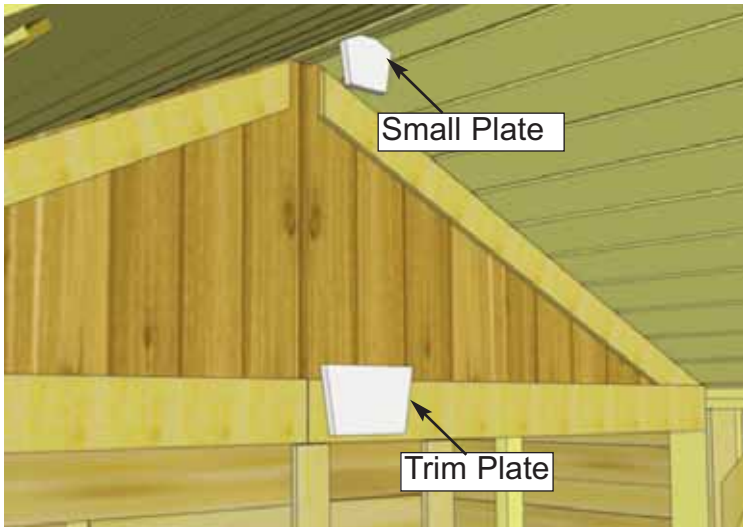

81. Position **Small Porch Detail Plate** and one **Facia Detail Plate** to cover trim seams. Attach with **4 - 1 1/2" Finishing Nails** per piece.

<u>Parts (Steps 81)</u>
Small Porch Detail Plate x 1 Facia Detail Plate x 1
<u>Hardware (Steps 81)</u>
N1 - 1 1/2" Finishing Nails x 8 total

E. Miscellaneous Section - Part 2

Exploded view of all parts necessary to complete the second part of the Miscellaneous Section. Identify all parts prior to starting.

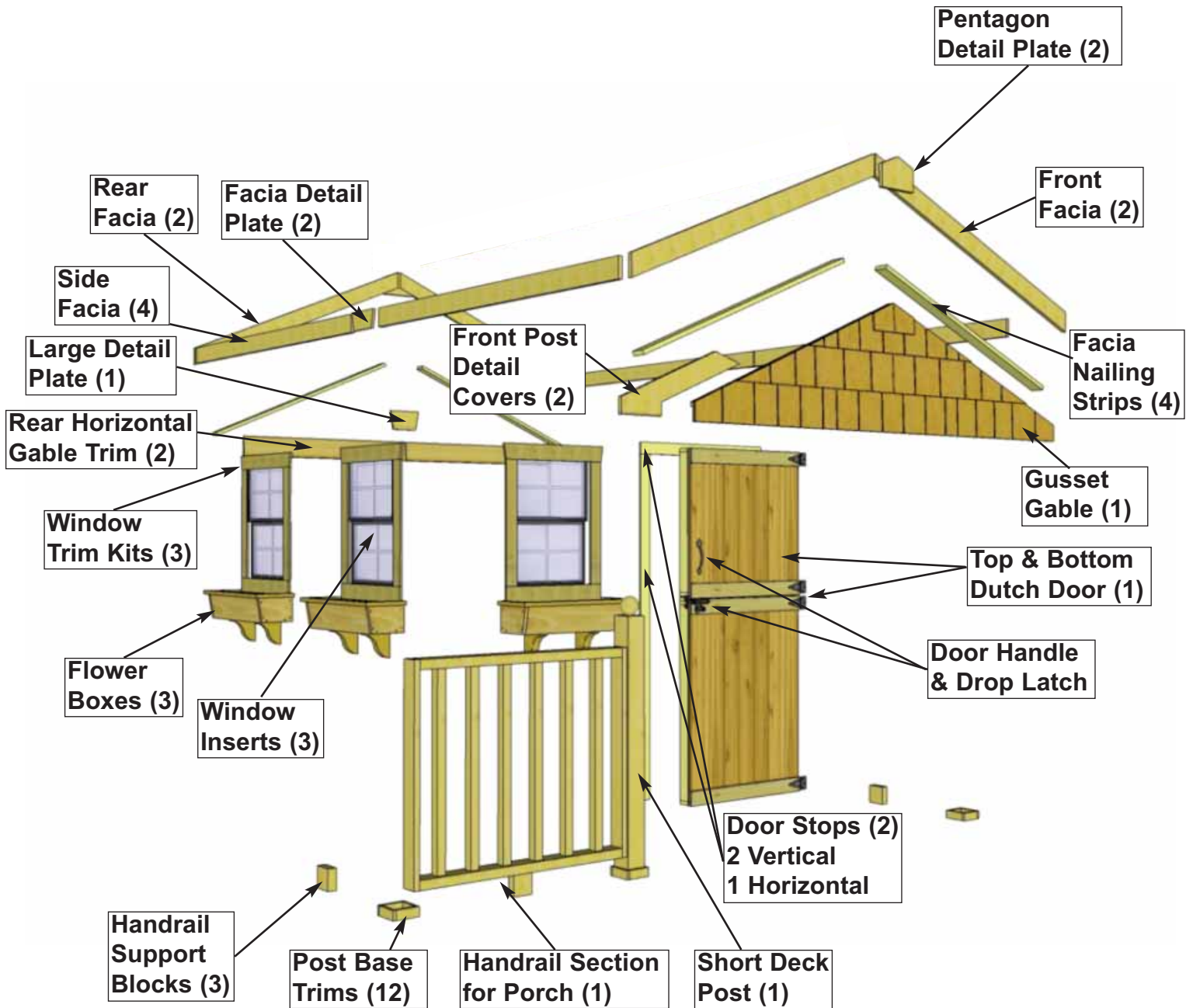

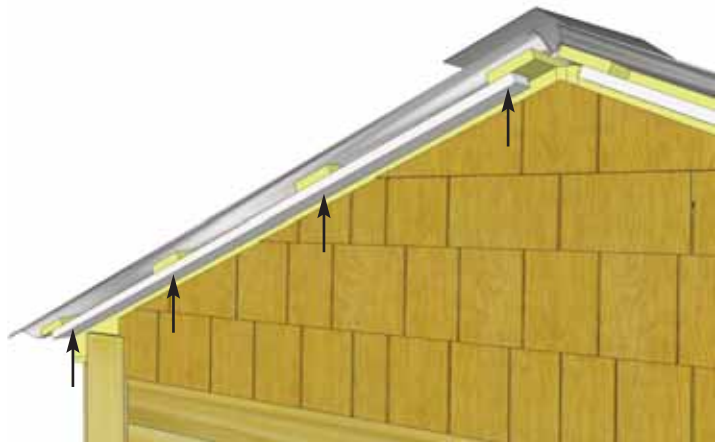

82. Attach two **Roof Nailing Strips** to the underside of the roof plywood on rear of shed. Align strips flush with plywood ends. Fasten with **4 - 1 1/4" Screws** per piece.

Parts (Steps 82)
Roof Nailing Strips
 (3/4" x 2 1/2" x 53") x 2

Hardware (Steps 82)
S2 - 1 1/4" Screws
 x 8 total



83. Attach remaining two **Roof Nailing Strips** to the underside of the roof plywood on front of shed. These strips will be pushed tight against the rafters unlike the Rear Nailing Strips. Fasten with **4 - 1 1/4" Screws** per piece.

Parts (Steps 83)
Roof Nailing Strips
 (3/4" x 2 1/2" x 53") x 2

Hardware (Steps 83)
S2 - 1 1/4" Screws
 x 8 total

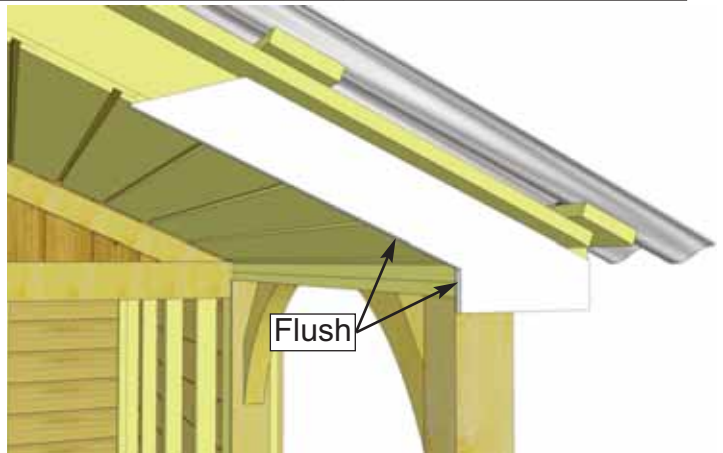

84. Position **Front Post Detail Covers** onto bottom corner of rafters, tight underneath Fascia Nailing Strips. Covers should be approximately flush with the bottom of the Porch Roof, the inside of the 4x4 Porch Post, and the Rafter ends. Attach with **4 - 1 1/2" Finishing Nails** per piece.

Parts (Steps 84)
Front Post Detail Covers
 (1/2" x 5 1/2" x 23 1/4") x 2

Hardware (Steps 84)
N1 - 1 1/2" Finishing Nails
 x 8 total



85. Position the **Gusset Gable** onto the front of the shed. Push Gable plywood up tight under roof plywood and against Roof Nailing Strip. Screw through the shingles of the Gusset Gable horizontally into the Roof Nailing Strip with **8 - 2 1/2" screws**.

Parts (Steps 85)
Gusset Gable x 1
Hardware (Steps 85)
S1 - 2 1/2" Screws
x 8 total

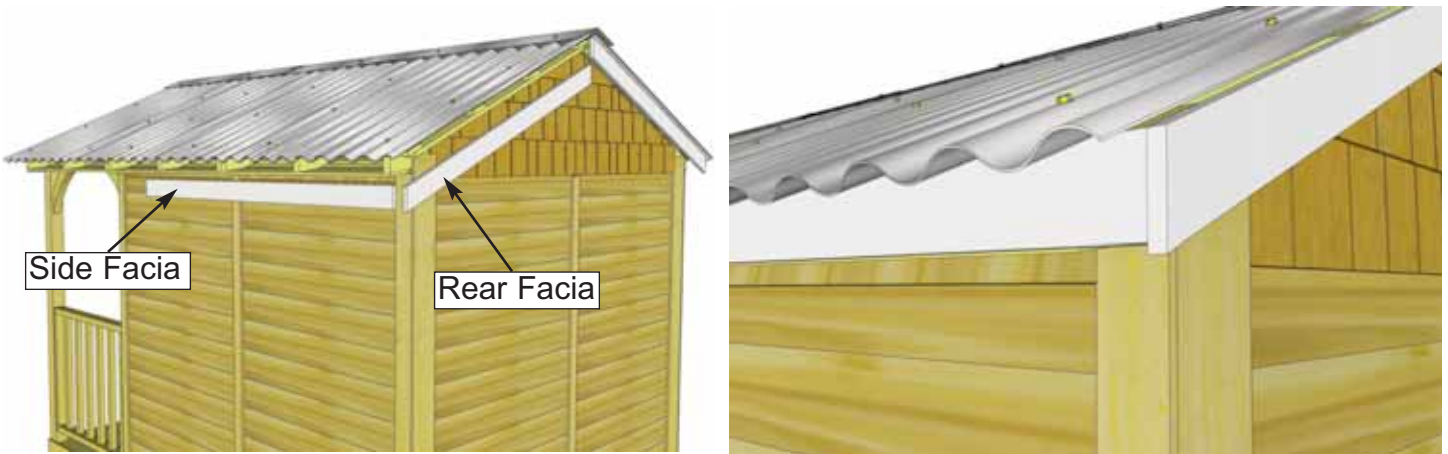

Side Facia

Rear Facia

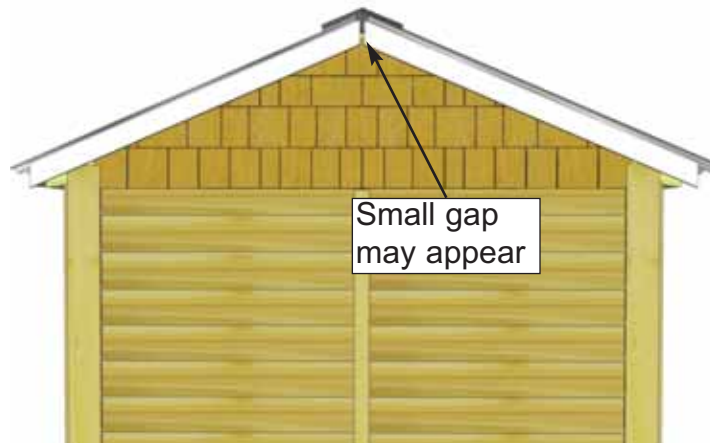

Small gap may appear

86. Position **Rear Facia** - angle cut ends tight underneath roof shingles and tight against Nailing Strips. Temporarily position **Side Facia** for a dry run to help you correctly position Rear Facia before attaching.

Attach Rear Facia to Nailing Strips with **8 - 1 1/2" Finishing Nails** per piece. A small gap may appear where Rear Facias come together at peak. This gap will be covered in **Step 90**.

Parts (Steps 86 - 89)
Front & Rear Facia
(3/4" x 3 1/2" x 58") x 4
Side Facia
(3/4" x 3 1/2" x 71 3/4") x 4
Hardware (Steps 86)
N1 - 1 1/2" Finishing Nails
x 16 total

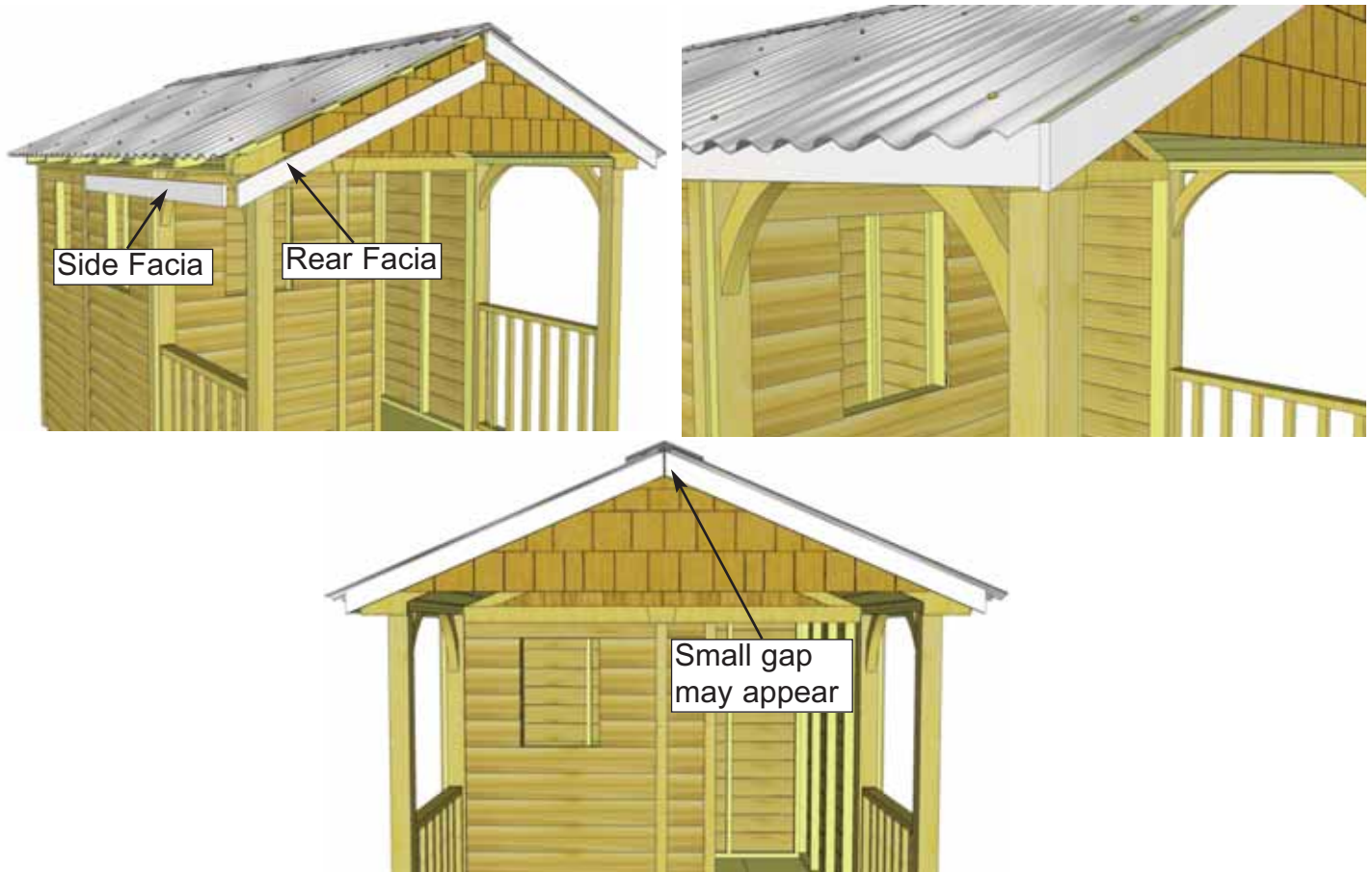

87. Position **Front Facia** - angle cut ends tight underneath roof shingles and tight against Nailing Strips. Temporarily position **Side Facia** for a dry run to help you correctly position Front Facia before attaching.

Attach Front Facia to Roof Plywood with **8 - 1 1/2" Finishing Nails** per piece. A small gap may appear where Front Facias come together at peak. This gap will be covered in **Step 90**.

Hardware (Steps 87)
N1 - 1 1/2" Finishing Nails
 x 16 total

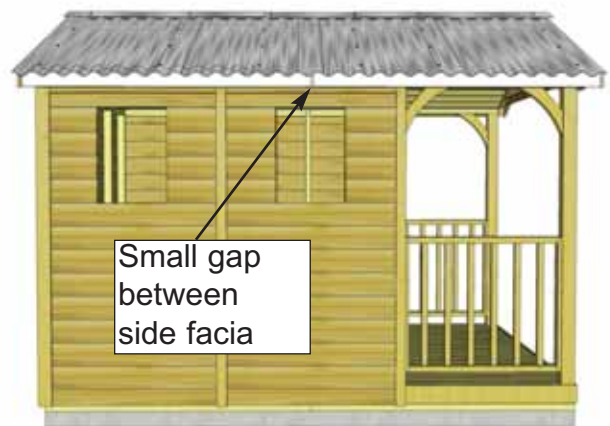

88. Attach **Side Facia** to rafter ends. There are 2 Facia pieces per side. A small gap may appear between Facias, which will be covered in **Step 79**. Secure with **8 - 1 1/2" Finishing Nails** per piece.

Hardware (Steps 88)
N1 - 1 1/2" Finishing Nails
 x 32 total

89. Locate **Horizontal Gable Trims** for rear of shed. Position equally over Gable and Wall seam. Attach each piece with **6 - 1 1/2" Finishing Nails**.



<u>Parts (Step 89)</u> Horizontal Gable Trims (3/4" x 4 1/2" x 43 3/8") x 2	<u>Hardware (Step 89)</u> N1 - 1 1/2" Finishing Nails x 6 total
--	--

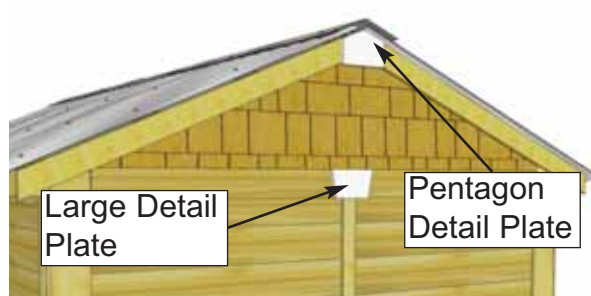
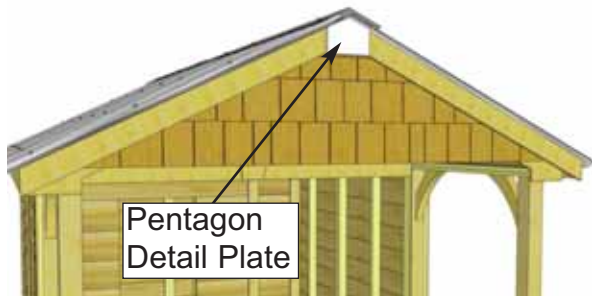
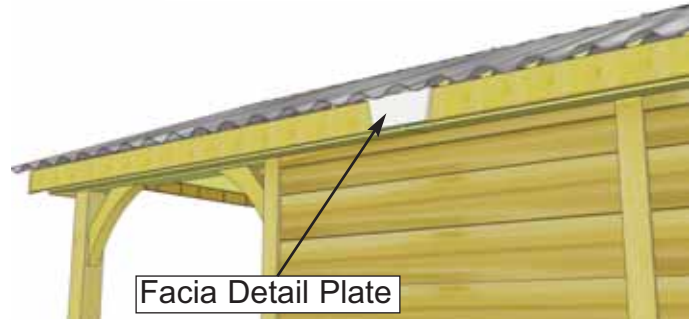
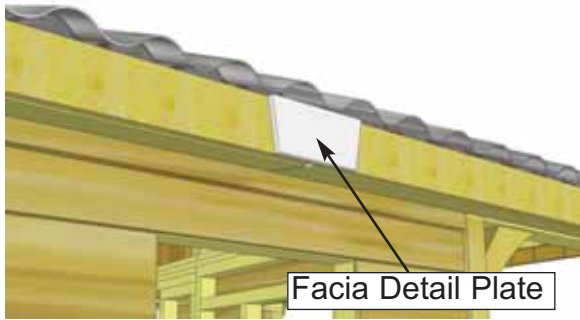

90. Attach two **Facia Detail Plates** and both **Pentagon Detail Plates** to cover seams where Facia pieces come together. Secure with **4 - 1 1/2" Finishing Nails** per piece.

<u>Parts (Steps 90)</u> Facia Detail Plates x 2 Pentagon Detail Plates x 2 Large Detail Plate x 1	<u>Hardware (Steps 90)</u> N1 - 1 1/2" Finishing Nails x 20 total
---	--

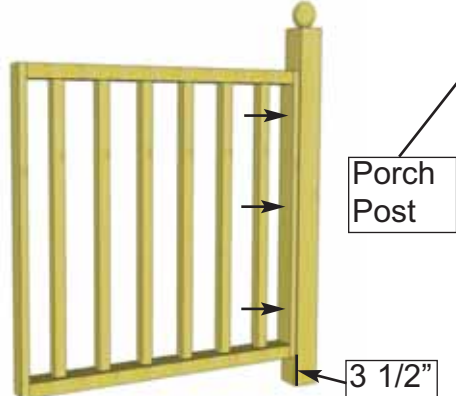

91. To complete porch, attach **Short Deck Post** and **Handrail Section** together with **3 - 2" Screws**. Measure **3 1/2"** from bottom of post to align rail. Place Post/Handrail section on deck. Attach rail to Porch Post with **3 - 2" Screws**.

<u>Parts (Steps 91)</u> Short Deck Post (3 1/2" x 3 1/2" x 42") x 4 Handrail Section x 1
<u>Hardware (Steps 91)</u> S3 - 2" Screws x 6 total

92. Toe-nail **Short Post** to Deck with **3 - 2 1/2" Screws**. Drill pilot holes to avoid splitting posts.
Note: Ensure the screws are low enough on the post to be covered by Post Base Trim in **Step 101**.

Hardware (Steps 92)
S1 - 2 1/2" Screws
 x 3 total

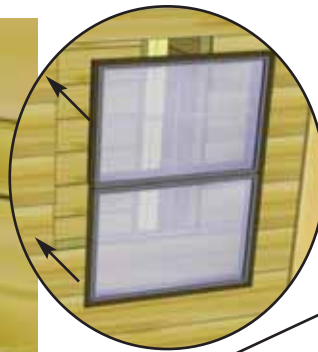
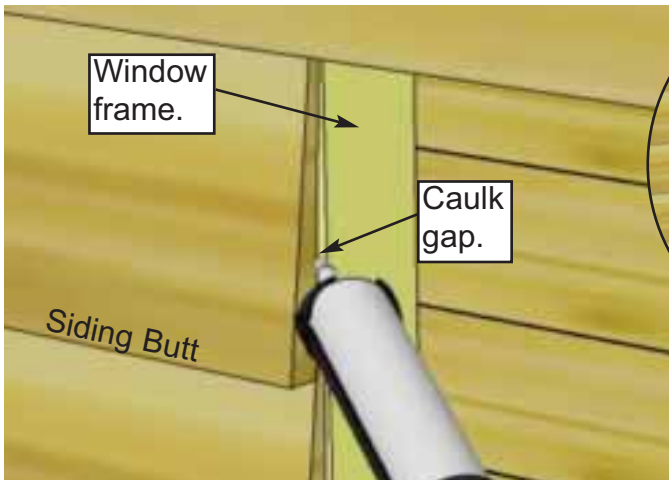

Screw insert into bottom (thick) part of siding.



93. To reduce possible water from penetrating into the window cavity, caulk gap on both sides of window opening prior to installing **Window Insert**. Position insert in cavity and screw with **6 - 1 1/4" Screws**. On sides, make sure to screw insert into the thick butt of the siding only.

Parts (Step 93)
Window Insert x 3
Hardware (Step 93)
S2 - 1 1/4" Screws
 x 36 total

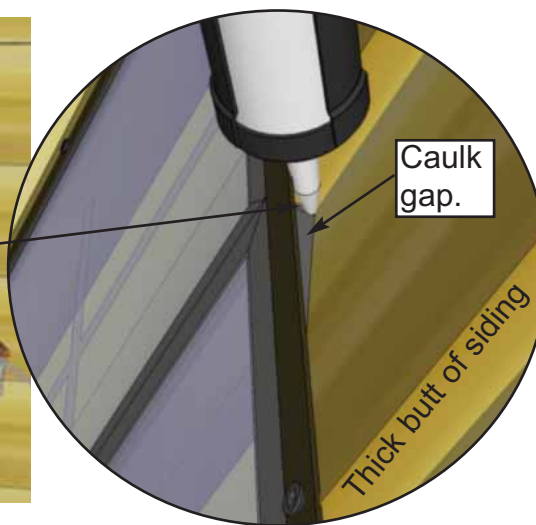

94. Once Insert is attached, caulk the "triangular gap" between the Insert's outside flange and the siding. Also put a bead of caulking horizontally at top of window where the flange and siding meet. This additional caulking will also will reduce the chances of moisture entering into your shed.

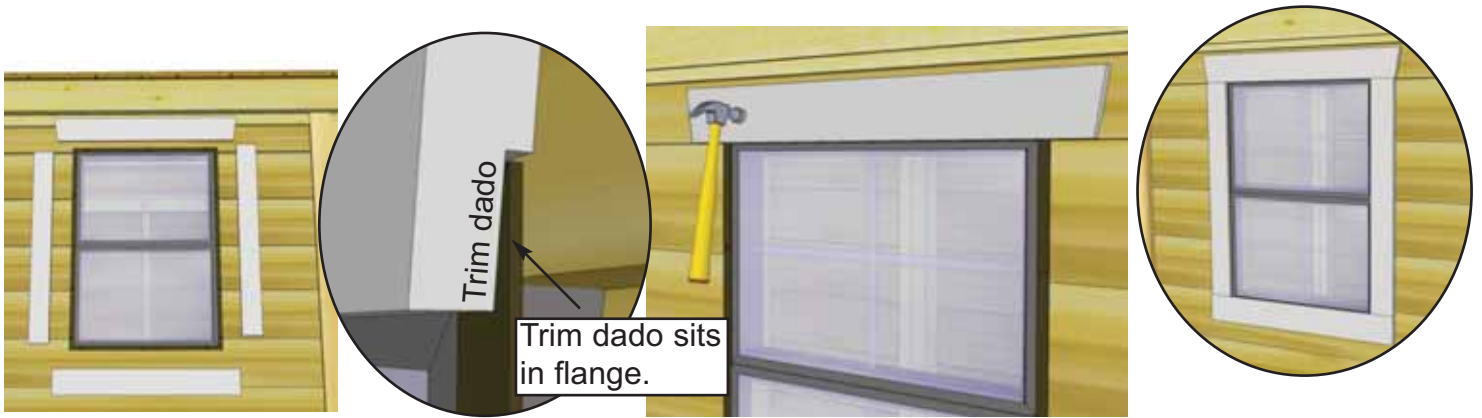

95. Position **Window Trim** around window doing a dry run first and attach with **4 - 1 1/2" Finishing Nails** per piece. Window trim has a small dado on reverse face. Outside flange of window will roughly sit in the dado to give a better fit.

<p><u>Parts (Step 95)</u> Window Trim Package x 3 (Top - 24 1/16" Long - <i>Angle Cut Ends</i>) x 1 (Sides & Bottom - 23" Long) x 3</p>	<p><u>Hardware (Steps 95)</u> N1 - 1 1/2" Finishing Nails x 48 total</p>
---	---

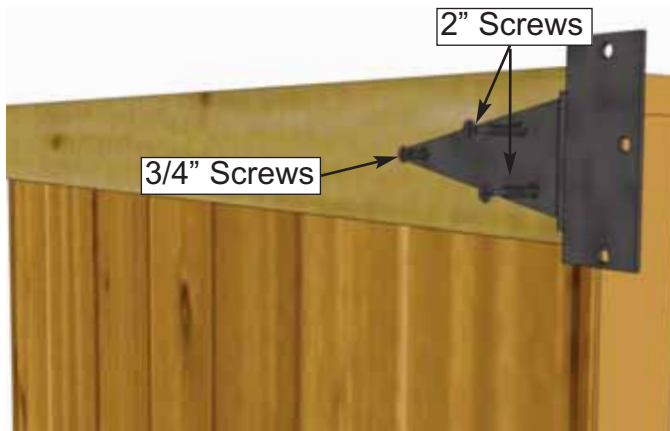
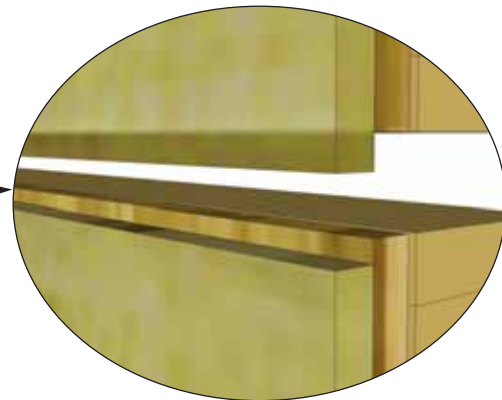
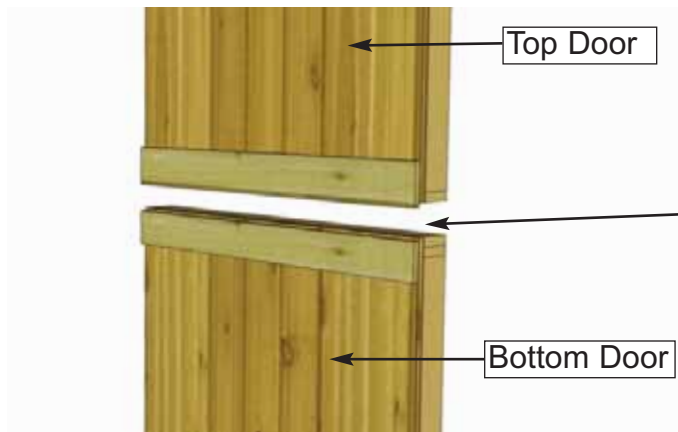

96. Attach Door hinges to Top and Bottom **Dutch Door** sections. Top Door has trim overhanging door at bottom while bottom door has trim recessed slightly. Hinges should be centered on door trim with barrel nudged to end of trim. Use **2" & 3/4" screws** as above.

<p><u>Parts (Step 96)</u> Dutch Door (Top) x 1 (Bottom) x 1</p>	<p><u>Hardware (Step 96)</u> SB2 - 2" Black Screws x 8 total SB1 - 3/4" Black Screws x 4 total Y1 - Black T Hinge x 4 total</p>
--	--

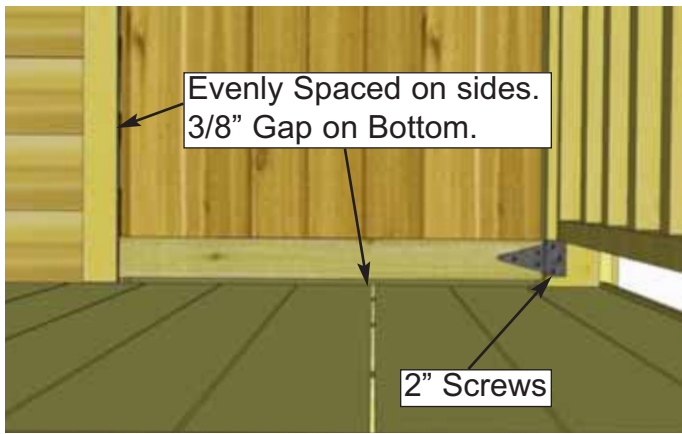

97. Place **Bottom Dutch Door** panel into position. Gap 3/8" on bottom, evenly space on sides, and attach hinge to doorway seam trim with **3 - 2" Black Headed Screws**. Use shim to help keep the door evenly spaced on bottom. One of the **Shim Shingles** can be used.

Parts (Step 97)
Dutch Door (bottom) x 1
Shim Shingles

Hardware (Step 97)
SB2 - 2" Black Screws
 x 12 total

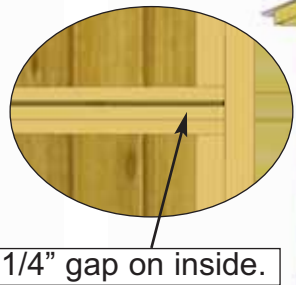
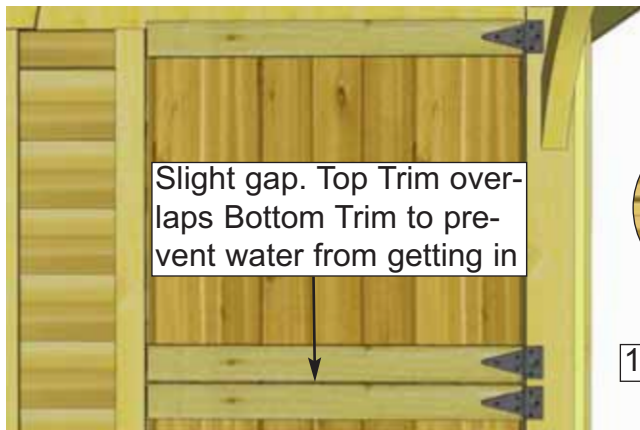

98. Place the **Top Dutch Door** panel into place and gap top and bottom trims on the outside about 1/8" apart/ On the inside, horizontal door frames should be about 1/4" apart. Use a shim once agin to help you. Attach hinges to trim with **2" Black Headed Screws** provided.

Parts (Step 98)
Dutch Door (Top) x 1
Shim Shingles

Hardware (Step 98)
SB2 - 2" Black Screws
 x 12 total



99. Attach **Door Handle, Exterior Drop Latch and Interior Barrel Bolt** to door. **Handle** is positioned on top door, **Drop Latch** on bottom door, and **Interior Barrel Bolt** (silver) on top door stud. Attach **Black Drop Latch** as illustrated above with **4 - 3/4" Black Screws**. Note how female part of Drop Latch is positioned higher than male part. Do a dry run first to position **Drop Latch** correctly. Important: Drill pilot holes with 1/8" drill bit prior to securing to prevent wood from splitting.

Hardware (Step 99)
SB1 - 3/4" Black Screws
 x 16 total
Y3 - Black Handle
 x1
Y4 - Black Drop Latchx1
Y5 - Silver Barrel Bolt
 x1



100. Attach **Horizontal Door Stop** and **Vertical Door Stops** to door jamb and wall framing. Use **4 - 2" screws** to secure **Horizontal Stop**, and **6 - 2" screws** per **Vertical Stop**. Door Stops should overhang the door by approximately 1/2". Start with the Horizontal Stop first.

Parts (Steps 100)
Horizontal Door Stop
 (1/2" x 2 1/2" x 35 1/4") x 1
Vertical Door Stop
 (1/2" x 2 1/2" x 72") x 2

Hardware (Steps 100)
S3 - 2" Screws
 x 16 total

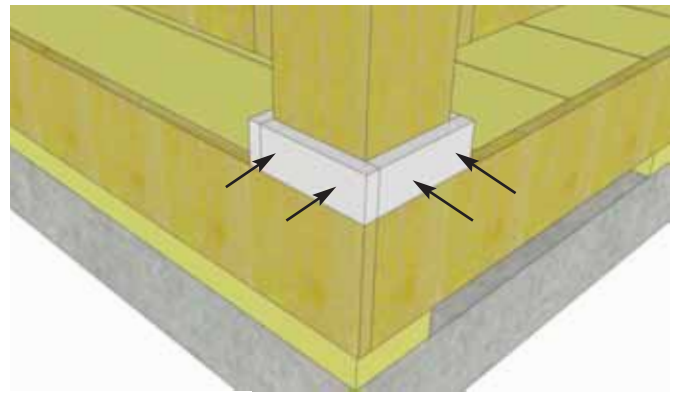
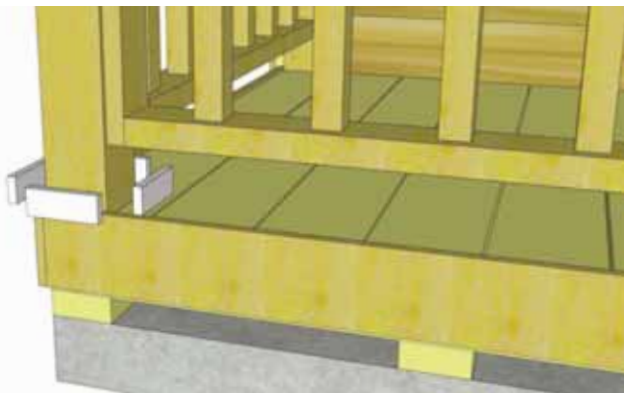

101. Attach **Post Base Trims** to bottom of porch posts. Attach with **2 - 1 1/2" Finishing Nails**.

Parts (Steps 101)

Post Base Trims

(1/2" x 1 1/2" x 4") x 12

Hardware (Steps 101)

N1 - 1 1/2" Finishing Nails

x 24 total

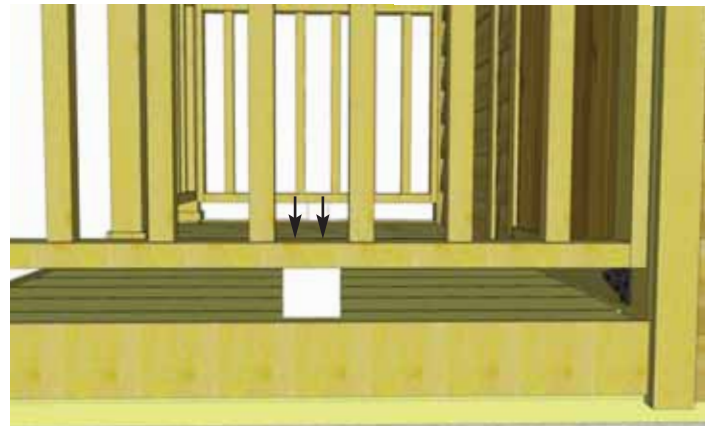
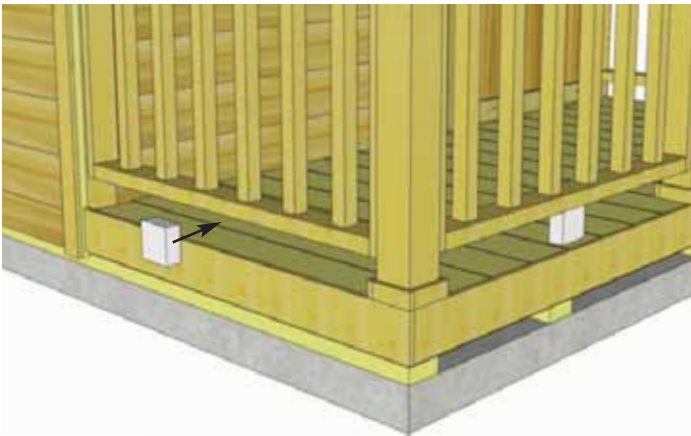

102. Place **Handrail Support Blocks** beneath Handrails, centered side-to-side and front-to-back. Attach each block with **2 - 2 1/2" screws** through the Handrail bottom.

Parts (Steps 102)

Handrail Support Blocks

(1 1/2" x 3 1/2" x 3 1/2") x 3

Hardware (Steps 102)

S1 - 2 1/2" Screws

x 6 total



103. Assemble **Flower Box Kits** with Assembly Instructions included on Page 55. Position completed Flower Box below bottom of window trim and secure with **2 - 2 1/2" screws**. Screw from inside of box into the center wall stud. Attach second screw 2" underneath first screw and once again into the wall stud. Install Flower Box Kits underneath each window/double-window..

Hardware (Step 103)

S1 - 2 1/2" Screws

x 6 total

Parts (Step 103)

Flower Box Kits

x 3

Outdoor Living Today Flower Box Assembly Instructions

Parts Lists:

A - Base, Rear & Front Box Frames	(3pcs)	3/4" x 5 1/2" x 23"
B - End Cap Frames	(2pcs)	3/4" x 5 1/2" x 7" / 8"
C - Front Trim	(1 pc)	3/4" x 1 1/2" x 26"
D - Side Trims	(2 pc)	3/4" x 1 1/2" x 8 3/4"
E - Brackets	(2 pc)	1 1/2" x 5 1/2" x 5 1/2"
F - 1 1/4" Screws		
G - 1 1/4" Nails		

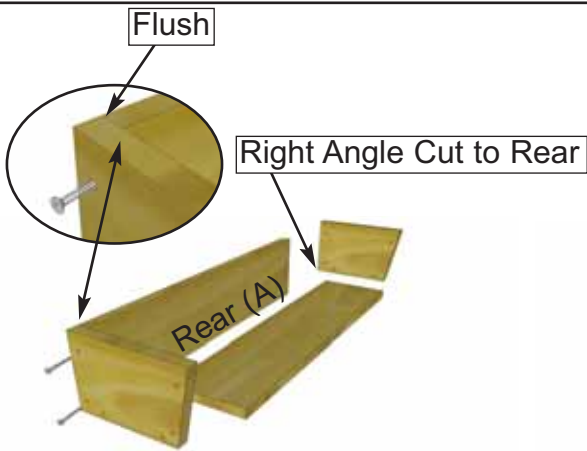
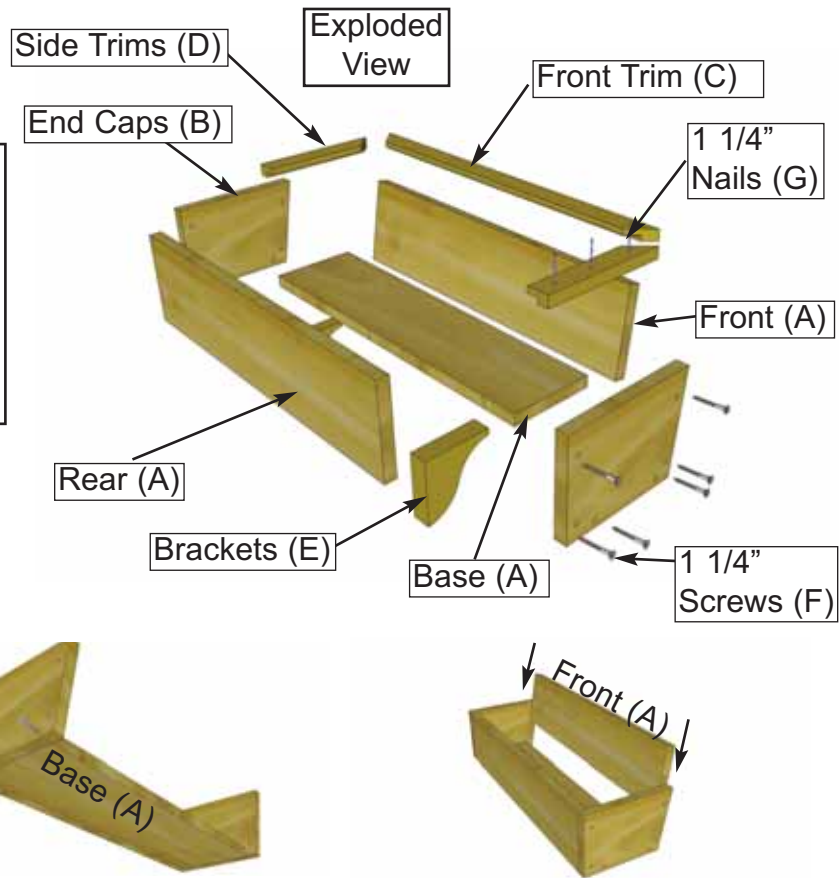

1. On a table position Rear Box and End Cap Frames together so flush at top. Fasten together with 2 - 1 1/4" screws. Place Base Frame tight against Rear and End Cap and flush at bottom. Secure with 2 - 1 1/4" screws. Complete attachment of remaining End Cap Frame. Slide Front Frame between End Caps.

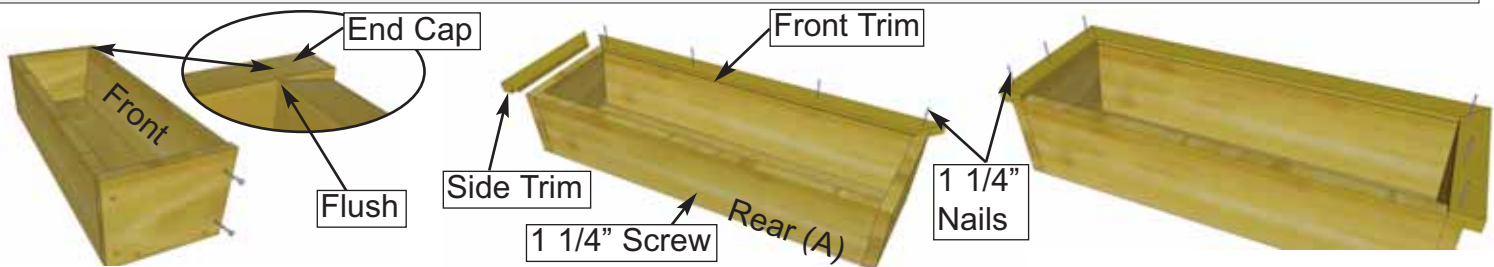

2. Position Front Frame Piece flush with End Cap. Attach both ends with 2 - 1 1/4" screws. Pilot hole Rear Box Frame near bottom center and secure to Base edge with 1 - 1 1/4" screw. Evenly position Front Trim (mitre cut on end and dado cut on inside bottom) tight against front frame and nail down with 4 - 1 1/4" nails. Position Side Trims as per Front and secure with 3 - 1 1/4" nails per side.

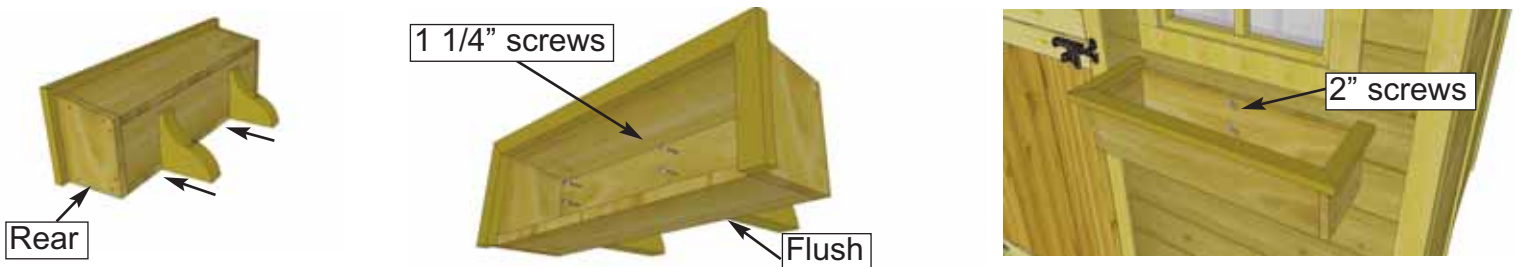

3. On a flat surface, flip Flower Box on it's rear face. Evenly space Brackets and secure through Base Frame and into the Brackets with 2 - 1 1/4" screws per Bracket. Position completed Flower Box beneath window trim and screw from inside of box into the center wall stud with 2 - 2" screws. (2" screws supplied with Base Kit.)



Congratulations on building your 8x12 Santa Rosa Garden Shed!

Note: Our Sheds are shipped as unfinished products. If exposed to the elements, the western red cedar lumber will weather to a silvery-gray color. If you prefer to keep the cedar lumber looking closer to the original color, we suggest that you treat the wood with a good oil base wood stain. You may also wish to paint your new shed rather than stain it. In both cases we recommend that you consult with a paint and stain dealer in your area for their recommendations.



We hope your experience constructing our building has been both positive and rewarding.

We value your feedback and would like to hear back from you on how well we are doing in the following areas:

1. Customer Service
2. On Time Shipping
3. Motor Freight Delivery
4. Quality of Materials
5. Assembly Manual
6. Overall Satisfaction.

Please call, write or email us at:

Canadian Address
9393 287th Street
Maple Ridge, British Columbia
Canada V2W 1L1

United States Address
P.O. Box 96
Sumas, Washington
USA 98295



The materials contained in this Assembly Manual may be downloaded or copied provided that ALL copies retain the copyright and any other proprietary notices contained on the materials. No material may be modified, edited or taken out of context such that its use creates a false or misleading statement or impression as to the positions, statements or actions.