

6x4 MAXIMIZER WITH SINGLE DOOR AND CEDAR ROOF ASSEMBLY MANUAL

Version #1.0
June 5, 2023

Stock Code:
MAX64-S-CEDAR-AK

Thank you for purchasing a 6x4 Maximizer. Please take the time to identify all the parts prior to assembly.



Important Information:

- It is the sole responsibility of the customer to check with your local municipal or county by-laws before ordering this product to confirm it complies with building codes in your area.
- If the product is elevated, any structural and building code requirements are solely the customer's responsibility, and should be abided by.
- Snow load ratings vary by geographical location. If heavy or wet snowfall occurs, it is advisable to sweep snow off roof frequently.
- In areas with high or gusty wind conditions, it is advisable to install the structure securely to the ground.
- Have a regular maintenance plan to ensure screws, doors, windows and parts are tightly affixed.
- All structures purchased from Outdoor Living Today are covered for a period of one year for defects in manufacturing and workmanship. Costs incurred for customer installations are not included.
- Failure to use supplied parts included in this kit could result in poor product performance and may void your warranty. Please contact Outdoor Living Today's Customer Toll Free Line if you plan to deviate from our written instructions.

Customer agrees to hold Outdoor Living Today and any Authorized Dealers free of any liability for improper installation, maintenance and repair.

In the event of a missing or broken piece, simply call the Outdoor Living Today Customer Support Line @ 1-888-658-1658 within 30 days of the delivery of your purchase. It is our commitment to you to courier replacement parts, free of charge, within 10 business days of this notification. Replacement parts will not be provided free of charge after the 30 day grace period.

What to do before my Shed arrives?



- Become familiar with this assembly manual and determine if you can complete the project yourself or will require a professional contractor.



- One helper is recommended to assist in constructing your chalet. It generally takes two people about one day to assemble a shed. If you're hiring a contractor, their rate should be in line with that duration of work.



- Clear the construction area and ensure a clear pathway for delivery when the freight company arrives. Remove all debris: roots, grass, rocks, etc.



- Excavate the site. Contact your local utilities company to ensure there are no gas or electric lines buried in the area before digging.

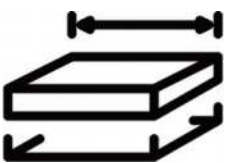

- Decide on the type of foundation you will be using:
 - Concrete slab, or
 - 4-6 inches of crushed gravel with paver stones or 4x4 stringers.

You can find the footprint for your shed on Page 3 of your Assembly Manual.



- If doing the assembly yourself, have all the necessary tools ready to go and in working condition. A list of required tools can be found after the parts list.

Foundation Types for 6x4 Garden Shed

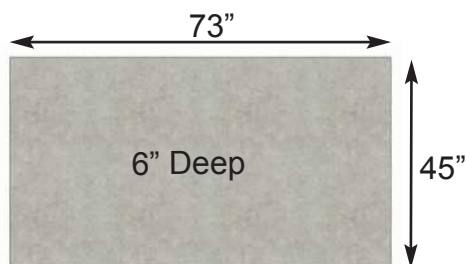

Concrete Foundation

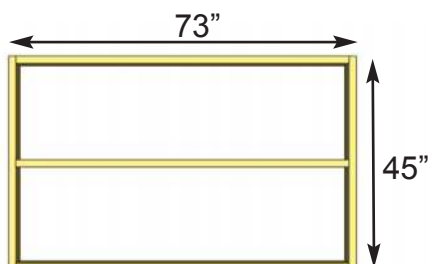

Floor Frame



Completed Foundation

Concrete Slab Foundation:

- Slab must be at least the same size as assembled floor frame (45" x 73") or larger.
- 6" Deep foundation.
- 0.5 Cubic Yards of concrete required.
- A concrete slab will have the longest durability out of your foundation options.

Once level, a concrete slab is the easiest surface to build on.

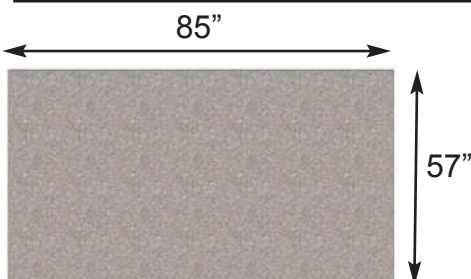

Gravel Foundation

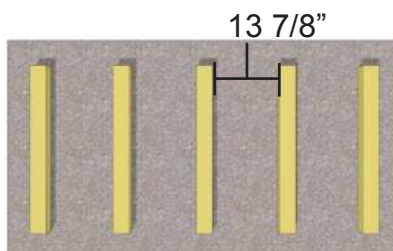

5 - 4"x4"x44 3/4"

Gravel Foundation with treated stringers

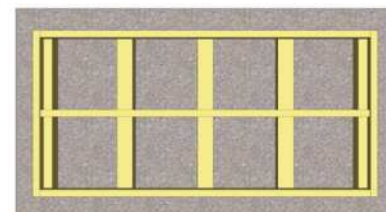

Completed Foundation

Gravel with 4x4 Pressure Treated Stringers:

- Excavate at least 6" deep, and 6" wider than floor frame on each side.
- 0.6 Cubic Yards of gravel required, approximately 6 wheelbarrows.
- 5 - 4x4 Pressure Treated Stringers 44 3/4" long required.
- Evenly spaced, with one at each end of floor frame.

Saves money on materials, easy to level and work with.

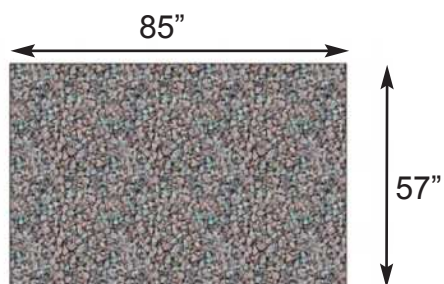

Gravel Foundation



Gravel Foundation with Patio Pavers

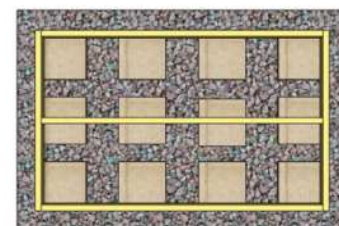

Completed Foundation

Gravel with Patio Paver Stones:

- Excavate at least 6" deep, and 6" wider than floor frame on each side.
- 0.6 Cubic Yards of gravel required, approximately 6 wheelbarrows.
- 12 patio pavers (8" x 8" or larger).
- Center patio paver stones underneath floor runners and underneath seams in floor joists.

Patio paver stones are widely available from most landscape stores.

**Thank you for purchasing our 6x4 Maximizer with Cedar Roof.
Please take the time to identify all the parts prior to assembly.**

Parts List	Steps	D. - Trim / Misc. Section Cont.	Steps
A. - Floor Section Floors 1 - Floor Section - 45" x 73" 1 - Mid Floor Joist - 1 1/2" x 2 1/2" x 70"	1	Outer Wall Trim and Fascia 4 - Wide Vertical Trims - 1/2" x 3 1/2" x 76" 1 - Left Side Door Trim - 1" x 4 1/8" x 76" 4 - Side Wall Corner Trims - 1/2" x 2 1/2" x 78 1/2" 2 - Side Wall Trims - 1/2" x 2 1/2" x 74 3/4" 1 - Horizontal Gable Trim - Right - 1/2" x 3" x 42 1/4" 1 - Horizontal Gable Trim - Left - 1/2" x 3" x 41 1/8" 1 - Rear Horizontal Trim - 1/2" x 2 1/2" x 67 1/4" 1 - Rear Wall Center Trim - 1/2" x 2 1/2" x 73 1/2" 1 - Front Horizontal Trim - 1/2" x 2 1/2" x 31 5/8" 4 - Front/Rear Fascia - 3/4" x 3 1/2" x 39 5/8" 2 - Side Fascia - 3/4" x 3 1/2" x 27 1/4" - Angle Cut Ends 2 - Pentagon Detail Plates - 1/2" x 5" x 8" 2 - Fascia Detail Plates - 1/2" x 3 1/2" x 8" - Angle Cut Ends	53 - 65
B. - Wall Section Main Wall Panels 3 - Front/Rear Walls - 35" x 72 3/4" 4 - Side Walls - 22 1/2" x 72 3/4" 3 - Top Wall Plates - 1 1/2" x 1 1/2" x 35" 4 - Top Wall Plates - 1 1/2" x 1 1/2" x 22 1/2" Header/Gables 2 - Door Jambs - 1 1/2" x 1 1/2" x 72 3/4" 2 - Front/Rear Header - 1 1/2" x 1 1/2" x 73" 2 - Side Plates - 1 1/2" x 1 1/2" x 42" 2 - Front/Rear Top Plates - 3/4" x 1 1/2" x 73" - Angle Cut 2 - Gables - 11 3/4" x 42"	2 - 13 15 - 24	Door System 1 - Solid Door - 31 1/2" x 72" Miscellaneous Shelves 4 - Storage Shelf Supports - 3/4" x 2 1/2" x 35" 2 - Storage Shelves - 11 1/2" x 41 7/8" ** Plus 2 Cedar Shingle Shims - discard after shimming doors	66 - 69 70 - 71
C. - Rafters and Roof Section Roof 2 - Cedar Shingle Roof Panels - 45" x 53" 4 - Roof Nailing Strips - 3/4" x 1" X 24 12" 8 - Rafters - 1 1/2" x 2 1/2" x 26 1/2" 4 - Soffits - 1/2" x 2 1/2" x 36 1/2" 2 - Roof Ridge Boards - 3/4" x 3 1/2" X 73" 12 - Roof Ridge Caps - 16" 1 - Roof Ridge Caps - 10" 2 -	26 - 46	<p><u>Note:</u> We recommend you drill a 1/8" pilot hole for each screw to avoid splitting wood. The hole depth should be equal to 3/4 the length of screw.</p>	
D. - Trim / Misc. Section Lower Skirting 1 - Doorway Skirting - 1/2" x 2 1/2" x 33 1/4" 3 - Front/ Rear Skirting - 1/2" x 2 1/2" x 35 3/4" 4 - Side Skirting - 1/2" x 2 1/2" x 21 3/4" Filler Trim 6 - Front/Rear Filler Trims - 5/8" x 1 1/2" x 30" 1 - Doorway Filler Strip - 5/8" x 1 1/2" x 71" 2 - Side Gable Filler Strips - 5/8" x 1 1/2" x 42"	48 49 - 52		

**Note: Trim and Skirting pieces are graded with the best face being rough sawn.
Rough sawn cedar is much easier to paint and stain.**

6x4 MAXIMIZER - CEDAR ROOF

Hardware Kit (Provided)

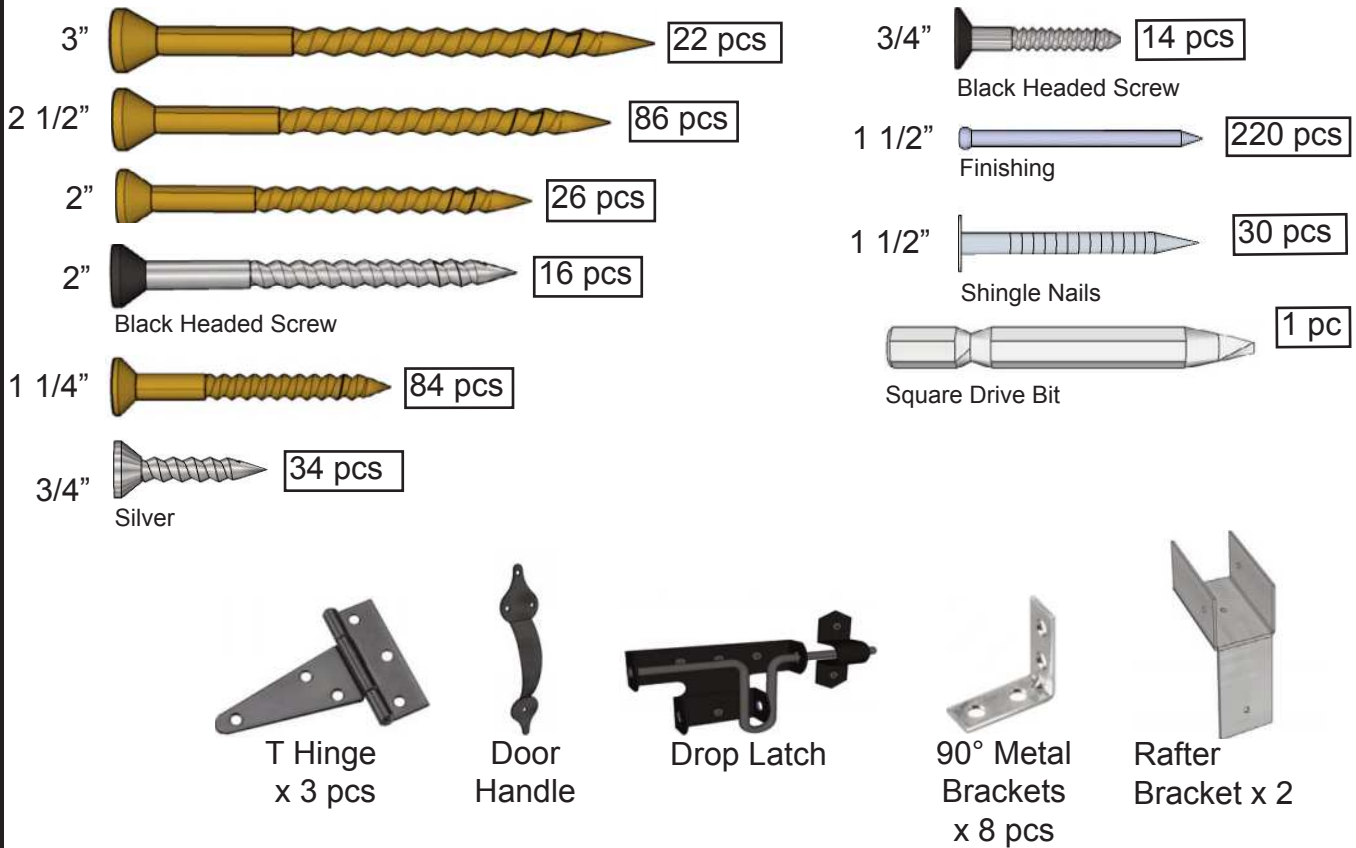

Tools Required (Not Provided)



Safety Equipment Required (Not Provided)



Regular Maintenance & Tips to prolong the life of your shed.

Before/During Assembly:

- 1.) Paint each face and edge of your plywood floor with a latex exterior paint.
- 2.) Caulk wall seams if gaps appear.
- 3.) Caulk around window framing.
- 4.) Caulk perimeter between floor plywood and bottom wall plate.
- 5.) Caulk channels in lap siding at the top of your door above the trim, just a drop in each channel.
- 6.) Caulk edge of door threshold.
- 7.) Optional: Install a Sill Gasket between floor runners and foundation.
- 8.) Optional: Install an 8" strip of roofing paper below Cedar Ridge Caps for Cedar Roof Sheds.

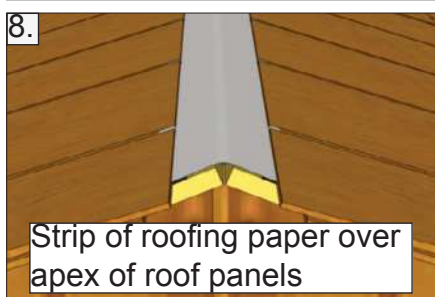
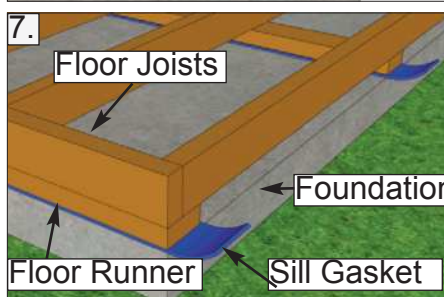
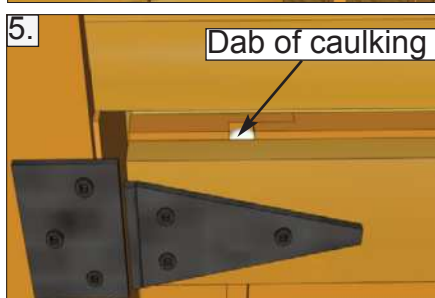
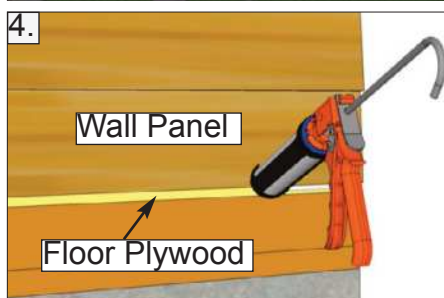
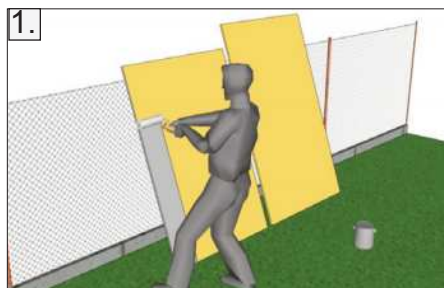

Routine Maintenance:

- Routinely check all fasteners are tight (ex. Door Hinges, Nails)
- Brush off dirt from walls.
- Brush off snow from roof regularly.
- Routinely remove needles and leaves from cedar roof.

Painting/Staining

- Your cedar shed, if left untreated, will weather to a silvery grey colour.
- Painting or staining your structure is highly recommended and will prolong the life of your shed.
- You do not need to wait to paint or stain your shed, the wood in your kit has been dried and can be stained or painted immediately.
- Consult your local paint store for the best paint or stain for cedar.
- Optional: stain the inside of your shed. (Note: this will remove the fresh cedar smell.)

A. Floor Section

Exploded view of all parts necessary to complete the Wall Section. Identify all parts prior to starting.

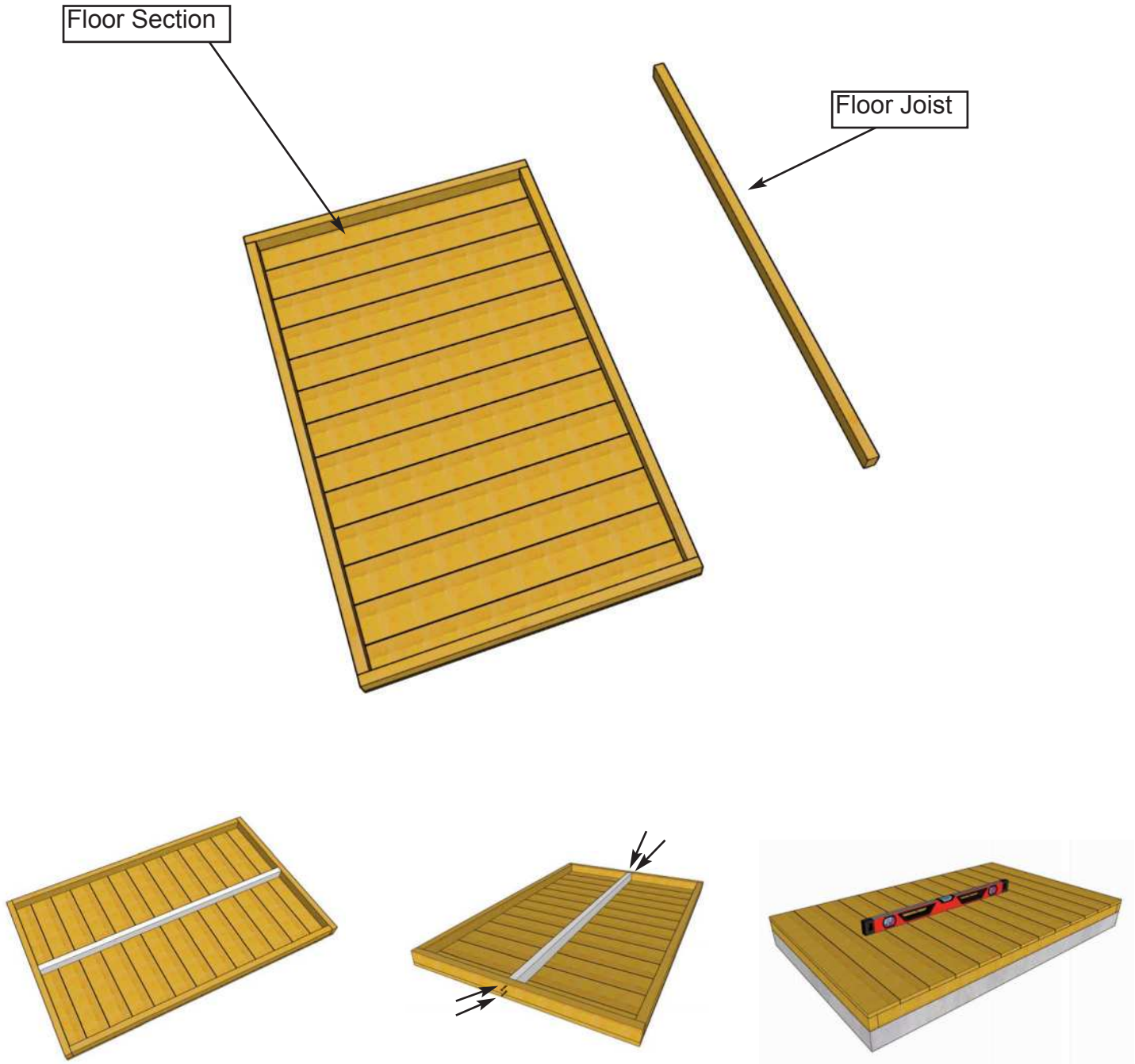

1. Locate **Floor Joist** and position at center of **Floor Section** and flush with framing as illustrated above. Attach with **2 - 2 1/2" Brown Screws** per end. Flip over and lay Floor Section on a level foundation only. Patio Stones or a Concrete Slab both make excellent foundations. (See Page 3 for more information on foundations). Use a level to confirm and shim Floor Joist as required.

<p><u>Parts</u> Floor Joist (1 1/2" x 2 1/2" x 70") x 1 Floor Section (45" x 73") x 1</p>
<p><u>Hardware</u> 2 1/2" Brown Screws x 4 total</p>

B. Wall Section

Exploded view of all parts necessary to complete the Wall Section. Identify all parts prior to starting.

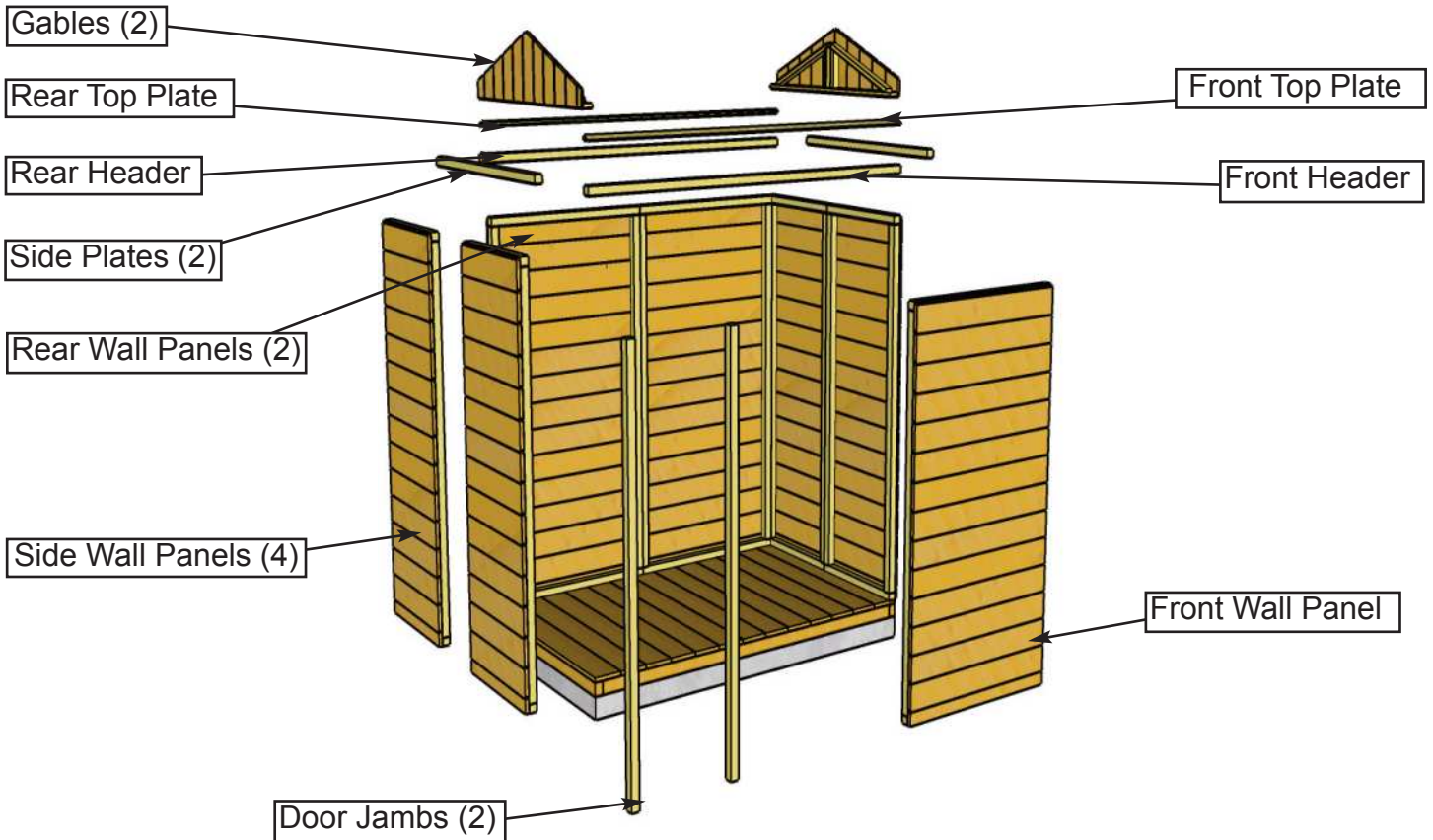

Due to packaging constraints, top wall plates must be attached prior to erecting walls.

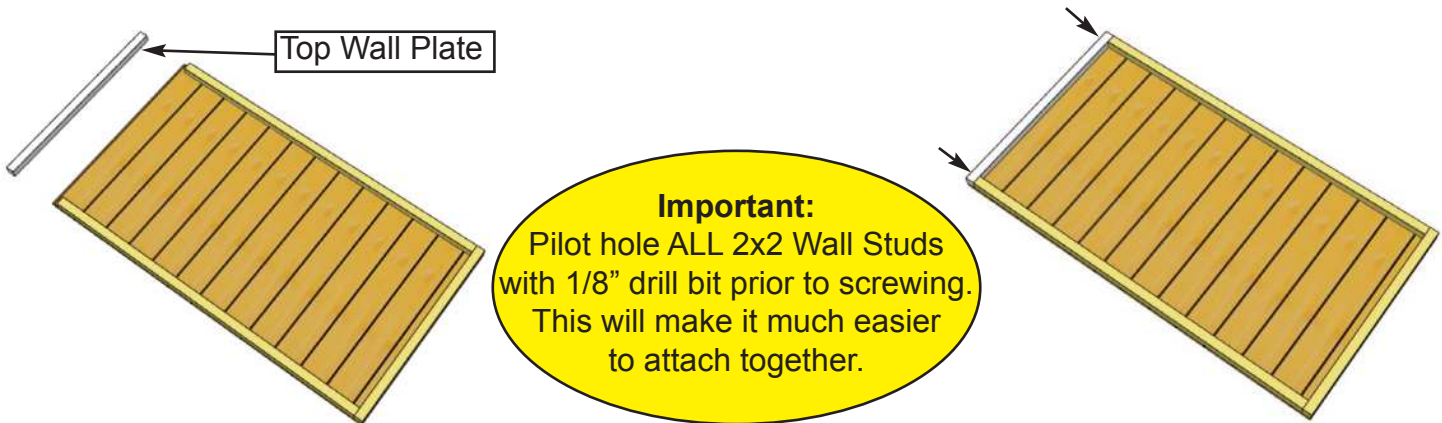

2. For each **Front/Rear and Side Wall Panel**, carefully lay Panel face down. Position and attach a **Top Wall Plate** to top of wall studs of each Wall Panel with **2 - 2 1/2" Brown Screws**. Position so Plates are flush with framing.

Parts	Parts	Hardware
Front/Rear Wall Panels (35" x 72 3/4") x 3 Top Wall Plates (1 1/2" x 1 1/2" x 35") x 3	Side Wall Panels (22 1/2" x 72 3/4") x 4 Top Wall Plates (1 1/2" x 1 1/2" x 22 1/2") x 4	2 1/2" Brown Screws x 14 total

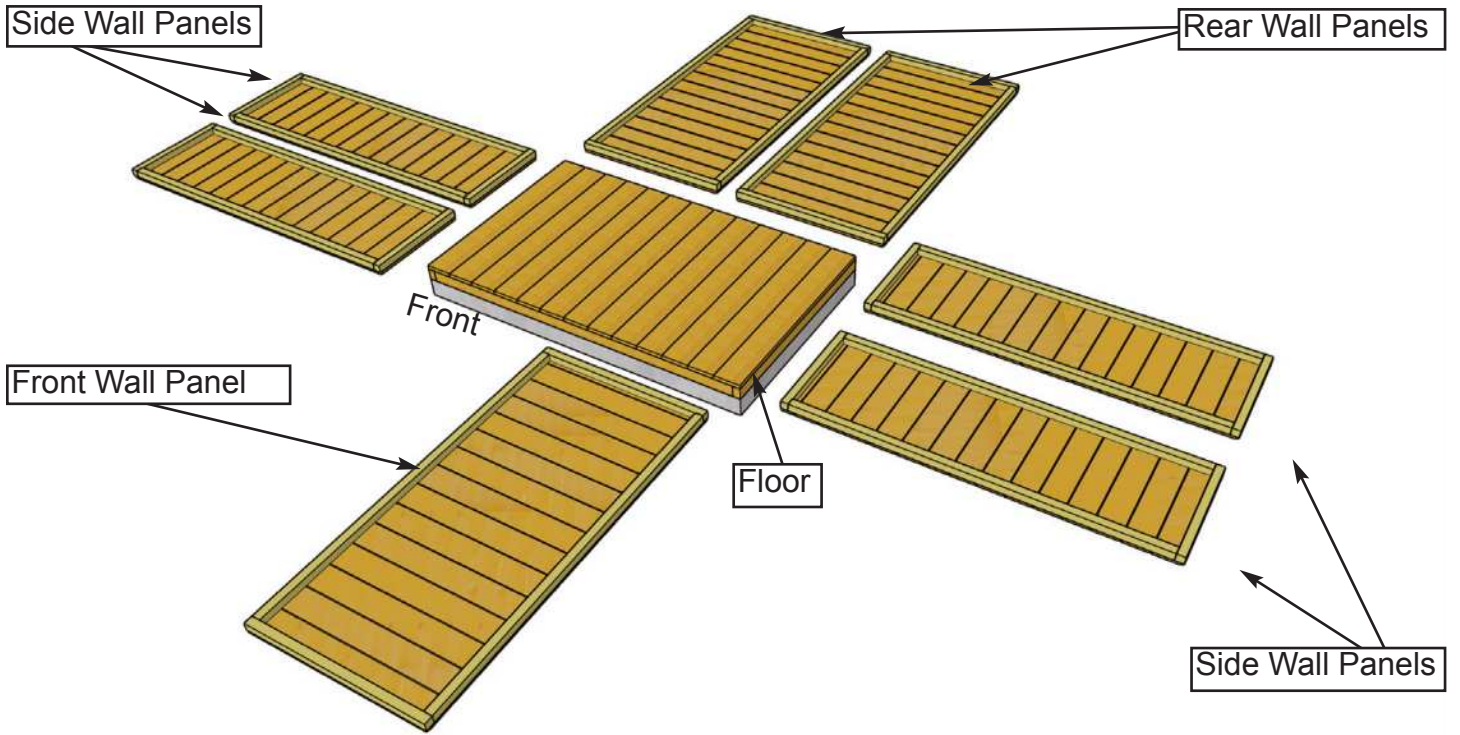

3. With Wall Plates properly attached, orientate completed Walls around the Floor. Be sure to leave room to work.

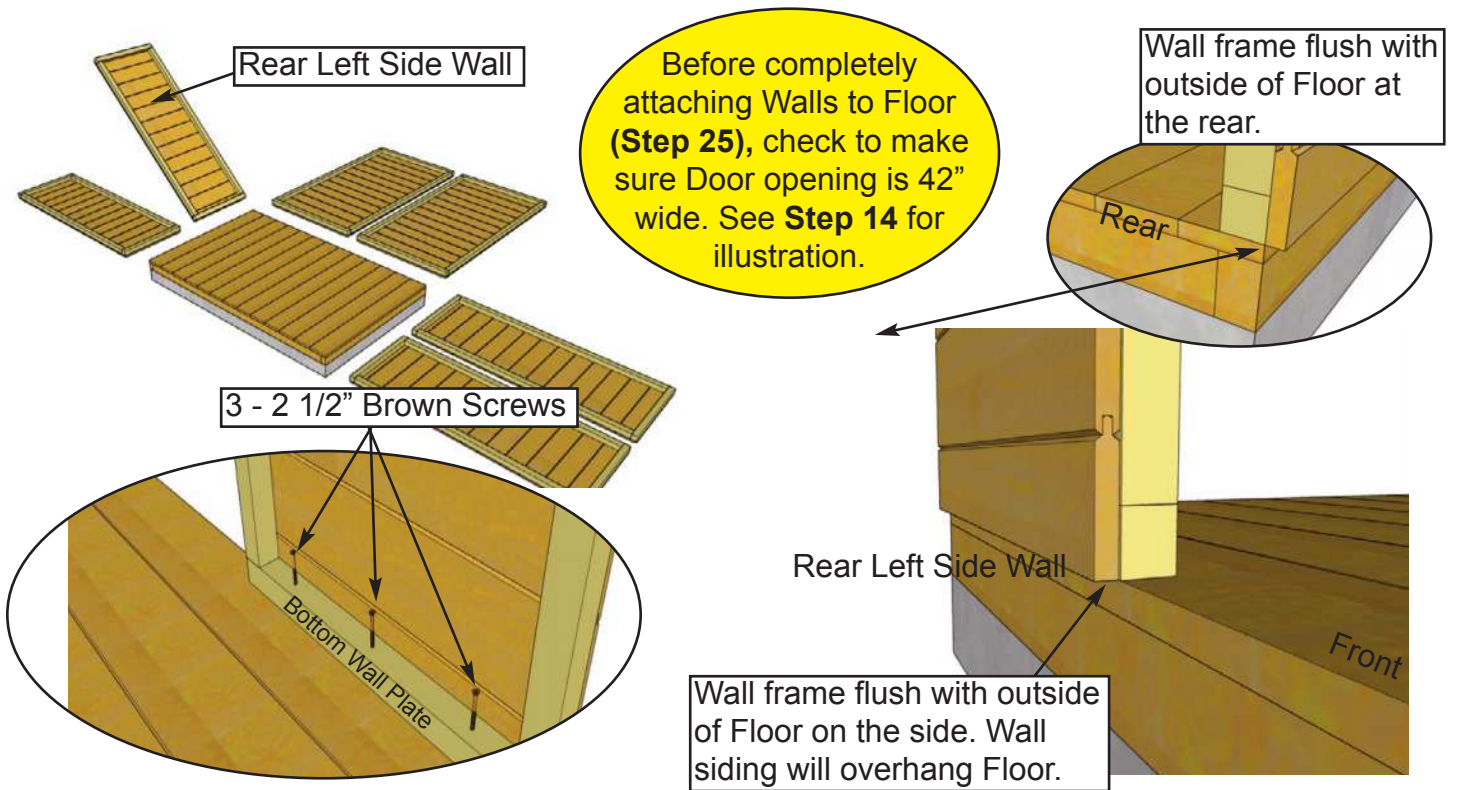

4. Starting with **Rear Left Side Wall**, lift up and position so framing is flush with Floor at the rear of shed. Make sure Wall frame is flush with outside of Floor on the side. When Wall is positioned correctly, secure Bottom Wall Plate to Floor with **3 - 2 1/2" Brown Screws**.

Hardware (Steps 4 - 12)
2 1/2" Brown Screws
 x 3 total
3" Brown Screws
 x 18 total

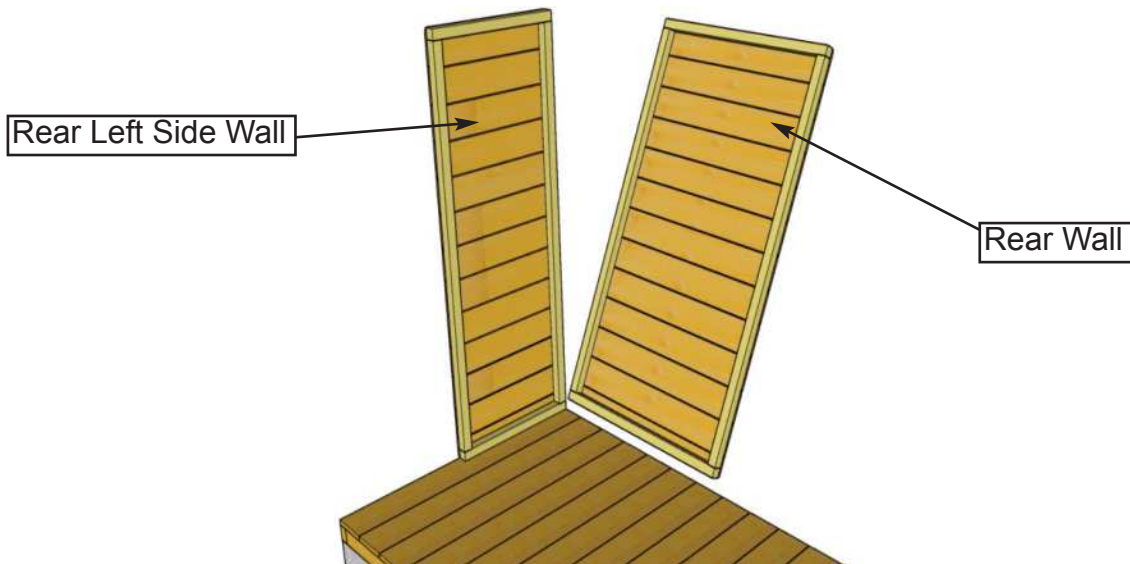

5. With your helper holding the Side Wall Panel, position a **Rear Wall Panel** in rear corner. **Important: Align Wall Framing Flush with Floor Framing.**

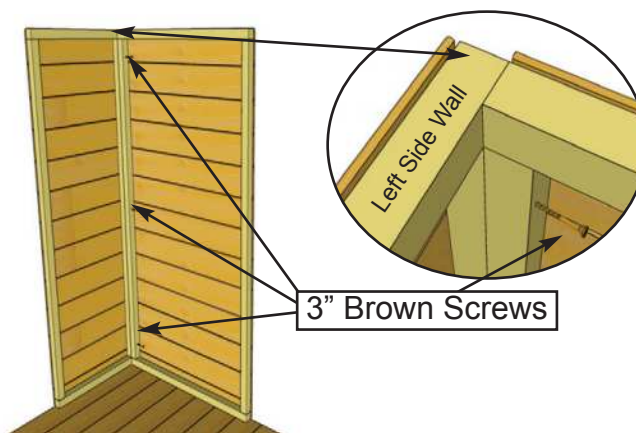
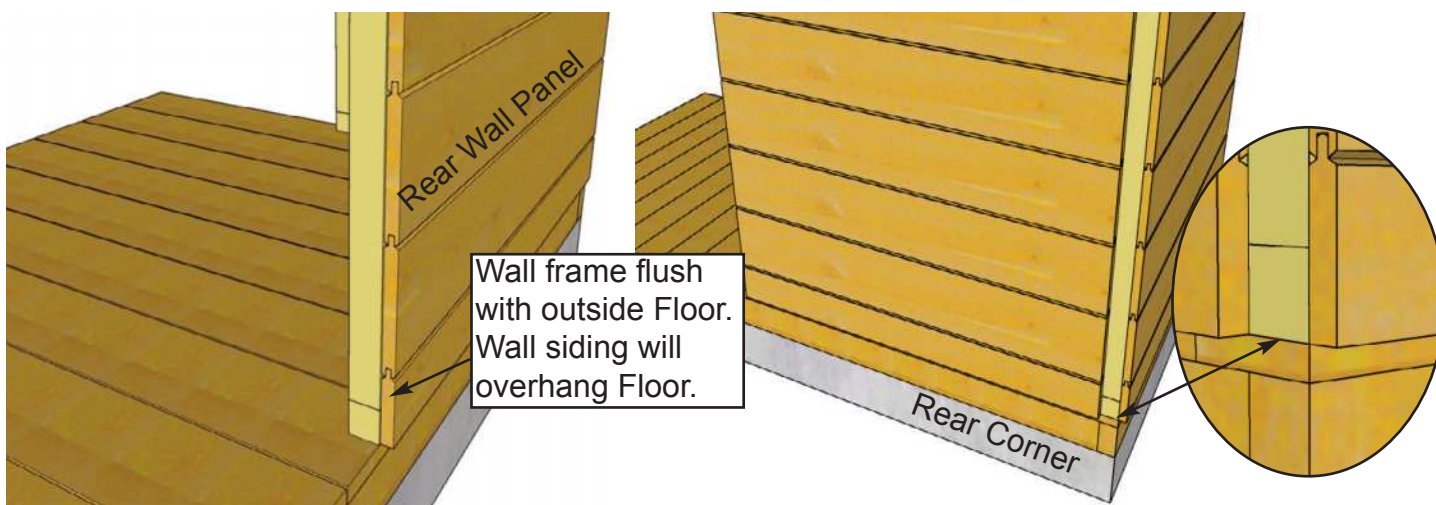

6. When Side and Rear Walls are aligned in corner correctly, Wall framings will be flush. Attach Wall framings together with **3 - 3" Brown Screws**.

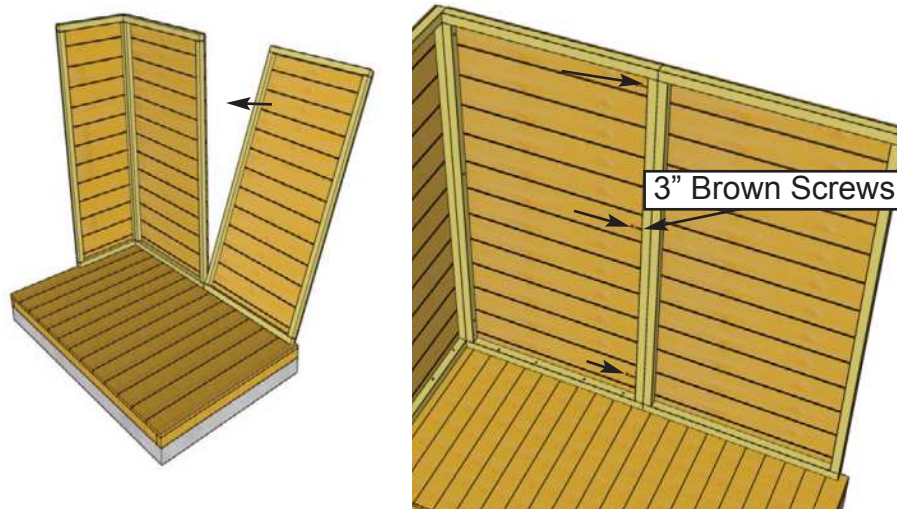

7. Position second **Rear Wall Panel** on Floor as per **Step 6**. Attach Wall frames together at top, middle and bottom with **3 - 3" Brown Screws**. **Important: Confirm Siding on Rear Wall Panels are aligned.**

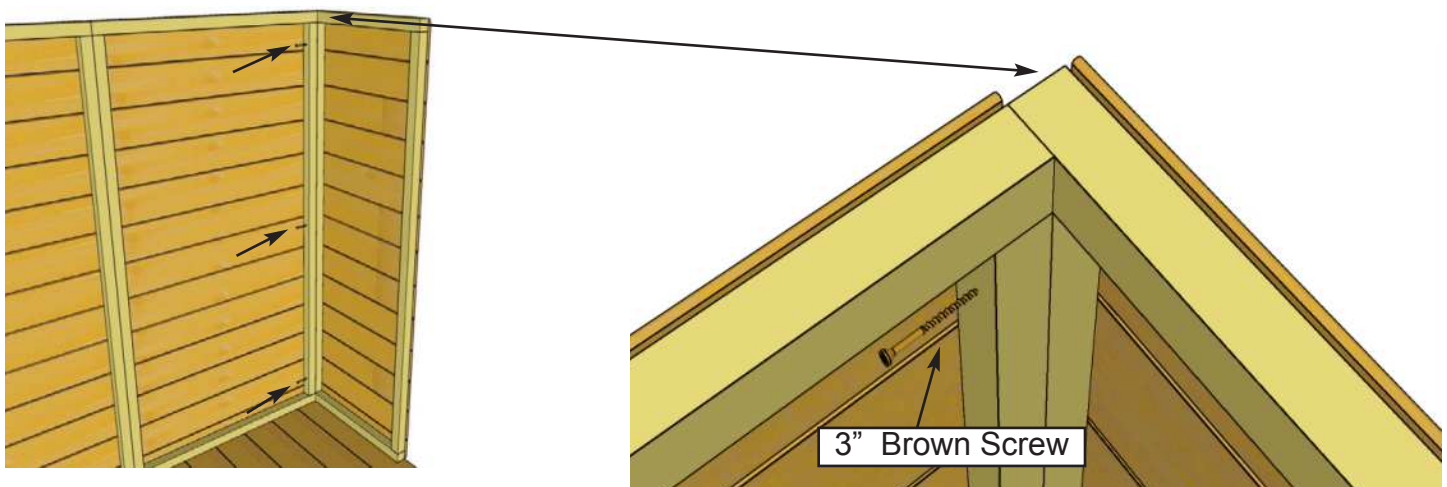
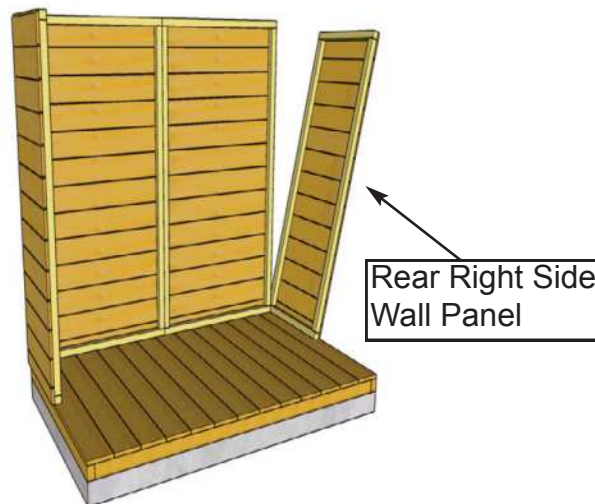

8. In the corner, align and attach Right Side Wall framing to Rear Wall framing with **3 - 3" Brown Screws** as per **Step 6**.



9. Position second **Left Side Wall Panel** on Floor. Attach Wall frames together at top, middle and bottom with **3 - 3" Brown Screws**. **Important: Confirm Siding on Side Wall Panels are aligned.**

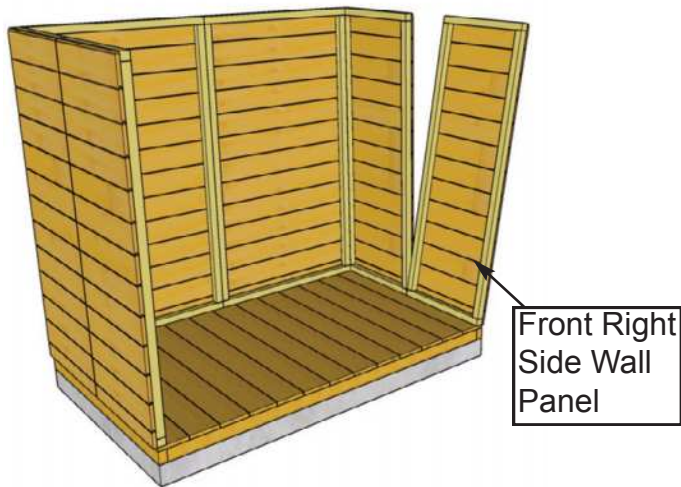

10. Position second **Right Side Wall** on the floor. Attach Wall frames together with **3 - 3" Brown Screws**.

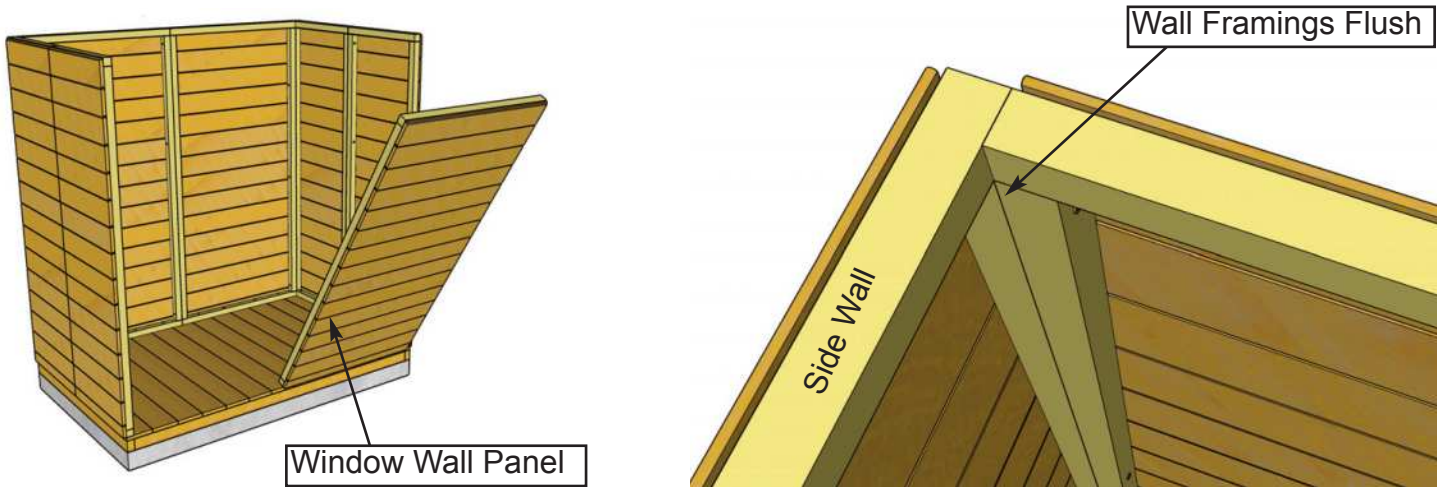

11. Locate **Front Wall Panel** and position Wall framing flush with Side Wall framing in corner.
Important: Make sure Window Wall is positioned right side up.

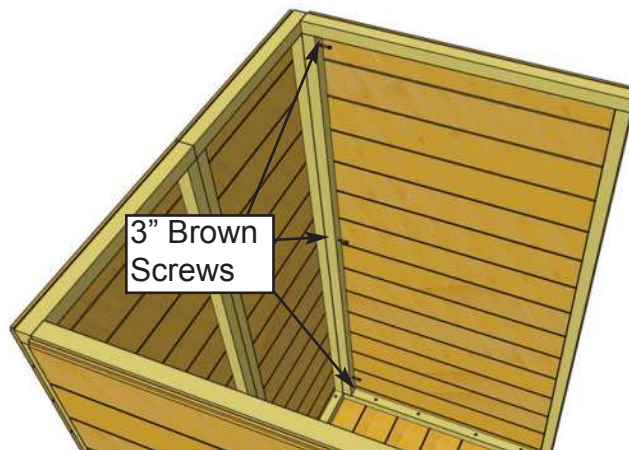

12. Align Wall framing flush with outside of Floor framing. When correctly positioned, secure vertical Wall framings together at top, middle and bottom with **3 - 3\"/>**

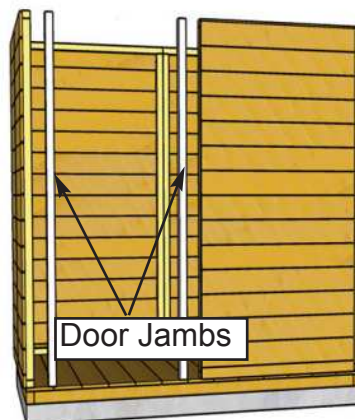

13. Locate **Door Jambs** and place on either side of door opening.

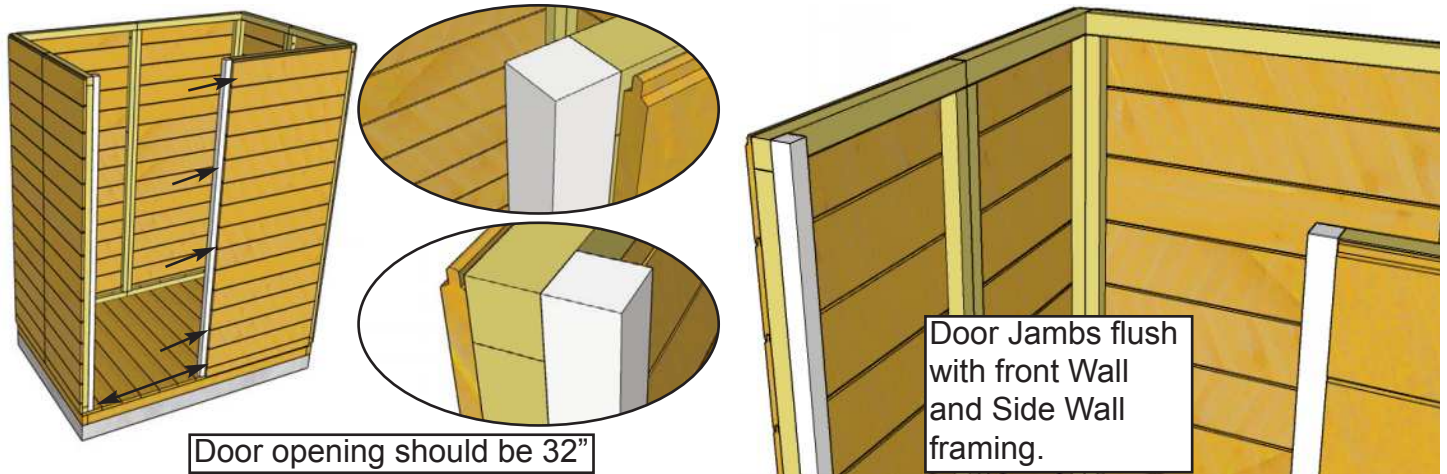

14. Position Door Jambs flush against Front Wall and Side Wall framing and tight to Floor. When positioned correctly, secure Door Jambs using **4 - 2 1/2" Brown Screws**. With both Door Jambs secured, confirm 32" Door opening.

<u>Parts</u> Door Jambs (1 1/2" x 1 1/2" x 72 3/4") x 2	<u>Hardware</u> 2 1/2" Brown Screws x 8 total
--	--

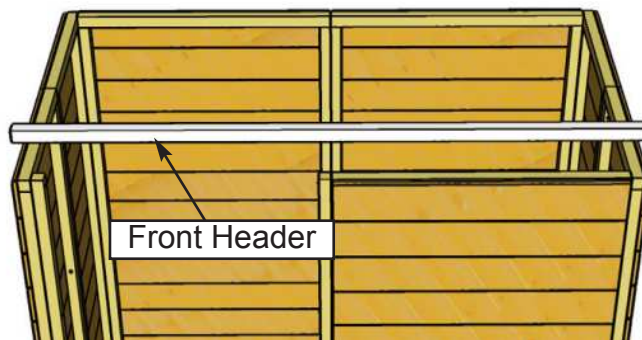

15. Locate **Front Header** and place on top of Window Wall and Side Wall framing.

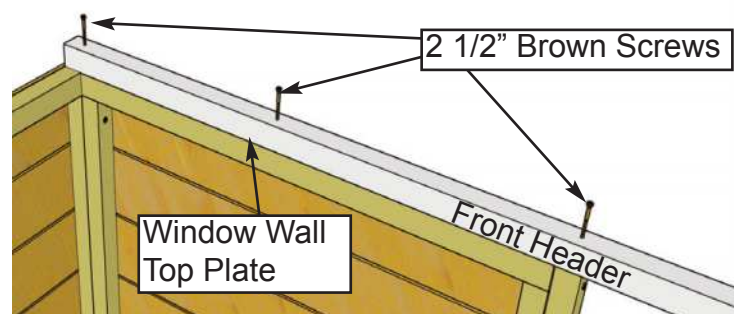
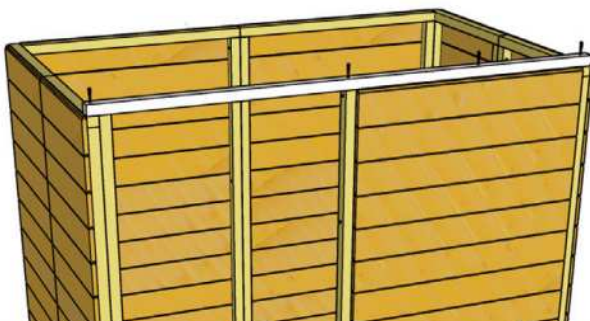

16. With Front Header positioned evenly on Window Wall and Side Wall framing, secure using **4 - 2 1/2" Brown Screws** screwing down from the top of Front Header into the Window Wall and Side Wall top plates.

<u>Parts</u> Front Header (1 1/2" x 1 1/2" x 73")	<u>Hardware</u> 2 1/2" Brown Screws x 4 total
--	--

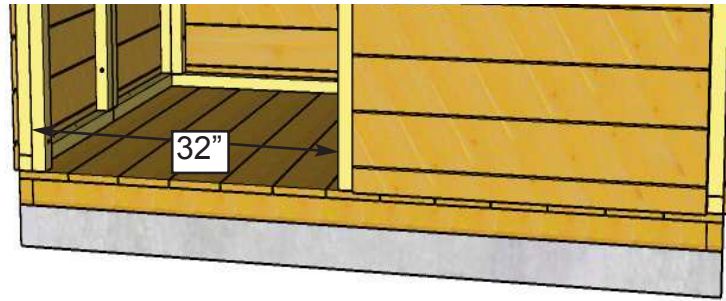

17. When all Walls are attached together, check Door width at top and bottom. Door width should be 32" wide. If required, loosen Window and Side Wall plate screws, adjust Door width and re-secure. There can be an 1/8" tolerance in the width but top and bottom width should be the same.

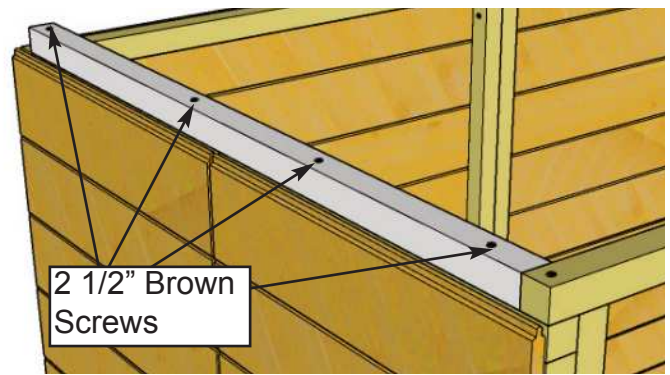
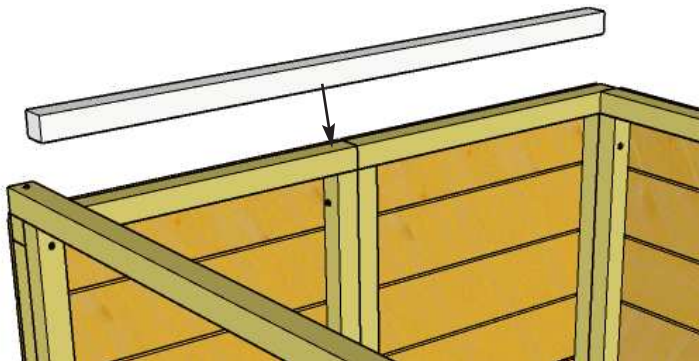

18. Locate and position first **Side Plate** on Side Wall frames so they are flush. Attach Side Plate to Side Wall framing with 4 - **2 1/2" Brown Screws**.

<u>Parts</u> Side Plate (1 1/2" x 1 1/2" x 42")	<u>Hardware</u> 2 1/2" Brown Screws x 4 total
--	--

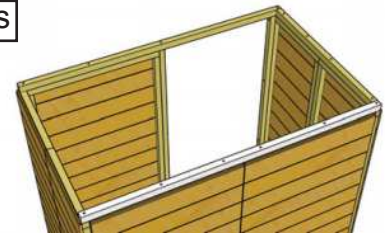
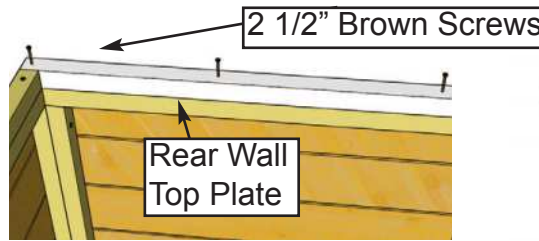
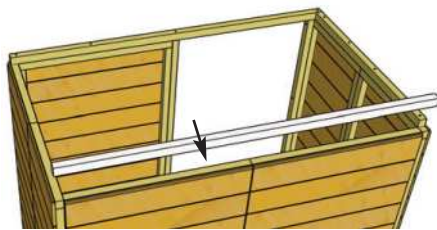

19. Locate **Rear Header** and place on top of Rear Walls. With Rear Header positioned evenly and flush against Rear Wall framing, secure using 6 - **2 1/2" Brown Screws** screwing down from the top of Rear Header down into the Rear Wall top plates.

<u>Parts</u> Rear Header (1 1/2" x 1 1/2" x 73")	<u>Hardware</u> 2 1/2" Brown Screws x 6 total
---	--

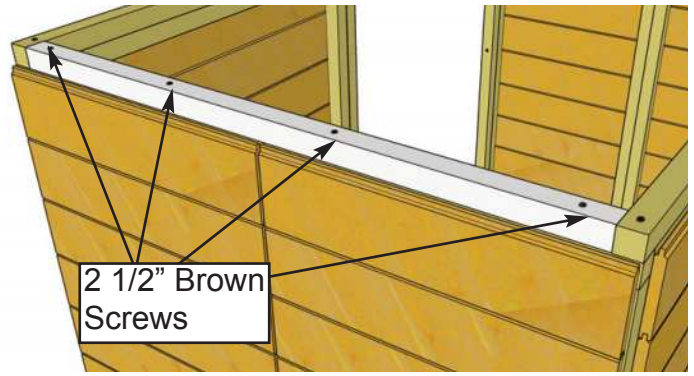
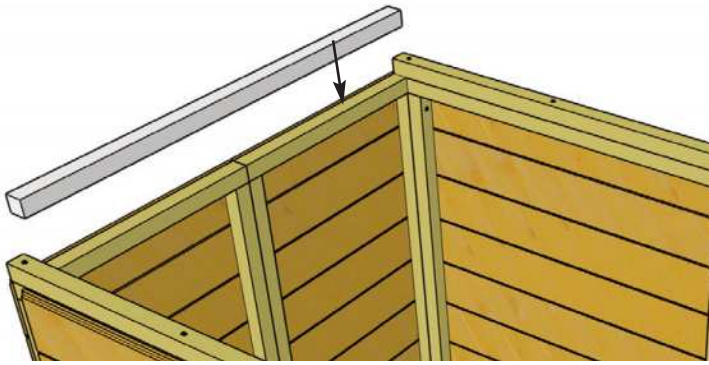

20. Complete opposite **Side Plate** positioning and attachment as per **Step 18**.

<u>Parts</u> Side Plate (1 1/2" x 1 1/2" x 42")	<u>Hardware</u> 2 1/2" Brown Screws x 4 total
--	--

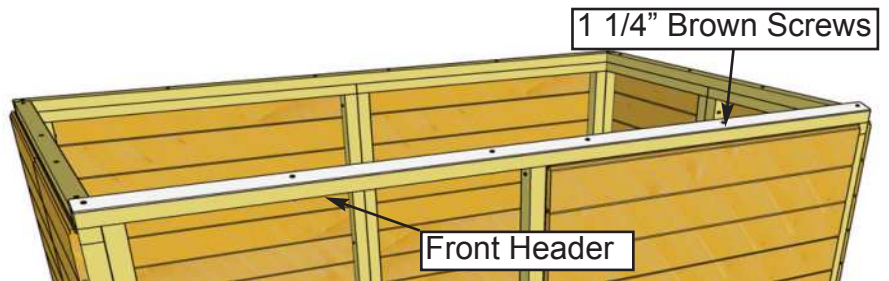
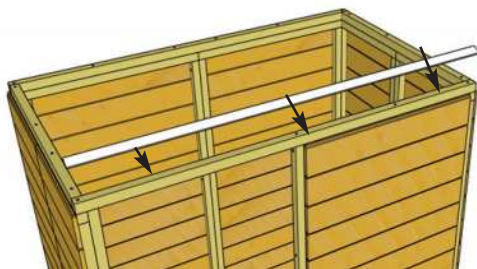

21. Locate **Front Top Plate** and place on top of the **Front Header**. With **Front Top Plate** positioned evenly and flush against **Front Header**, secure using **6 - 1 1/4" Brown Screws** screwing down from the top of **Top Plate** down into **Front Header**.

<u>Parts</u> Front Top Plate - Angle Cut (3/4" x 1 1/2" x 73")	<u>Hardware</u> 1 1/4" Brown Screws x 6 total
---	--

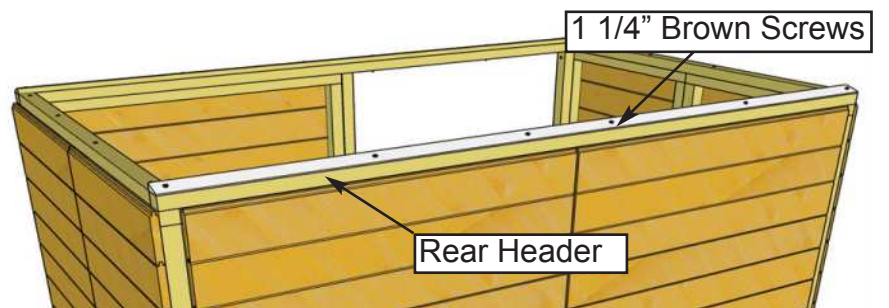
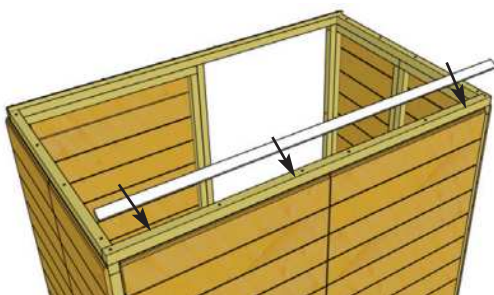

22. Locate **Rear Top Plate** and place on top of **Rear Header**. With **Top Plate** positioned evenly and flush against **Rear Header**, secure using **6 - 1 1/4" Brown Screws** screwing down from the top of **Rear Top Plate** into **Rear Header**.

<u>Parts</u> Rear Top Plate - Angle Cut (3/4" x 1 1/2" x 73")	<u>Hardware</u> 1 1/4" Brown Screws x 6 total
--	--

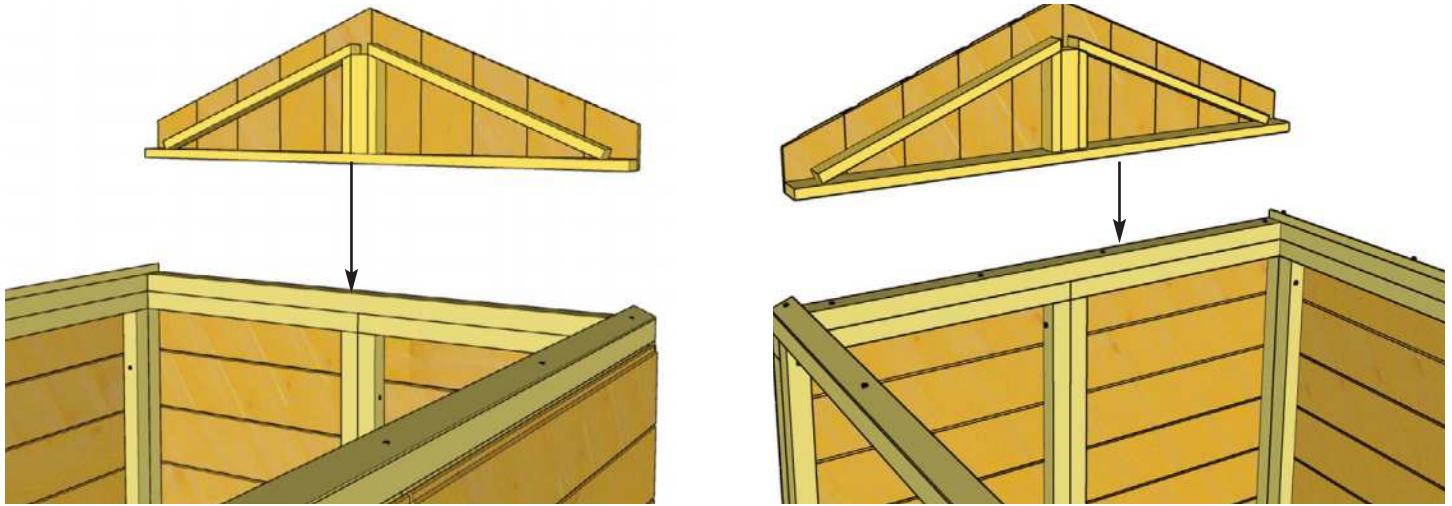

23. Locate both **Gables**. Position Gables on top of Side Walls between Front and Rear Top Plates.

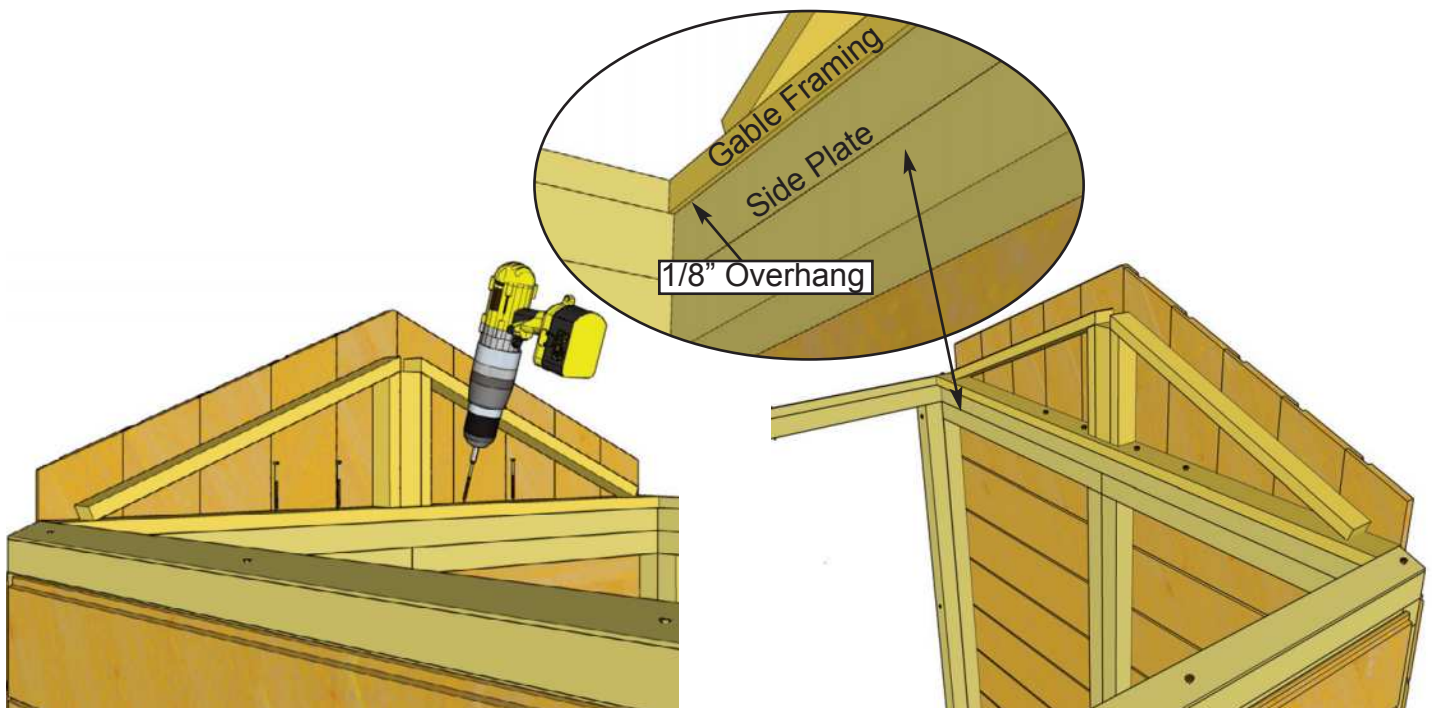

24. Fasten Gables down into Side Plates with 4 - 1 1/4" **Brown Screws**. **Important:** Gable framing will overhang Side Plates by 1/8" on both sides.

<u>Parts</u> Gables (11 3/4" x 42") x 2	<u>Hardware</u> 1 1/4" Brown Screws x 8 total
--	--

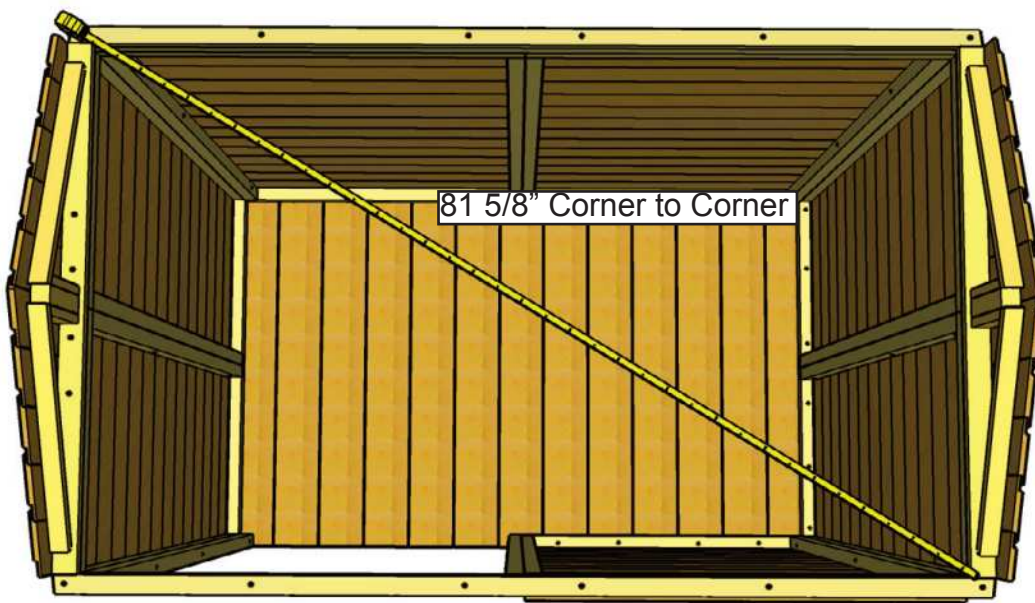
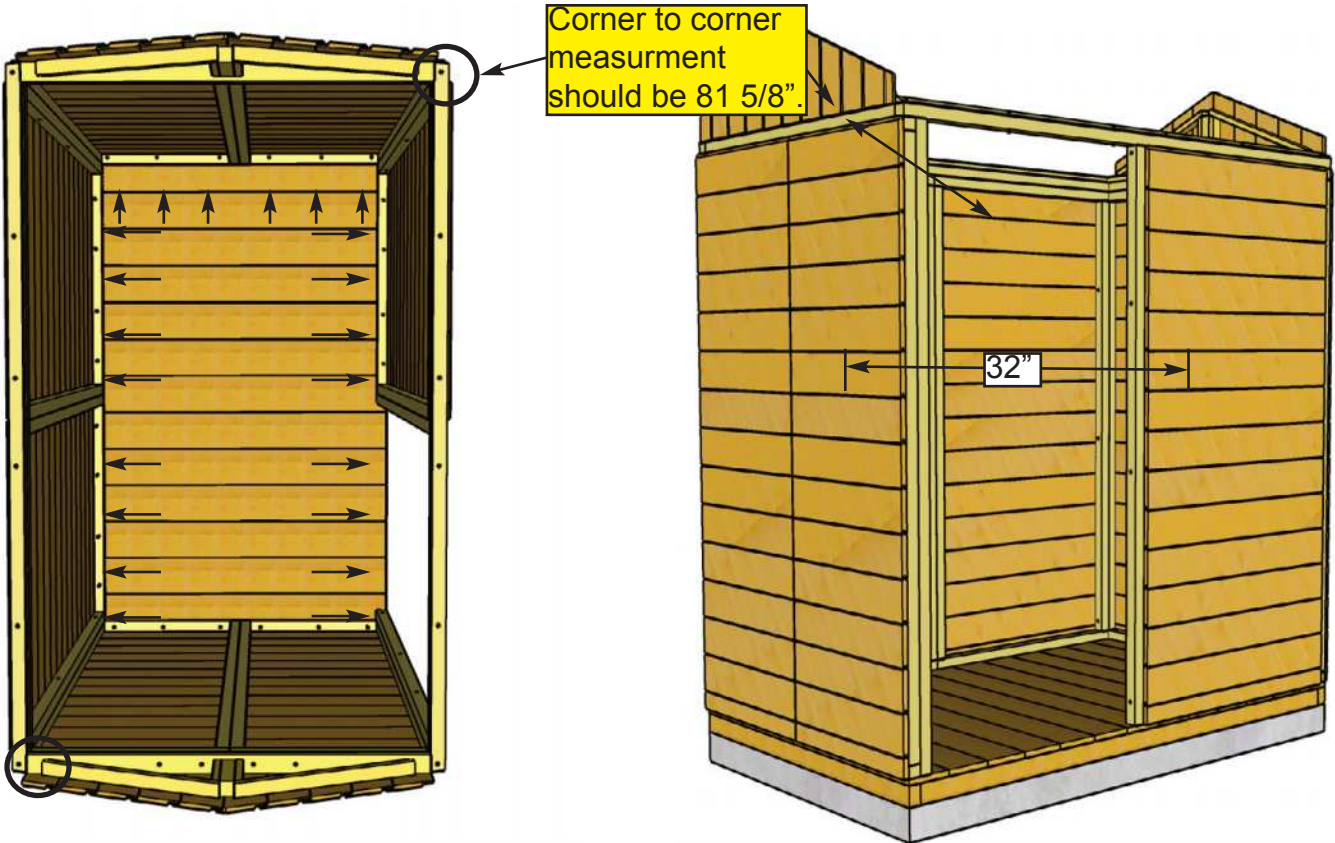

25. With Gables installed, re-confirm doorway opening is 32". Check interior corner to corner measurements are 81 5/8" across diagonally. With doorway measurement confirmed, begin to fasten wall panels down to floor with 2 1/2" Brown Screws. Use **3 - 2 1/2" Brown Screws** per Side Wall and **4 - 2 1/2" Brown screws** per Front/Rear Wall. Screw through Bottom Wall Plate into floor. Note: Rear Left Wall already fastened down in Step 4.

Hardware
2 1/2" Brown Screws
 x 20 total

C. Rafter & Roof Section

Exploded view of all parts necessary to complete the Rafter and Roof Section. Identify all parts prior to starting.

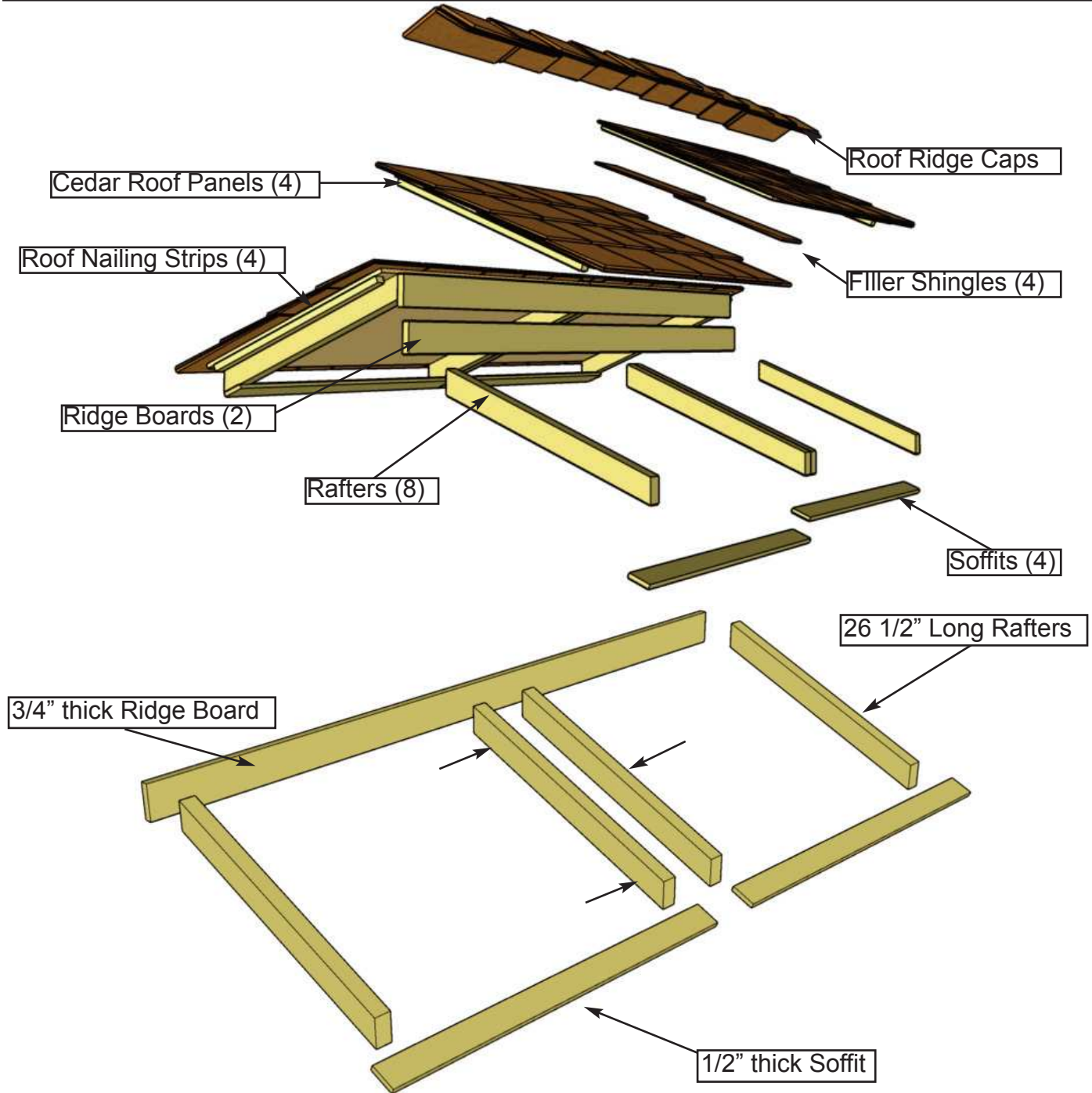

26. Locate 8 **Rafters**, 2 **Ridge Boards**, and 4 **Soffits**. Evenly space out Rafters and lay out as illustrated, on a flat level surface. Screw doubled up **Rafters** together with 3 - 2 1/2" **Brown Screws**.

<p><u>Parts</u></p> <p>Ridge Boards (3/4" x 3 1/2" x 73") x 2</p> <p>Rafters (1 1/2" x 2 1/2" x 26 1/2") x 8</p>	<p>Soffits (1/2" x 2 1/2" x 36 1/2") x 4</p> <p><u>Hardware</u> 2 1/2" Brown Screws x 3 total</p>
--	---

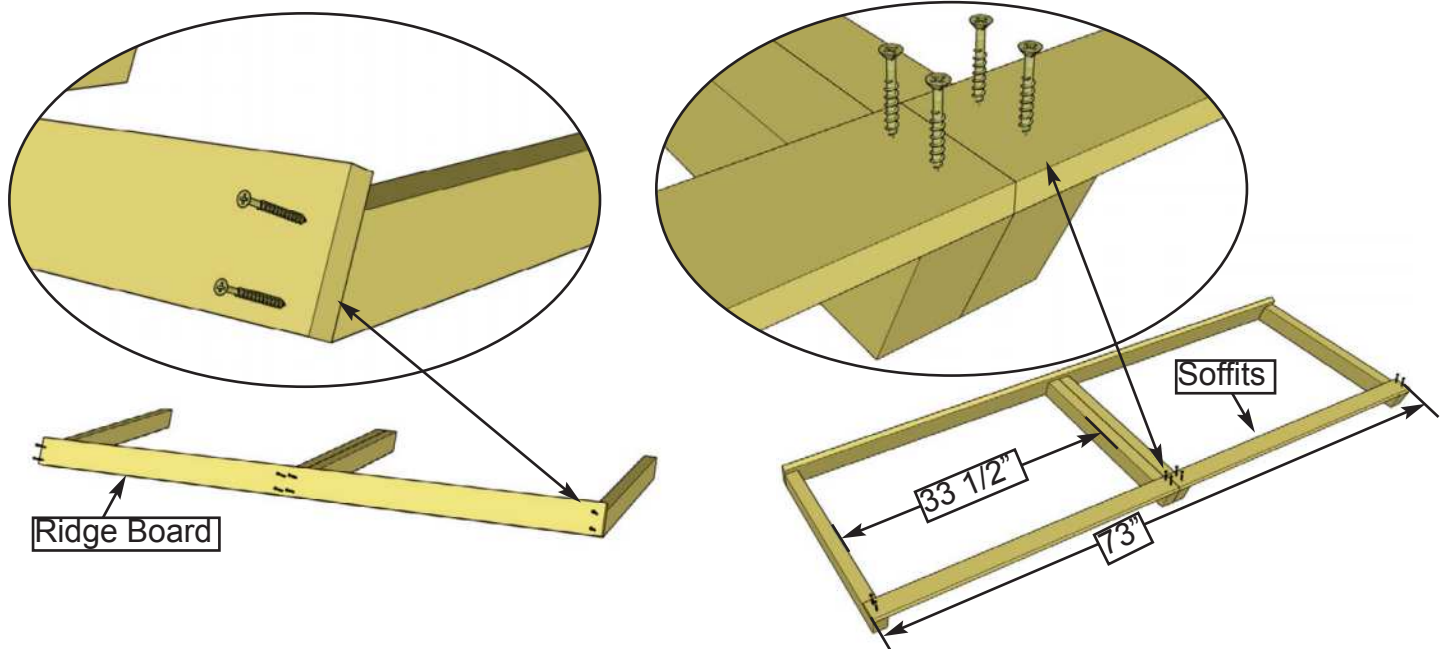

Important: Pilot Hole Ridge Board and Soffit prior to screwing to prevent splitting!

27. Attach **Ridge Board** to ends of both outside **Rafters** with **2 - 2" Brown Screws** per end. Drill a 1/8" pilot holes in Ridge Board to prevent splitting. Rafters should be 33 1/2" apart. Position **Soffits** on underside of Rafters on opposite end from Ridge Board. Screw Soffits into Rafters with **2 - 1 1/4" Brown Screws** per rafter.

Parts	
Ridge Board	(3/4" x 3 1/2" x 73") x 1
Rafters	(1 1/2" x 2 1/2" x 26 1/2") x 4
Soffits	(1/2" x 2 1/2" x 36 1/2") x 2

Hardware	
2" Brown Screws	x 8 total
1 1/4" Brown Screws	x 8 total

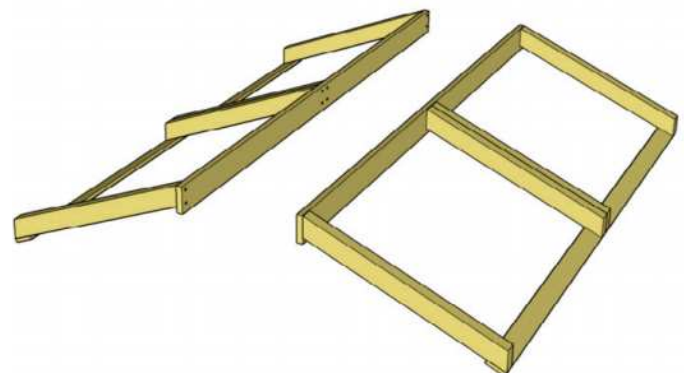
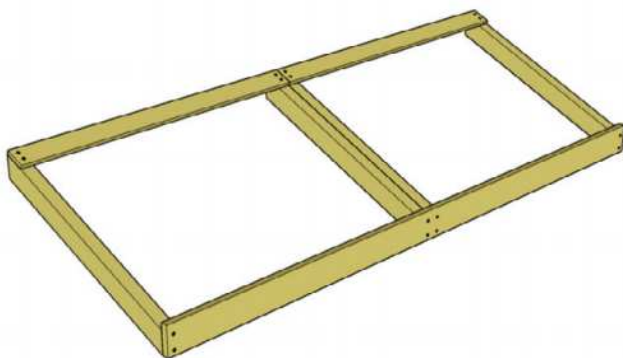

28. Repeat **Step 17** with remaining Rafter section components to assemble a second rafter section. Flip assembled Rafter Sections over once complete.

Hardware	
2" Brown Screws	x 8 total
1 1/4" Brown Screws	x 8 total

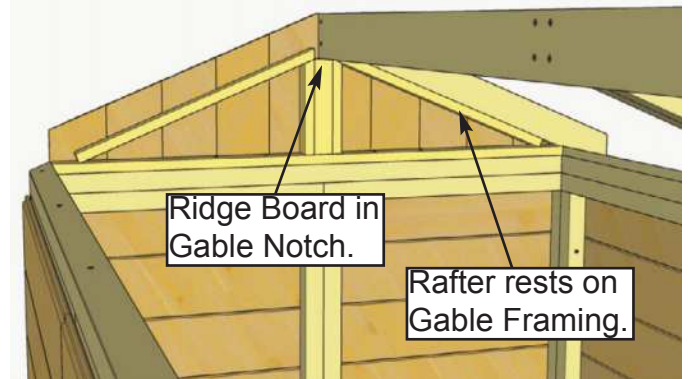
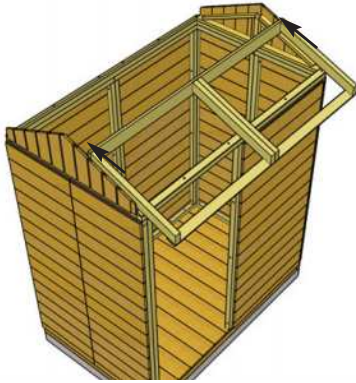

29. With a helper, lift one Rafter section onto shed. Slide the Rafter section up the Gables until the Ridge Board lands in the notch in the Gable.

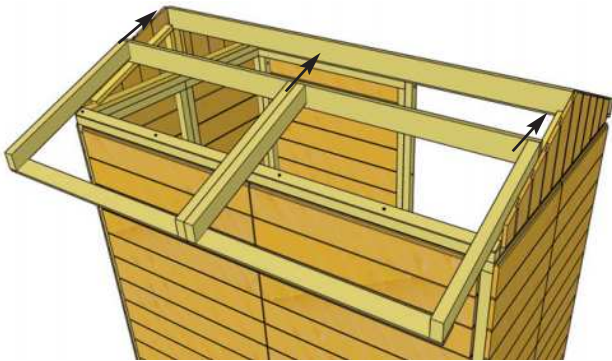

30. Repeat **Step 29** to lift second Rafter section onto shed.

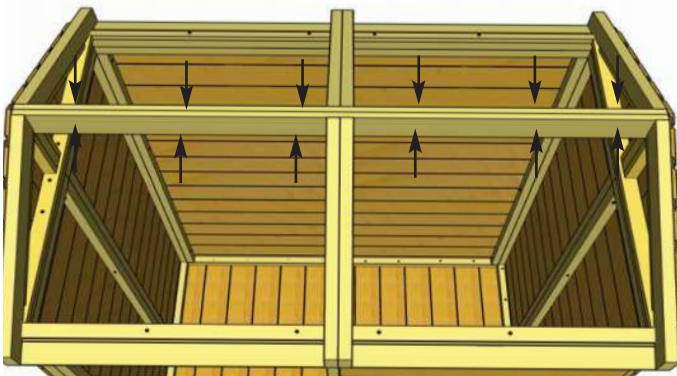

31. Align Ridge Boards together so the tops are flush at the peak. Screw Ridge Boards together with **6 - 1 1/4" screws** per side.

Hardware
1 1/4" Brown Screws
 x 12 total

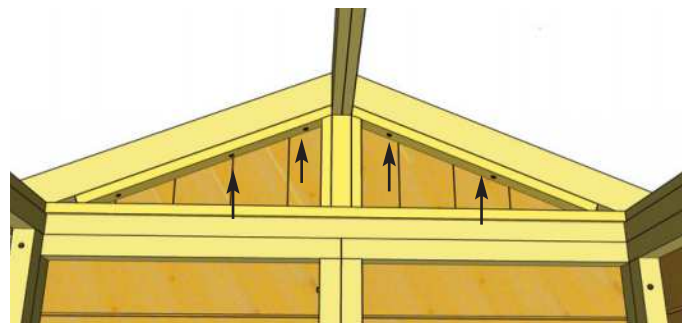

32. With Ridge Boards secured, fasten Gables to Rafters with **4 - 2" Brown Screws** per Gable.

Hardware
2" Brown Screws
 x 8 total

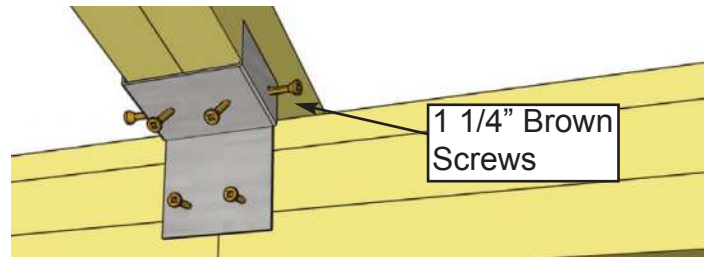
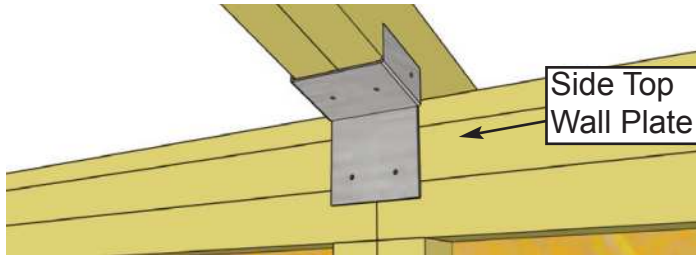

33. Attach middle Rafter to Side Top Wall Plate inside of shed using a Rafter Bracket and 6 - 1 1/4" Brown Screws. Complete attachment of opposite middle Rafter.

Hardware

Rafter Bracket x 2 total

1 1/4" Brown Screws x 12 total

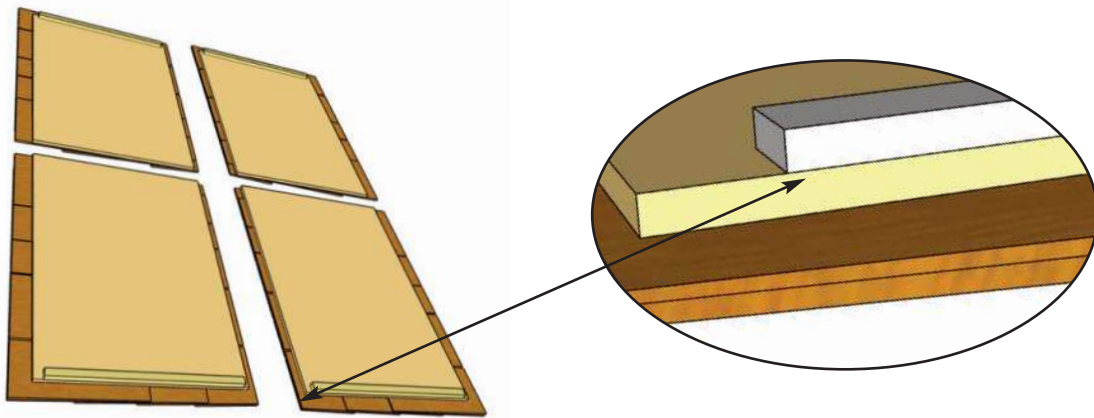

34. Carefully flip Cedar Shingle Roof Panels over so plywood is facing up. Attach Roof Nailing Strips onto outside of each panel flush with plywood. Attach with 3 - 1 1/4" Brown Screws evenly spaced. Nailing Strips provide for a greater nailing surface later when you attach Front/Rear Fascia Trim.

Parts

Roof Nailing Strips (3/4 x 1" x 24 1/2") x 4

Hardware

1 1/4" Brown Screws x 12 total

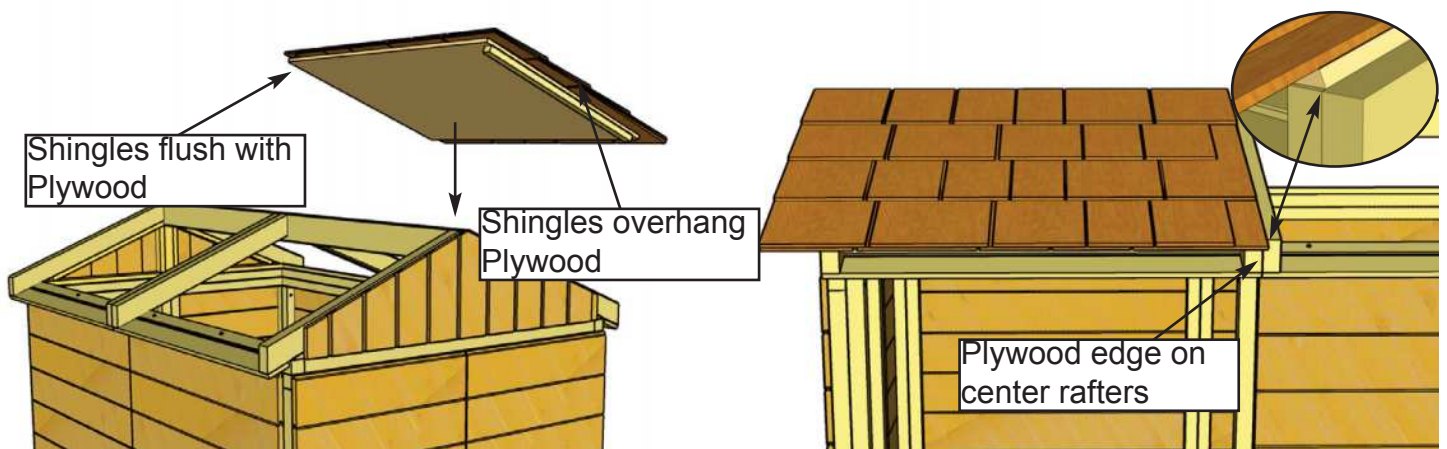

35. Position first Cedar Roof Panel on top of shed. Roof Panel should be flush with the seam in doubled up rafters. Recess Roof Panel 1/8" from end of Rafter.

Parts Steps (35 - 39)

Cedar Roof Panels (28 3/8" x 41") x 4

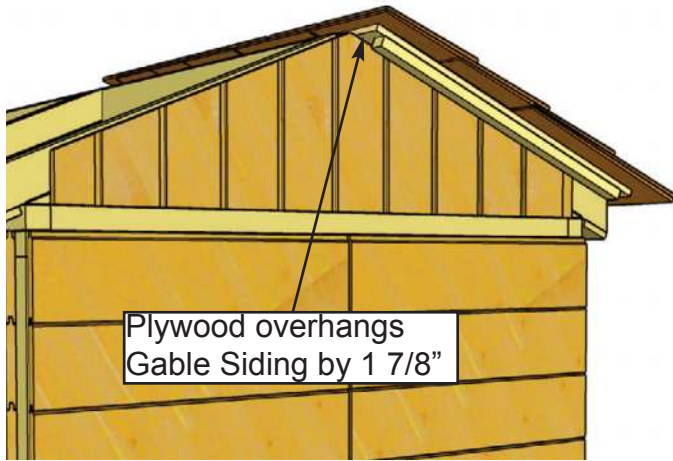

36. With Cedar Roof Panel in position, screw panel down in the bottom corner with 1 - 2 1/2" Brown Screw into the bottom row of shingles.

Hardware
2 1/2" Brown Screw
x 1 total

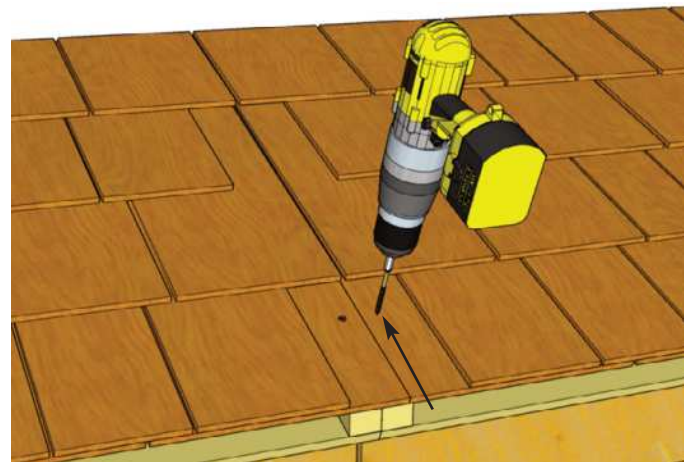
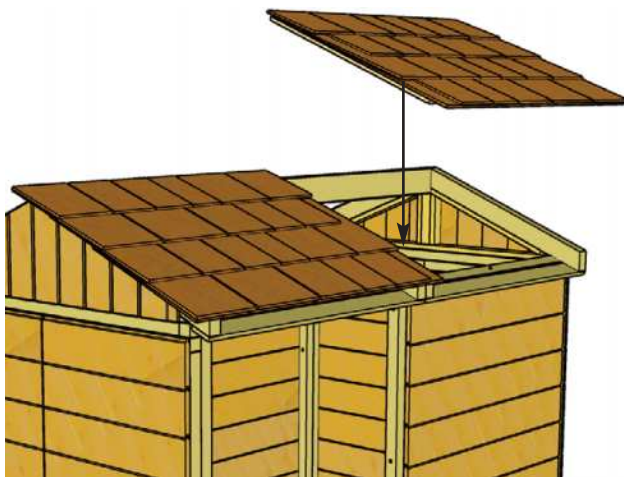

37. Position second Cedar Roof Panel on Roof next to the previous as per Step 26. Screw Panel down to rafters with 1 - 2 1/2" Brown Screw.

Hardware
2 1/2" Brown Screw
x 1 total

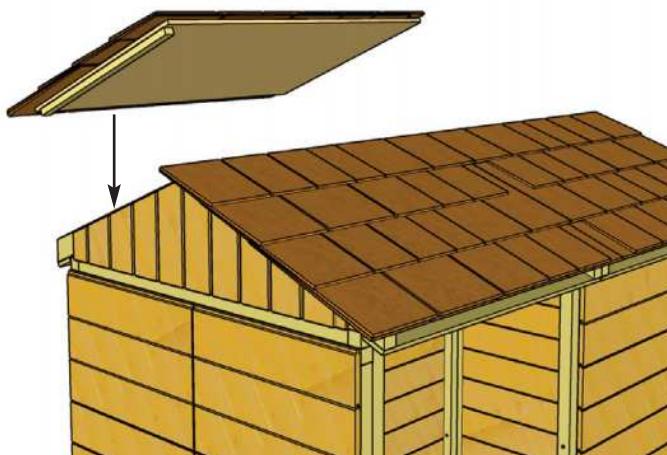

38. Switch to opposite side of Roof and place first Cedar Roof Panel down as per Step 35. When positioned correctly screw Panel down to Rafter with 1 - 2 1/2" Brown Screw.

Hardware
2 1/2" Brown Screw
x 1 total

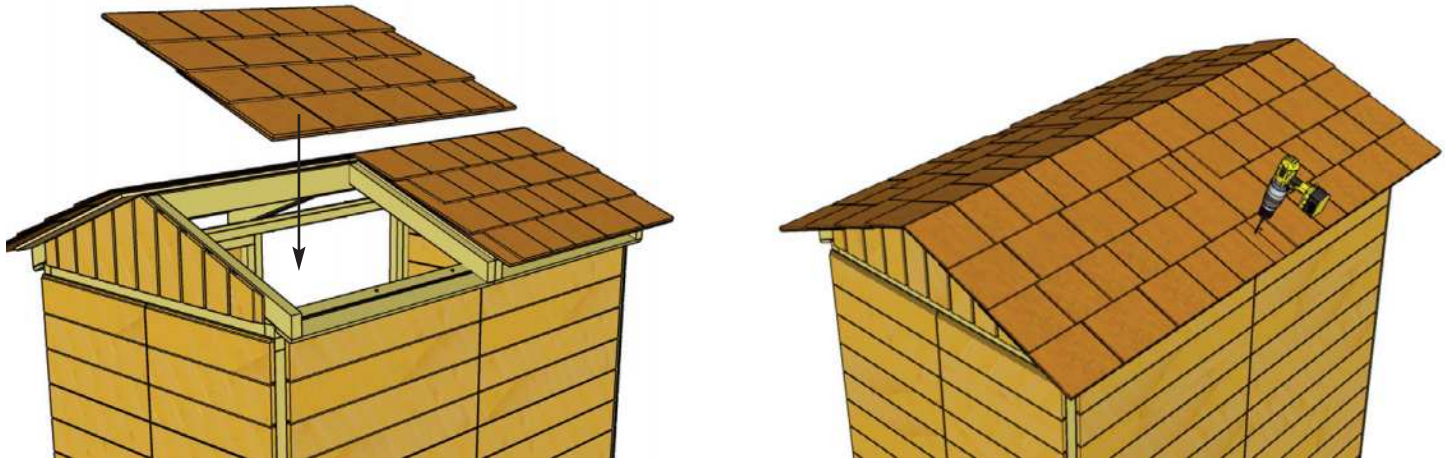

39. Position second Cedar Roof Panel on Roof next to the previous as per **Step 37**. Screw Panel down to Rafters with **1 - 2 1/2" Brown Screw**.

Hardware
2 1/2" Brown Screw
 x 1 total

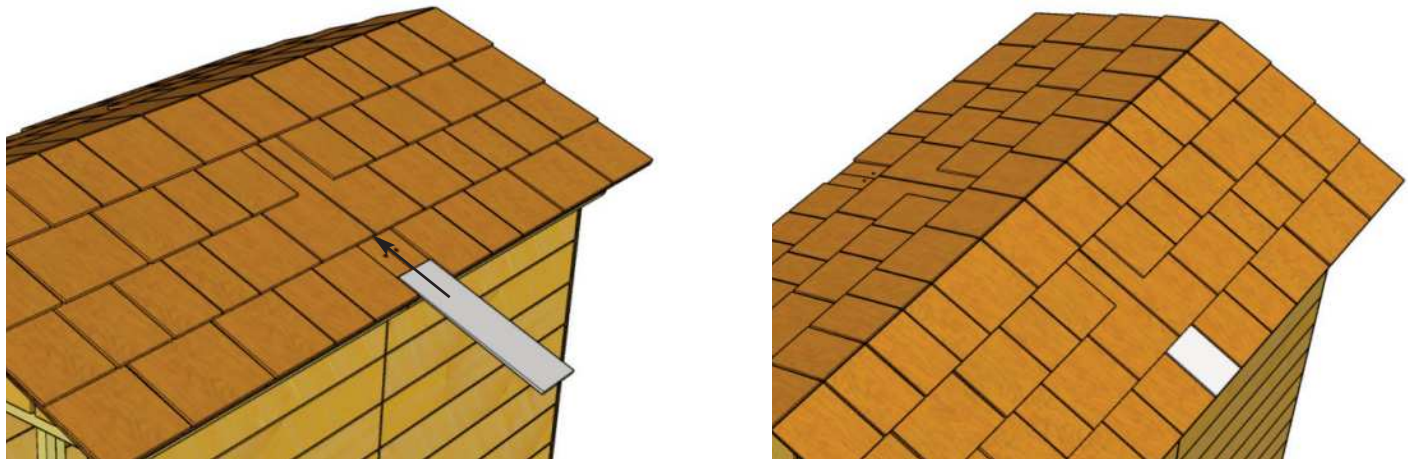

40. Roof Filler Shingles are included to cover Roof seams. Starting at the bottom, slide first Long Filler Shingle in until flush with other Shingles.

Parts
Filler Shingles Long
 (5" x 16") x 1

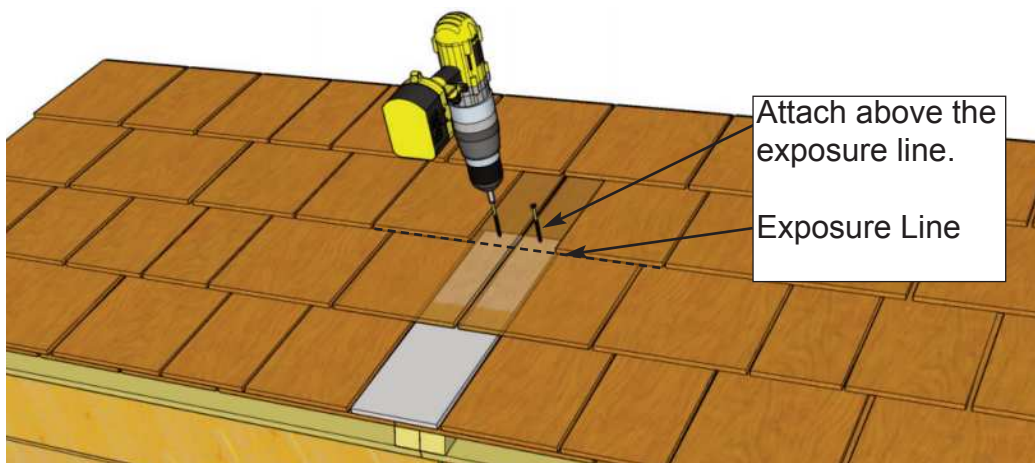

41. Screw first **Filler Shingle** down to Rafters using **2 - 2 1/2" Brown Screws**(1 per panel). Make sure to screw into both Rafters.

Hardware (Step 41 - 42)
2 1/2" Brown Screws
 x 4 total

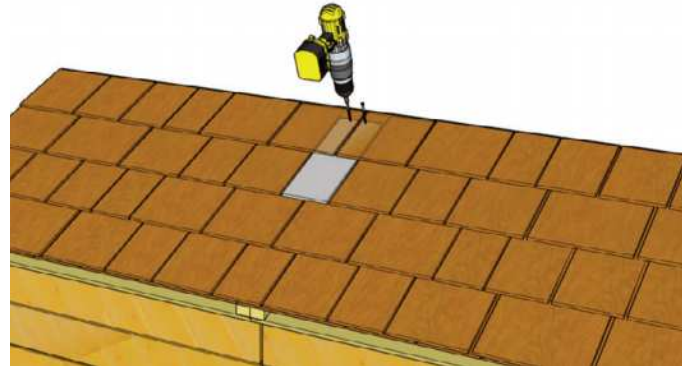
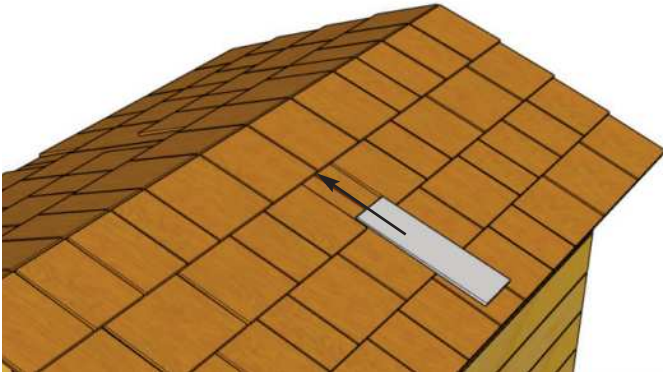

42. Slide one of the shorter Filler Shingles in the next row up, and attach as per **Step 41**.

Parts
Filler Shingles Short
 (5" x 13 7/8") x 1

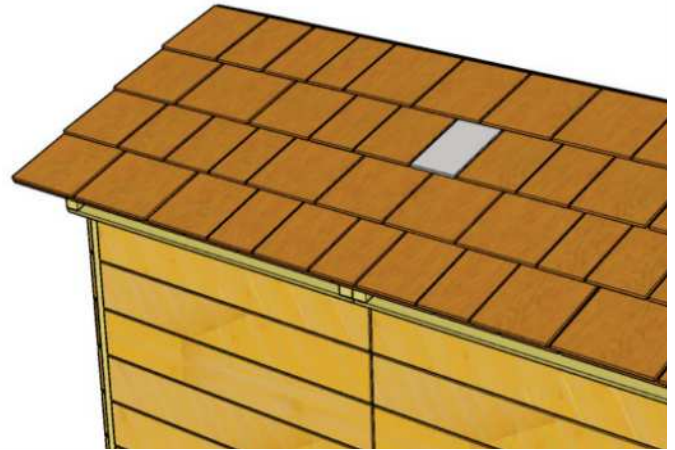
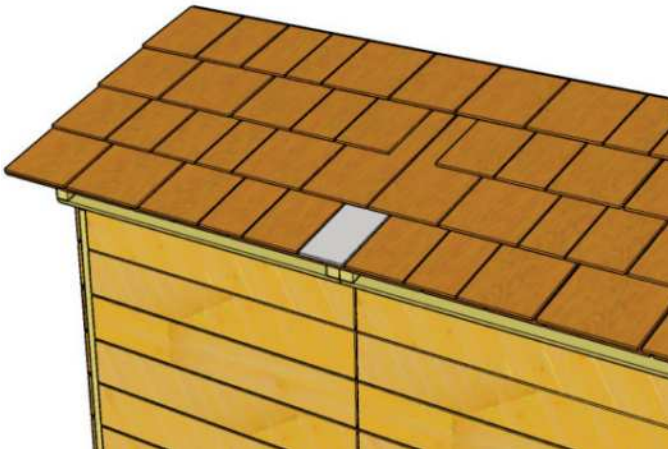

43. Repeat **Steps 40 - 42**. To install one Long & one Short Filler Shingle on the opposite side.

Parts
Filler Shingles Long
 (5" x 16") x 1
Filler Shingles Short
 (5" x 13 7/8") x 1

Hardware
2 1/2" Brown Screws
 x 4 total

Alternate Ridge Cap seams (offsetting angle cut at peak)

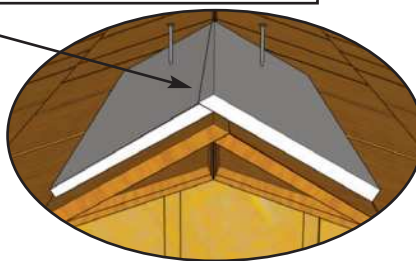
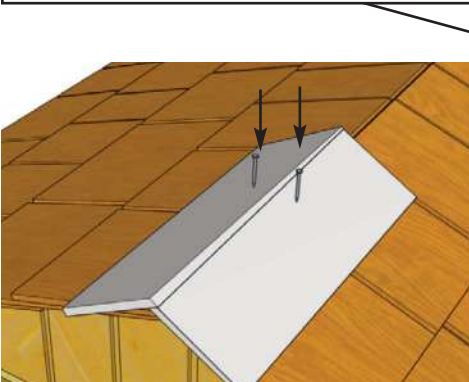

Important: Butt (thick) end of Ridge Cap will be facing towards the outside of shed.

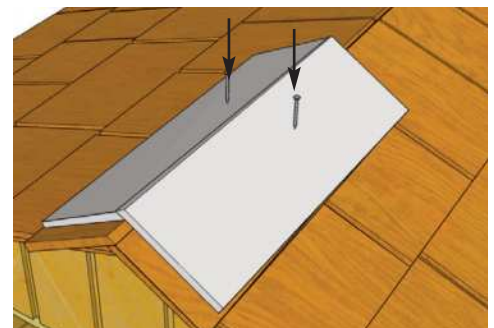

44. Place first **Roof Ridge Cap** on roof peak overhanging shingles by approximately 1". Attach with **2 - 1 1/2" Shingle Nails** 9" from end. Place second Ridge Cap 1" back from first Cap. Attach with **2 - 1 1/2" Shingle Nails** 9" from end. Alternate each Ridge Cap seam as you proceed.

Parts
Roof Ridge Caps (5" x 16") x 2

Hardware
1 1/2" Shingle Nails x 4

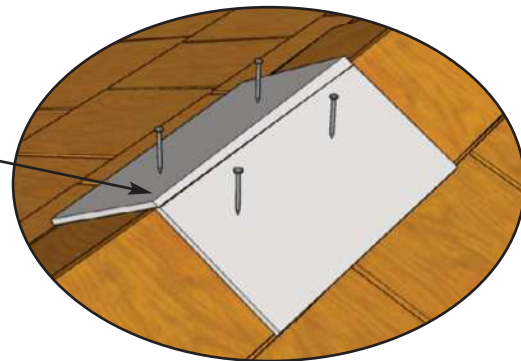
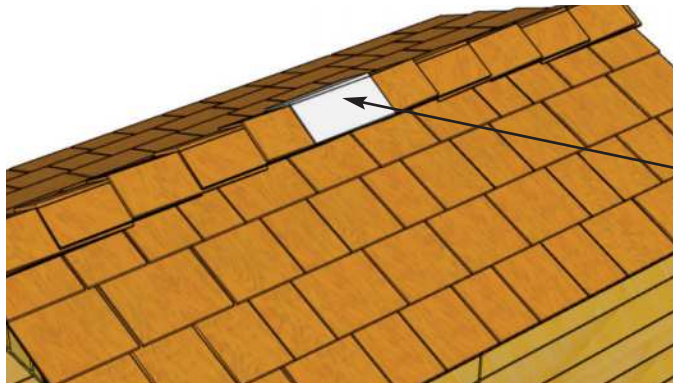
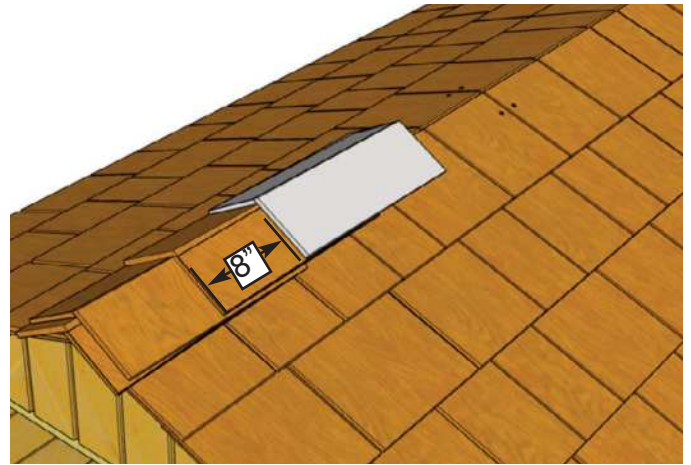

45. Place third **Ridge Cap** 8" back from second (enough to cover shingle nails). Attach third Ridge Cap as per **Step 44**. Continue to position and attach Ridge Caps until half the roof is complete. From opposite side, position and attach Ridge Caps as described above. One Ridge Cap is cut shorter to fit in the center of the Roof. Attach center cap with **4 - 1 1/2" Shingle Nails**.

Parts
Roof Ridge Caps
 (5" x 16") x 10
Roof Ridge Caps
 (5" x 10") x 1

Hardware
1 1/2" Shingle Nails
 x 24 total

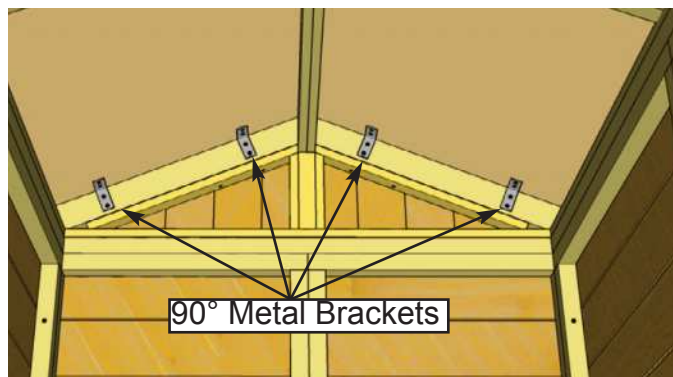

46. Inside the shed, position **8 - 90° Metal Brackets** onto the Roof plywood and Rafters and secure with **4 - 3/4" Silver Screws** in each Bracket. For each Roof Panel, 4 - 90° Metal Brackets will be used for the outside Rafters and 2 - 90° Metal Brackets will be used to secure the middle Rafter.

Hardware
90° Metal Brackets x 8 total
3/4" Silver Screws x 32 total

D. Miscellaneous Section

Exploded view of all parts necessary to complete the Skirting, Trim, Fascia and Miscellaneous Pieces. Identify all parts prior to starting.

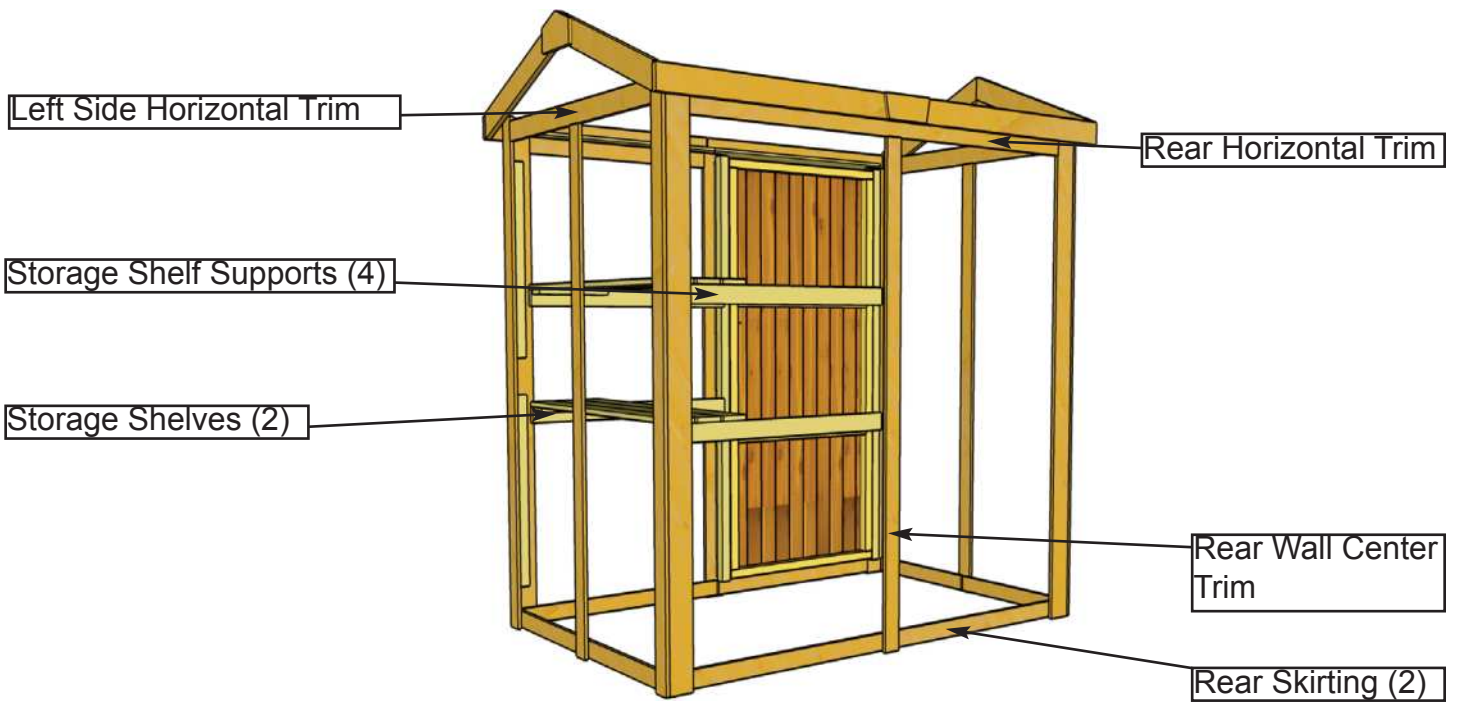
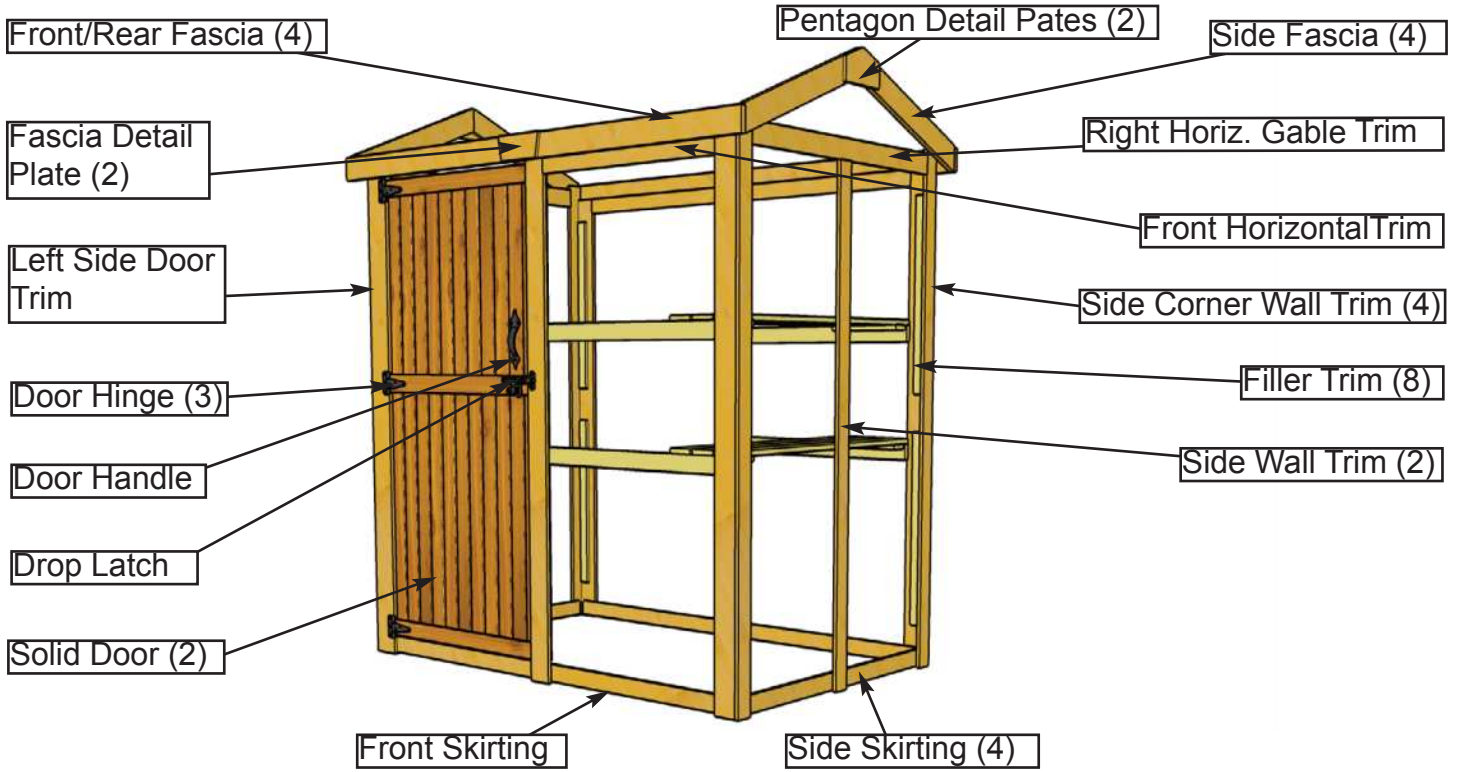



47. Check the wall seams for visible gaps prior to attaching Filler Trim and apply caulk where needed. Caulking gaps will help prevent moisture from entering and will help the longevity of your shed. **Caulking not included in kit.**

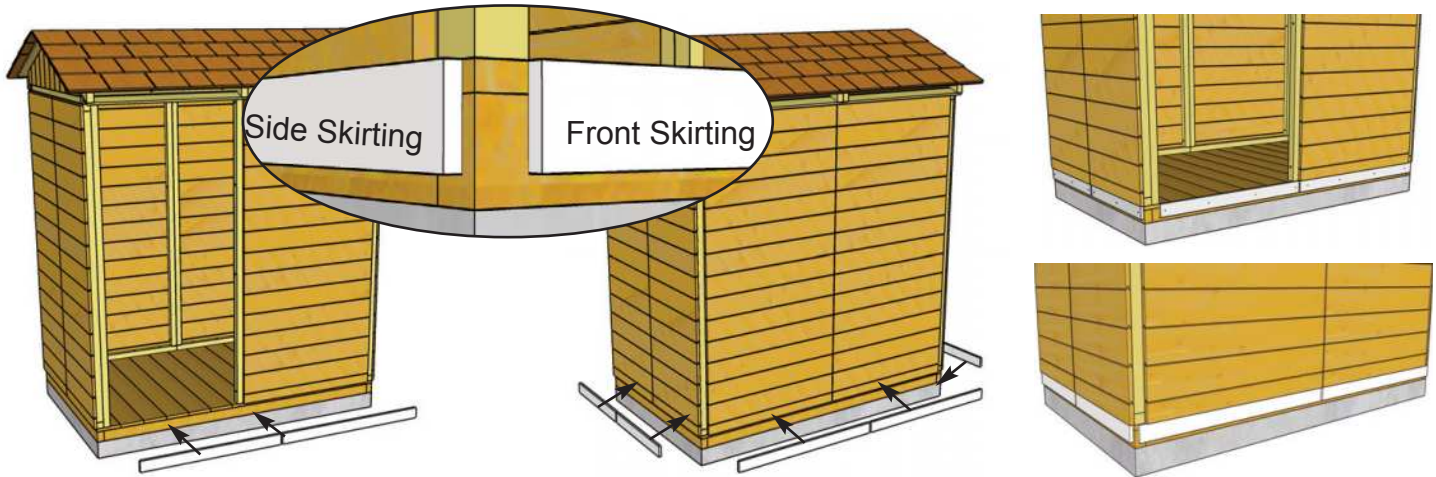

48. Locate **Front and Doorway Skirting**. Skirting will hide Floor framing. Gaps will be covered by Wide Trim. Attach Front and Doorway Skirting with **4 - 1 1/2" Finishing Nails**. Locate **Side Skirting** and attach with **3 - 1 1/2" Finishing Nails** per piece and **Rear Skirting** with **4 - 1 1/2" Finishing Nails** per piece.

Parts	Hardware
Front /Rear Skirting (1/2" x 2 1/2" x 35 3/4") x 3 Side Skirting (1/2" x 2 1/2" x 21 3/4") x 4 Doorway Skirting (1/2" x 2 1/2" x 33 1/4")	1 1/2" Finishing Nails x 28 total

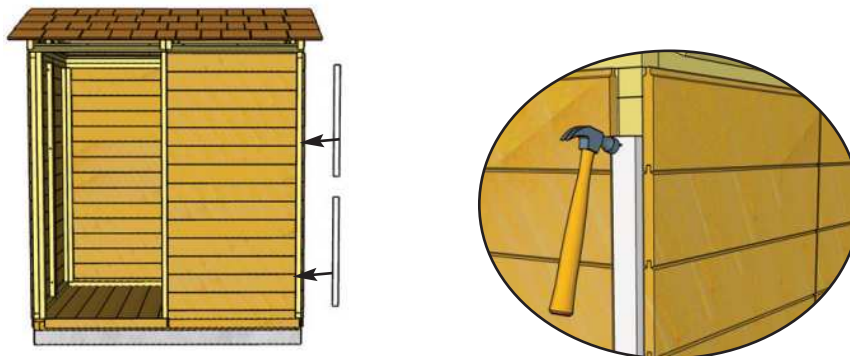

49. Locate 2 **Front Filler Trims**. Filler trim will be covered by Corner Trim in **Step 53**. Attach in right front corner with **3 - 1 1/2" Finishing Nails** per piece.

Parts (Step 49 - 50)	Hardware (Step 49 - 50)
Front/Rear Filler Trims (5/8" x 1 1/2" x 30") x 6	1 1/2" Finishing Nails x 18 total

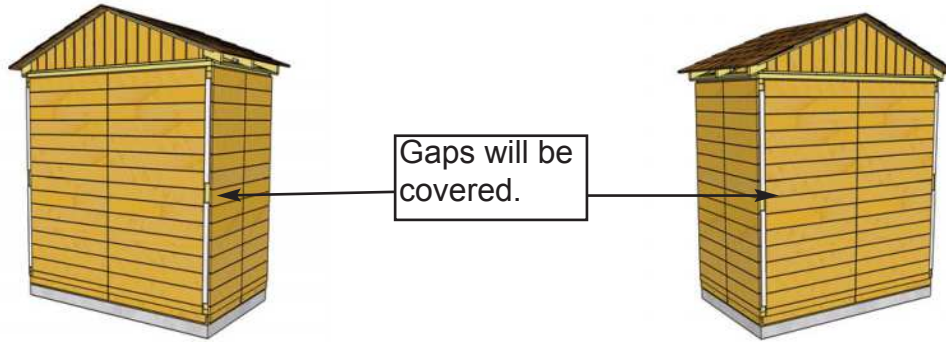

50. Position and attach **Rear Filler Trims** at the rear as per **Step 49**.



51. Locate the **Doorway Filler Strip** and position on Door Jamb. Secure with **6 - 1 1/2"** **Finishing Nails** into Door Jamb.

Parts
Doorway Filler Strip
 (5/8" x 1 1/2" x 71")

Hardware
1 1/2" Finishing Nails
 x 6 total



52. Locate **Side Gable Filler Strips**. Position on Side Plate. Evenly space from side to side. Secure with **4 - 1 1/2"** **Finishing Nails** into Side Plate. Complete opposite side with same positioning and attachment.

Parts
Side Gable Filler Strips
 (5/8" x 1 1/2" x 42") x 2

Hardware
1 1/2" Finishing Nails
 x 8 total

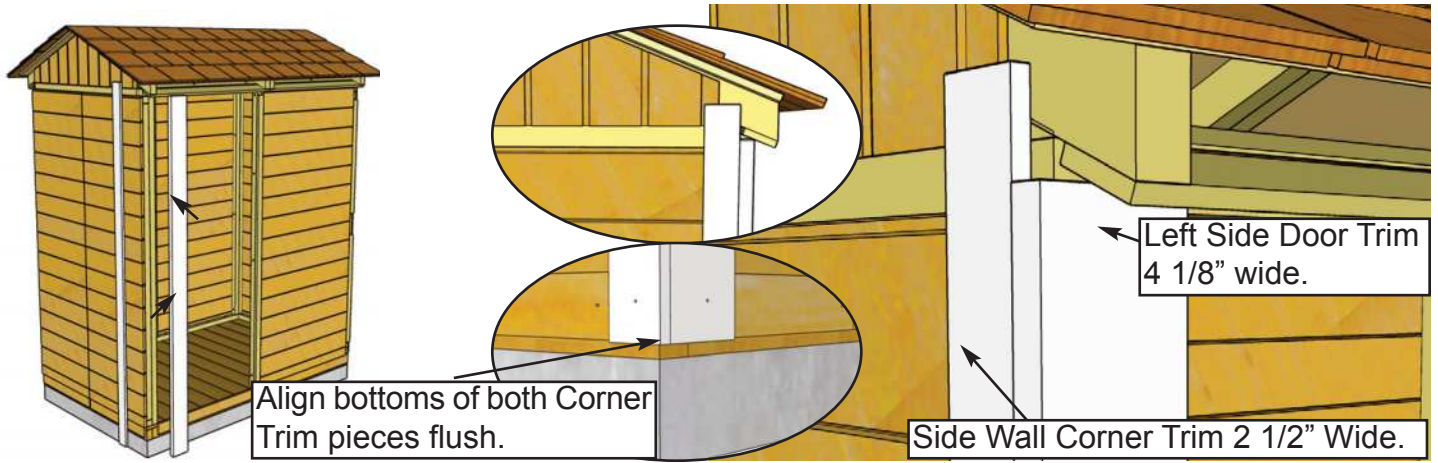

53. Locate a **Left Side Door Trim** and **Side Wall Corner Trim**. Starting in one corner, position both Trims up underneath Cedar Roof and Soffit. Align bottom of Left Side Door Trim with bottom of Side Wall Corner Trim. Left Side Door Trim will cap Side Wall Corner Trim. When correctly aligned, attach each piece with **6 - 1 1/2" Finishing Nails**.

<u>Parts</u>	<u>Hardware</u>
Left Side Door Trim (1" x 4 1/8" x 76") Side Wall Corner Trim (1/2" x 2 1/2" x 78 1/2")	1 1/2" Finishing Nails x 12 total

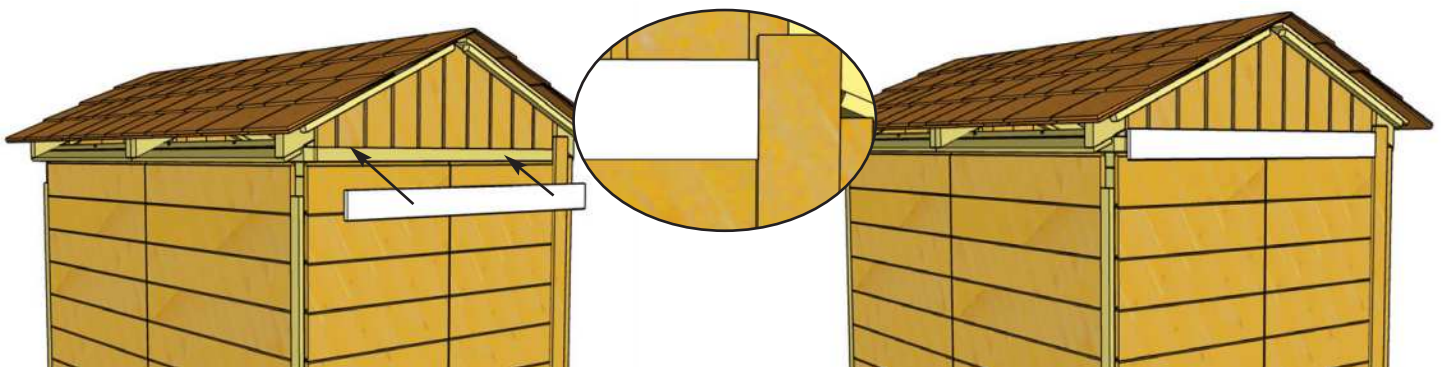

54. Locate **Left Horizontal Gable Trim** and align tight against Side Wall Corner Trim. Attach with **4 - 1 1/2" Finishing Nails** into Side Gable Filler Strip.

<u>Parts</u>	<u>Hardware</u>
Horizontal Gable Trim - Left (1/2" x 3" x 41 1/8")	1 1/2" Finishing Nails x 4 total

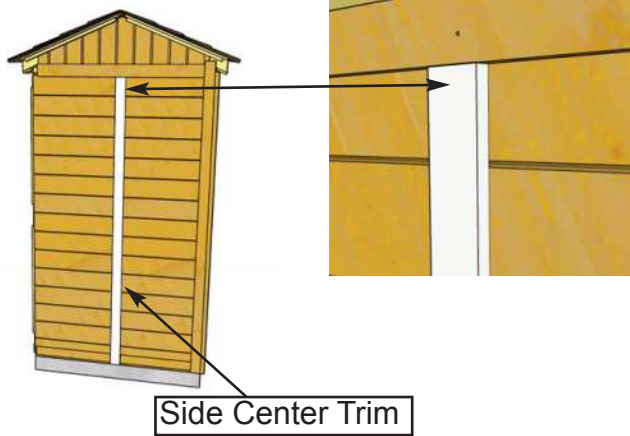

55. Locate **Side Wall Trim**. Place in the center of the two side walls. Attach trim tight underneath Horizontal Gable Trim with **6 - 1 1/2" Finishing Nails**.

Parts

Side Wall Trim
(1/2" x 2 1/2" x 74 3/4")

Hardware

1 1/2" Finishing Nails
x 6 total

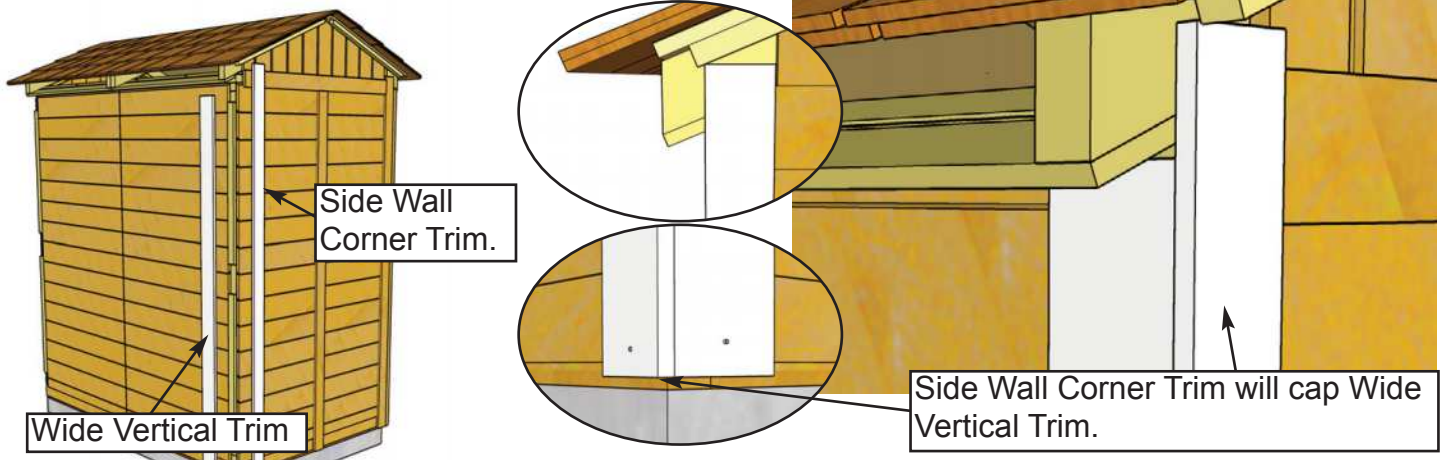

56. Locate a **Side Wall Corner Trim** and **Wide Vertical Trim** and position both Trims up underneath Cedar Roof and Soffit. Align Wide Vertical Trim with bottom of Side Wall Corner Trim. Side Wall Corner Trim will cap Wide Vertical Trim. When correctly aligned, attach each piece with **6 - 1 1/2" Finishing Nails**.

Parts

Wide Vertical Trim
(1/2" x 3 1/2" x 76")
Side Wall Corner Trim
(1/2" x 2 1/2" x 78 1/2")

Hardware

1 1/2" Finishing Nails
x 12 total

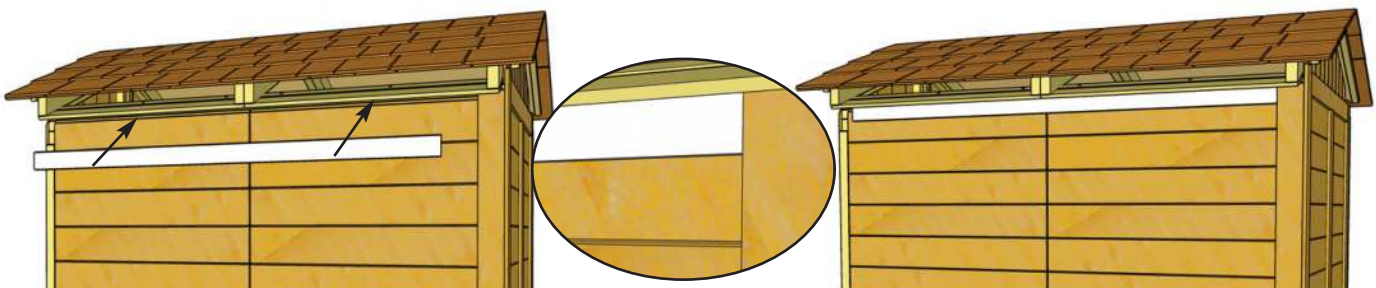

57. Locate **Rear Horizontal Trim** and align tight underneath Soffit and against Wide Vertical Trim. Attach with **6 - 1 1/2" Finishing Nails**.

Parts

Rear Horizontal Trim
(1/2" x 2 1/2" x 67 1/4")

Hardware

1 1/2" Finishing Nails
x 6 total

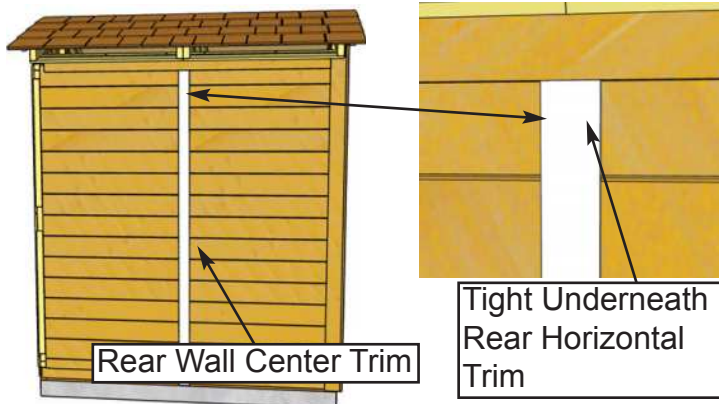

58. Locate **Rear Wall Center Trim**. Align tight against Rear Horizontal Trim and attach with **6 - 1 1/2" Finishing Nails**.

<u>Parts</u>	
Rear Wall Center Trim (1/2" x 2 1/2" x 73 1/2")	
<u>Hardware</u>	
1 1/2" Finishing Nails x 6 total	



59. Complete other Wide Vertical, Side Wall Corner, Side Wall and Right Horizontal Gable Trims. Note: The Side Wall Corner Trim will cap the Wide Vertical Trim on the right side.

<u>Parts</u>	
Wide Vertical Trim (1/2" x 3 1/2" x 76") x 2	
Side Wall Corner Trim (1/2" x 2 1/2" x 78 1/2") x 2	
Horizontal Gable Trim - Right (1/2" x 3" x 42 1/4")	
Side Wall Trim (1/2" x 2 1/2" x 74 3/4")	
<u>Hardware</u>	
1 1/2" Finishing Nails x 34 total	

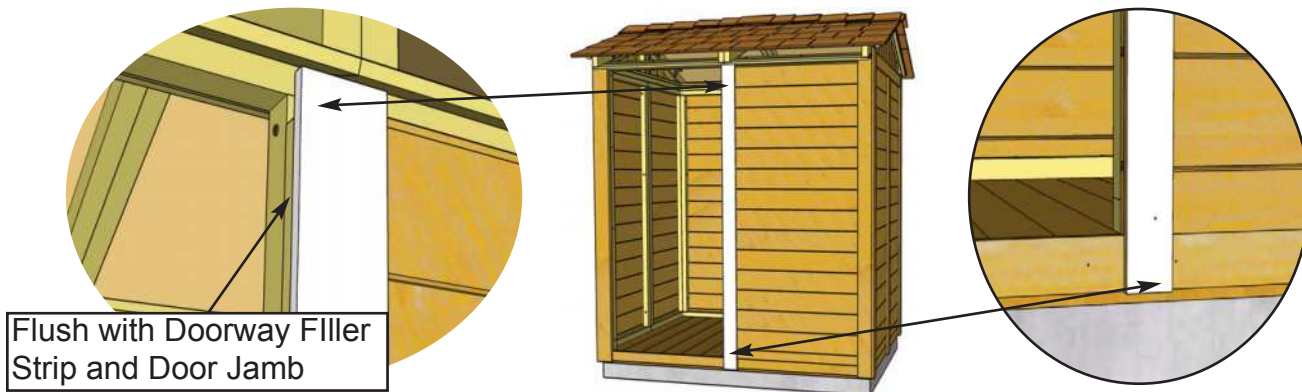

60. Locate another **Wide Vertical Trim**. Position on and flush with Doorway Filler Strip. Attach with **6 - 1 1/2" Finishing Nails** into Doorway Filler Strip.

<u>Parts</u>	
Wide Vertical Trim (1/2" x 3 1/2" x 76)	
<u>Hardware</u>	
1 1/2" Finishing Nails x 6 total	



61. Locate **Front Horizontal Trim**. Position underneath roof Soffit and between Wide Vertical Trims. Attach with **4 - 1 1/2" Finishing Nails**

<u>Parts</u> Front Horizontal Trim (1/2" x 2 1/2" x 31 5/8)	<u>Hardware</u> 1 1/2" Finishing Nails x 4 total
--	---

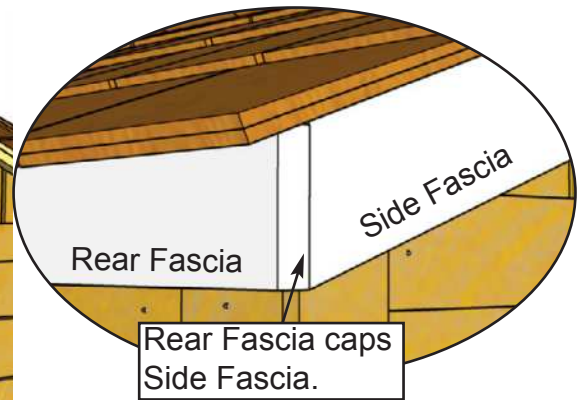
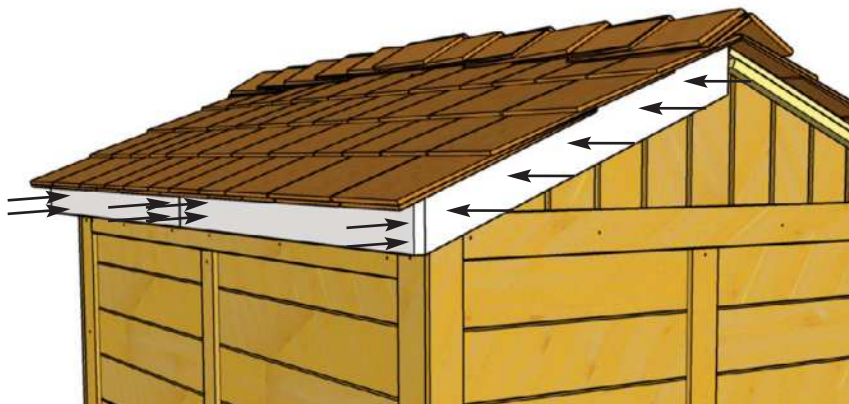

62. Position **Rear Fascia** (square cut ends) and **Side Fascia** (angle cut on ends) in corner. Line Fascia up so Rear Fascia caps Side Fascia. Attach Rear Fascia to ends of Rafters with **4 - 1 1/2" Finishing Nails** and Side Fascia to Nailing Strip with **5 - 1 1/2" Finishing Nails**. Gap where Fascia boards come together at peak will be covered in **Step 64**. Do a dry run using Side Fascia to help you correctly position before attaching.

<u>Parts (Steps 62 - 63)</u> Front & Rear Fascia (3/4" x 3 1/2" x 39 5/8") x 4 Side Fascia (Angle Cut Both Ends) (3/4" x 3 1/2" x 27 1/4") x 4	<u>Hardware (Steps 62 - 63)</u> 1 1/2" Finishing Nails x 36 total
--	---

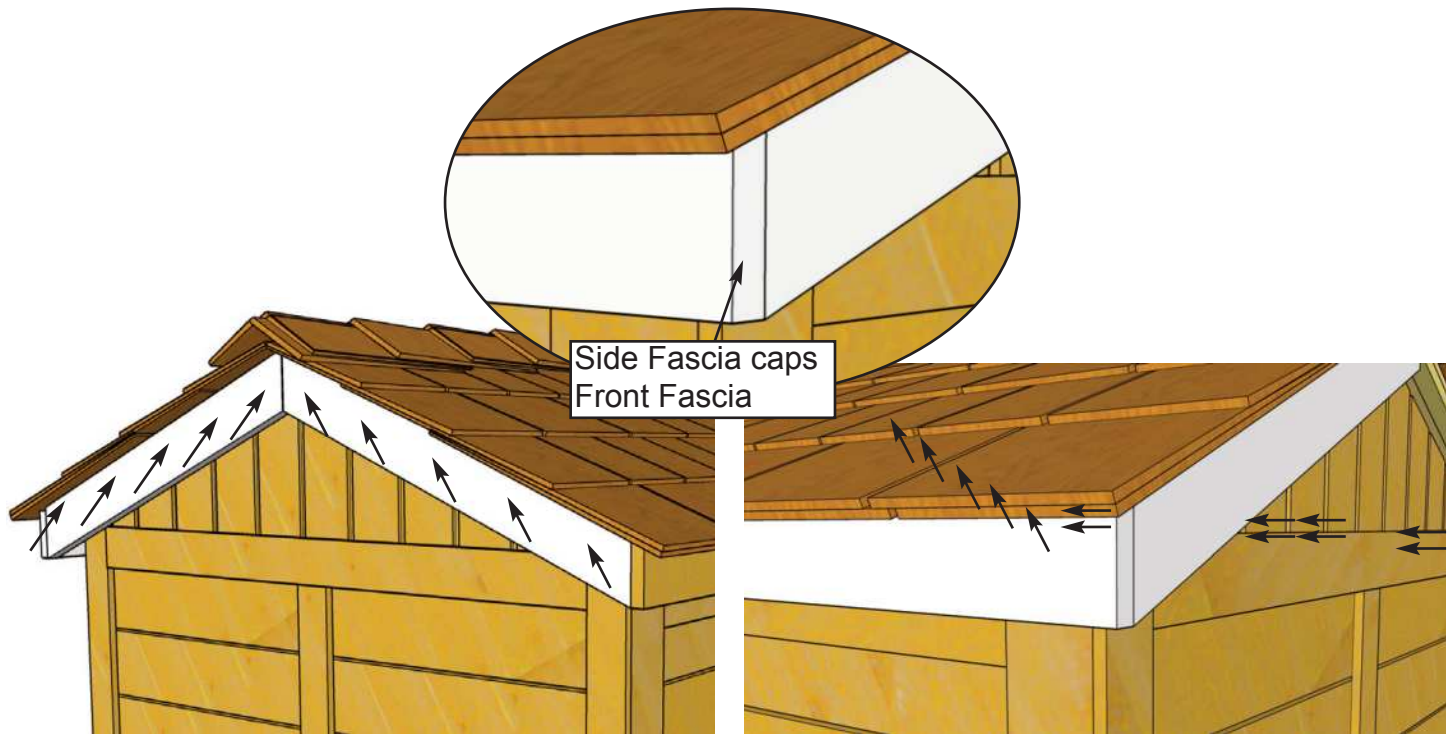

63. Attach remaining Side Fascia to Nailing Strips and attach remaining Front Fascia to Rafter ends as per **Step 62**.



64. Attach **Pentagon Detail Plates** where Side Fascia Trims meet at the peak. Secure with **4 - 1 1/2" Finishing Nails** per piece.

<p><u>Parts</u></p> <p>Pentagon Detail Plates (1/2" x 5" x 8") x 2</p>	<p><u>Hardware</u></p> <p>1 1/2" Finishing Nails x 8 total</p>
---	---

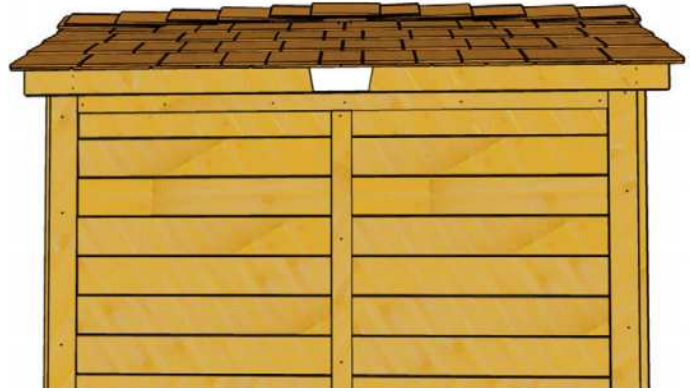
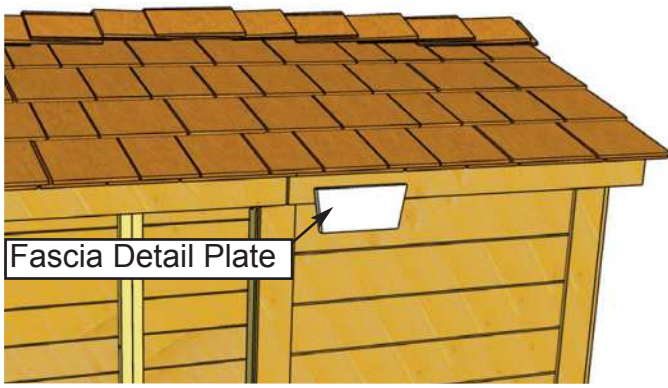

65. Attach **Fascia Detail Plates** where Front/Rear Fascia Trims meet in the middle.
Secure with **4 - 1 1/2" Finishing Nails** per piece.

Parts	Hardware
Fascia Detail Plates (1/2" x 3 1/2" x 8") x 2	1 1/2" Finishing Nails x 8 total

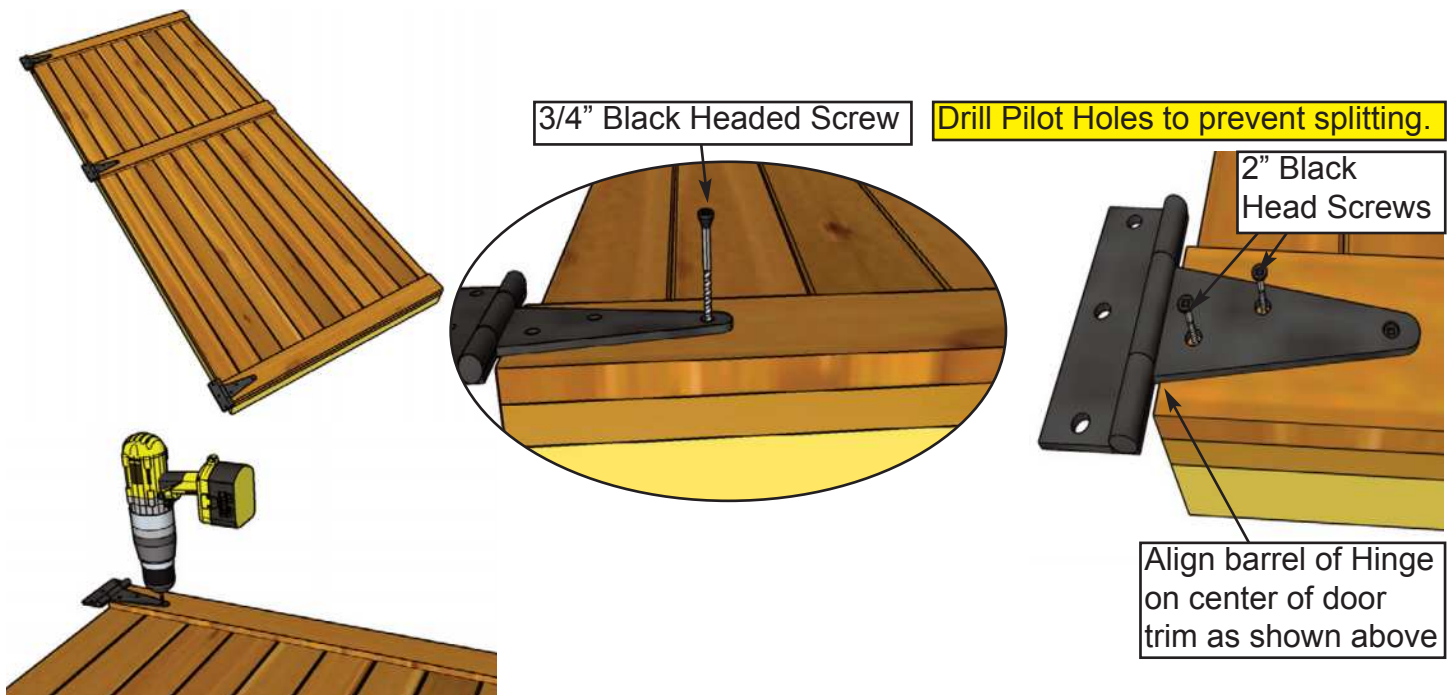

66. Locate **Solid Door and Black T Hinges**. Position Hinges equally on door trim as shown above and attach with **1 - 3/4" Black Headed Screw** and **2 - 2" Black Headed Screws** per Hinge.

Parts (Step 66 - 67)	Hardware (Step 66 - 67)
Solid Door (31 1/2" x 72")	Black T Hinge x 3 total 3/4" Black Headed Screws x 3 total 2" Black Headed Screws x 15 total

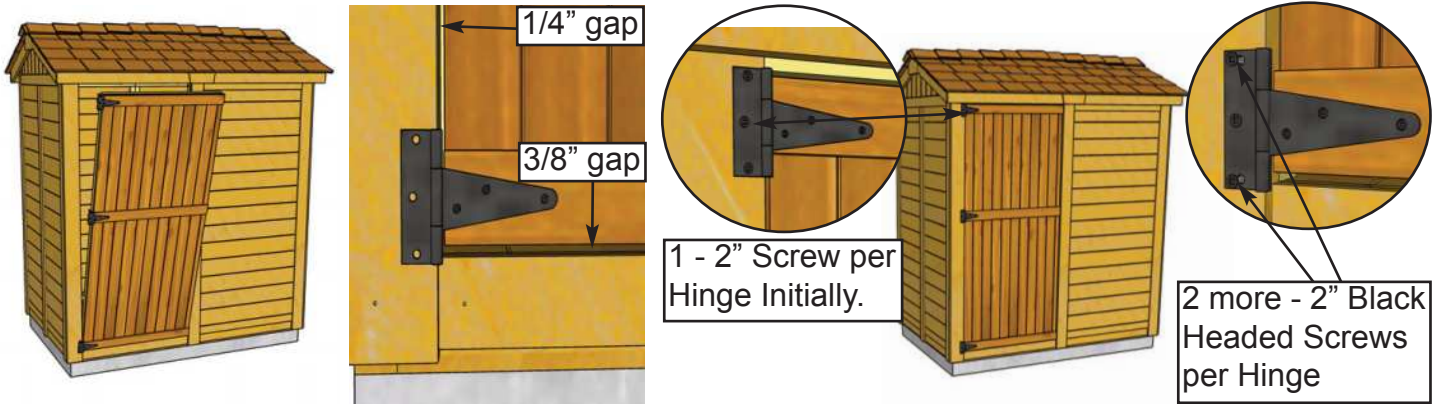

67. Lift and position Door in opening. Leave a 1/4" gap on left side and 3/8" gap on the bottom. Use a **Cedar Shingle Shim** to shim the Door at bottom to help position Door evenly. When Door is aligned correctly, screw Hinge into Vertical Door Frame Trim with **1 - 2" Black Headed Screw**. Use only 1 screw initially per Hinge until Door alignment is confirmed. With Door partially attached, check to see Door opens and closes correctly. Make any necessary adjustments and when satisfied, completely secure Hinges to Vertical Door Frame Trim with **two more 2" Black Headed Screws** per Hinge. Drill pilot holes to prevent wood from splitting.



68. Attach **Door Handle** to Doors with **4 - 3/4" Black Headed Screws**. Choose desired Handle height.

Hardware
Black Handle
3/4" Black Headed Screws x 4 total

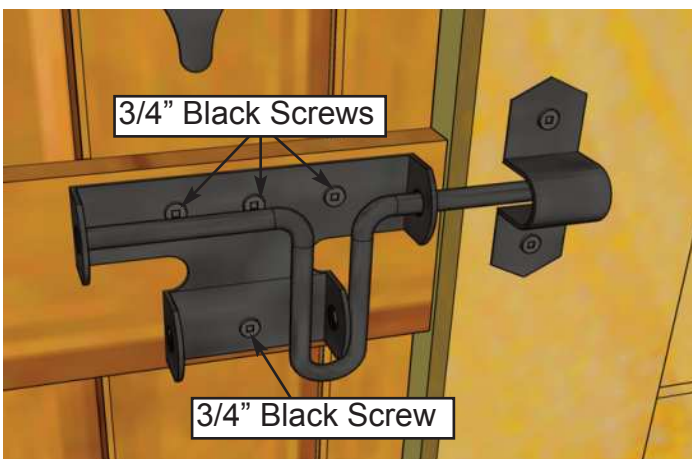

Important: Drill shallow Pilot Holes to prevent splitting.

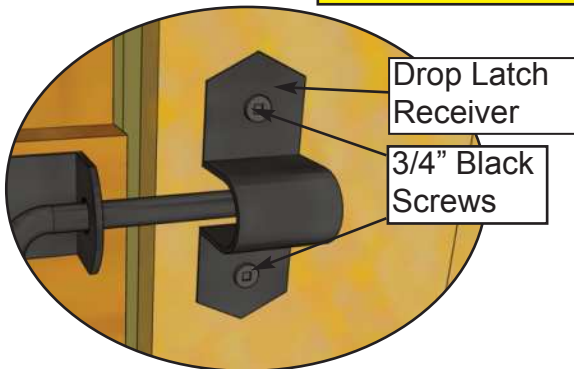

69. Attach **Black Drop Latch** as illustrated above with **6 - 3/4" Black Headed Screws**. **Note:** Black Drop Latch receiver is positioned higher than male. Do a dry run first to position Black Drop Latch correctly. **Important** - Drill pilot holes with 1/8" drill bit prior to securing with screws to prevent wood splitting.

Hardware
Black Drop Latch
3/4" Black Headed Screws x 6 total

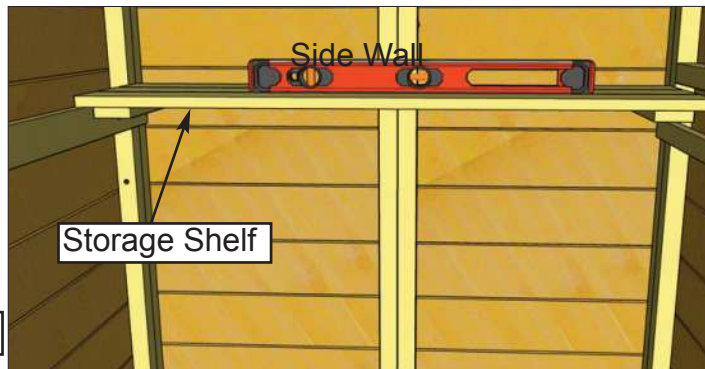
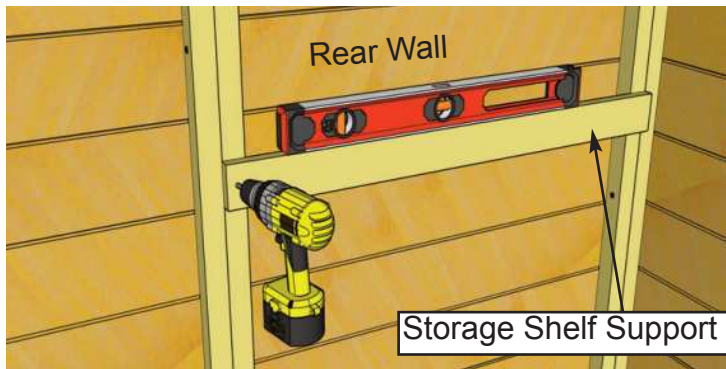

70. Storage Shelf positioning is flexible so decide what height configuration suits your needs. Gather your **Storage Shelf Supports**. The short Support (18 1/4") attaches to the Front Wall, the long (35") to the Rear Wall. Position using a Level, and drill Pilot Holes to prevent ends of Supports from splitting. Attach first Support using **2 - 1 1/4" Brown Screws**. Place **Storage Shelf** on attached Support, Level, and mark position of second Support. Pilot Hole and secure second Support.

<p><u>Parts (Steps 70 - 71)</u> Storage Shelf Supports (3/4" x 2 1/2" x 35") x 4 Storage Shelves (11 1/2" x 41 7/8") x 2</p>	<p><u>Hardware Parts (Steps 70 - 71)</u> 1 1/4" Brown Screws x 8 total 1 1/2" Finishing Nails x 8 total</p>
--	---

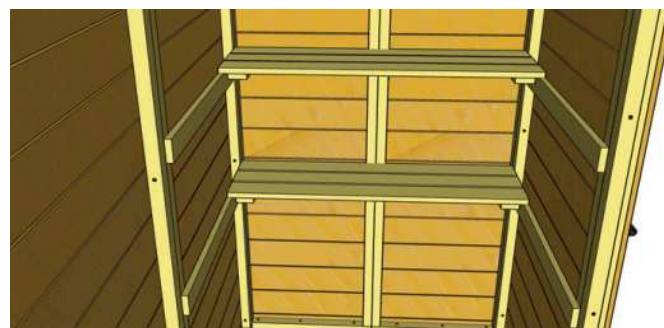

71. Place **Storage Shelf** on top of supports and secure with **4 - 1 1/2" Finishing Nails**. Complete second Shelf (if desired) as per **Steps 70 & 71**.



Note: Our Sheds are shipped as an unfinished product. If exposed to the elements, the lumber will weather to a silvery-gray color. If you prefer to keep the lumber looking closer to the original color, we suggest that you treat the wood with a good oil base wood stain. You may also wish to paint your new shed rather than stain it. In both cases we recommend that you consult with a paint and stain dealer in your area for their recommendations.

Congratulations on assembling your 6x4 Maximzer!

We hope your experience constructing our **6x4 Maximzer** has been both positive and rewarding. We value your feedback and would like to hear back from you on how well we are doing in the following areas:

- 1. Customer Service**
- 2. On Time Shipping**
- 3. Motor Freight Delivery**
- 4. Quality of Materials**
- 5. Assembly Manual**
- 6. Overall Satisfaction**



The materials contained in this Assembly Manual may be downloaded or copied provided that ALL copies retain the copyright and any other proprietary notices contained on the materials. No material may be modified, edited or taken out of context such that its use creates a false or misleading statement or impression as to the positions, statements or actions.

Please call, write or email us at:

Canadian Address
9393 287th Street
Maple Ridge, British Columbia
Canada V2W 1L1

United States Address
P.O. Box 96
Sumas, Washington
USA 98295

Toll Line: 1.888.658.1658 | Fax: 1.604.462.5333 | sales@outdoorlivingtoday.com