

Garden Chalet 4X2 - Bevel Assembly Manual

Thank you for purchasing a 4x2 Garden Chalet. Please take the time to identify all the parts prior to assembly.

Please use Safety Eyewear and Gloves while assembling. Be sure to read and follow all operating instructions for any tools used during assembly. Remember - NO SAW CUTTING IS REQUIRED!

Safety Points and Other Considerations

Our products are built for use based on proper installation and normal residential use, on level ground. Please follow the instruction manual when building your Garden Chalet and retain the manual for future maintenance purposes.

Some of the safety and usage measures you may wish to consider include:

-If the product is elevated, any structural and building code requirements are solely the customer's responsibility, and should be abided by.

-In high or gusty wind conditions it is advisable to keep the structure securely grounded.

-Have a regular maintenance plan to ensure screws, doors, roof and parts are tight.



4x2 Garden Chalet Dimensions:

- A: Outside Height (Rear) = 73"
- B: Outside Height (Front) = 68"
- C: Outside Width = 49 1/4"
- D: Outside Depth = 22 1/2"
- E: Door Width = 40"
- F: Door Height = 61 3/8"
- G: Inside Height (Rear) = 65 1/8"
- H: Inside Height (Front) = 62"
- I: Inside Width = 44"
- J: Inside Depth = 18 1/2"

In the event of a missing or broken piece, simply call the Outdoor Living Today Customer Support Line @ 1-888-658-1658 within 30 days of the delivery of your purchase. It is our commitment to you to courier replacement parts, free of charge, within 10 business days of this notification. Replacement parts will not be provided free of charge after the 30 day grace period.

Exploded View and Parts List for 4'x2' Garden Chalet - BEVEL

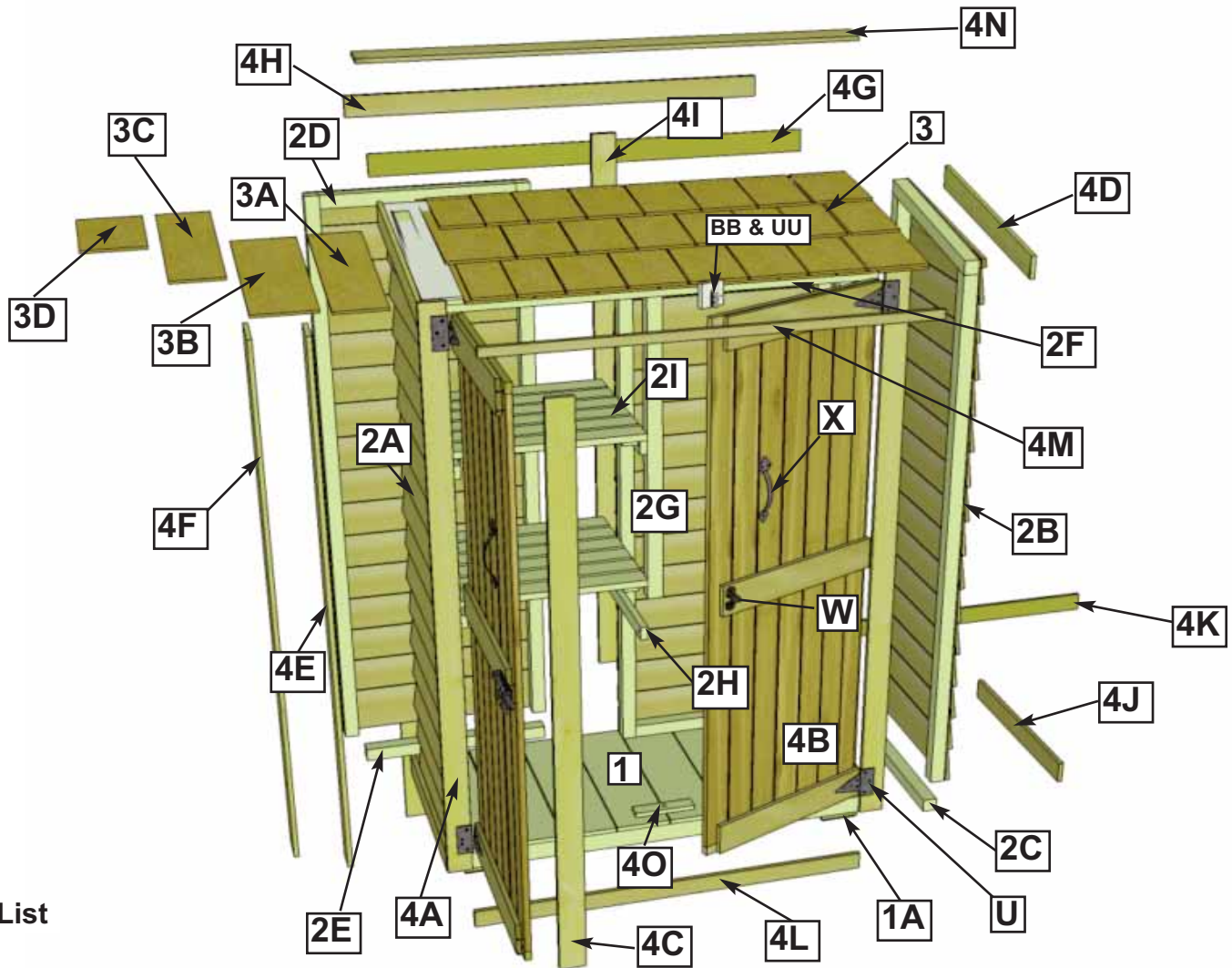

Parts List

Floor Section

- 1 1 - Floor Section - 20 5/8" x 45 1/4" x 2 1/2"
- 1A 4 - Floor Legs - 1 1/2" x 3 1/2" x 4"

Wall Section

- 2A 1 - Left Angled Side Wall - 18 1/2" x 67"
- 2B 1 - Right Angled Side Wall - 18 1/2" x 67"
- 2C 2 - Bottom Plates for Angled Side Walls - 1 1/2 x 1 1/2" x 15 1/2"
- 2D 2 - Rear Walls - 22 5/8" x 67"
- 2E 2 - Bottom Plates for Rear Walls - 1 1/2 x 1 1/2" x 19 5/8"
- 2F 1 - Door Header - 1 1/2" x 2 1/2" x 41" - Dado Cut
- 2G 1 - Vertical Shelf Support - 1 1/2" x 1 1/2" x 35"
- 2H 4 - Shelf Supports - 1 1/2" x 1 1/2" x 17 3/4"
- 2I 2 - Shelves - 16 3/4" Deep x 18 3/4" Wide

Roof Section

- 3 1 - Shingled Roof Panel (side shingles to install) - 23"d x 45 1/4"w
- 3A 3 - 16" long x 5" wide Shingles (includes 1 extra)
- 3B 3 - 16" long x 6" wide Shingles (includes 1 extra)
- 3C 3 - 15" long x 5" wide Shingles (includes 1 extra)
- 3D 2 - 7" long x 6" wide Last Row Shingles

Trim Section

- 4A 2 - Front Corner Door Trims - 1/2" x 2 1/2" x 65 1/4"
- 4B 2 - Doors - 20 1/4" x 61 3/8"
- 4C 1 - Door Flange - 1/2" x 2 1/2" x 61 3/8"
- 4D 2 - Side Facia Trims - 1/2" x 2 1/2" x 21 3/4" - angle cut ends
- 4E 2 - Side / Front Corner Trim - 1/2" x 2 1/2" x 61" - angle cut end
- 4F 2 - Side / Rear Corner Trim - 1/2" x 3 1/2" x 65 1/2" - angle cut
- 4G 1 - Upper Rear Hor. Filler Trim (Bevel) - 1/2" x 2 1/2" x 45 1/2"
- 4H 1 - Upper Rear Hor.Trim - 1/2" x 2 1/2" x 45 1/2"
- 4I 3 - Rear Corner (2) & Center (1) Trim - 1/2" x 2 1/2" x 65 1/2"
- 4J 2 - Bottom Side Skirting - 1/2" x 2 1/2" x 21 1/8"
- 4K 1 - Bottom Rear Skirting - 1/2" x 2 1/2" x 45 1/4"
- 4L 1 - Front Bottom Skirting - 1/2" x 2 1/2" x 41 1/4"
- 4M 1 - Front Door Header Trim - 1/2" x 1" x 41 1/4"
- 4N 1 - Roof Ridge Cap - 1/2" x 3 1/2" x 49 1/4"
- 4O 1 - Lower Door Stop - 3/4" x 1 1/2" x 8"

** Plus 2 Cedar Shingle Shims (4P) discard after shimming doors

Note: We recommend you drill a 1/8" pilot hole for each screw, to avoid splitting wood. The hole depth should be equal to 3/4 the length of screw.

Note: All Trim and Skirting pieces are graded best face rough. This means the rough side will be exposed when completing these Sections.

4x2 GARDEN CHALET - BEVEL

Hardware Kit (Provided)

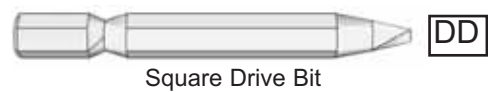

(U) Tee Hinge
x 4 pcs.



(X) Door Handle
x 2 pcs.



(W) Barrel Bolt



(BB) Silver
Barrel Bolt



(UU) 1/2"x 2 3/4"
Plywood Spacer

Tools Required (Not Provided)



Hammer



Screw Gun/Drill



Tape Measure



Wood Clamp



3/8" Wrench



Level



Pliers



Ladder



1/8" & 3/8" Drill Bit

Safety Equipment Required (Not Provided)



Safety Glasses



Work Gloves

You can find the Square Drive Bit (DD) for the screws in the Hardware Kit Bag.

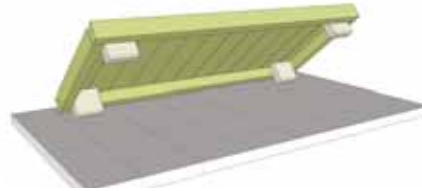
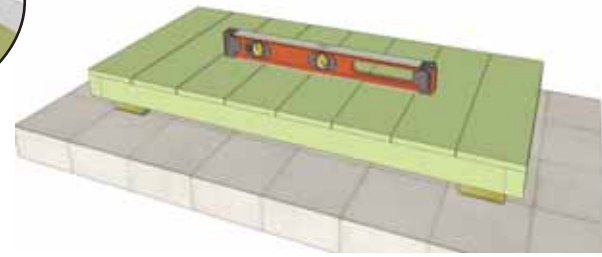
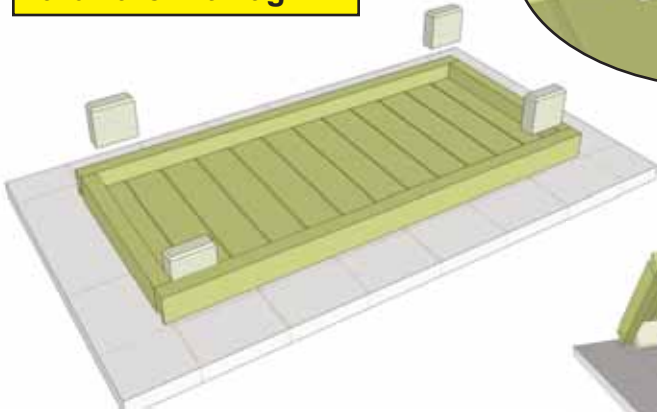
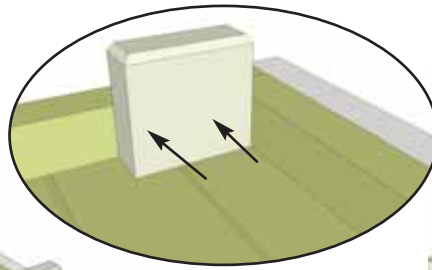

1. Flip Floor (1) over on a level surface. Locate Legs (1A) and position in each corner tight to floor and framing and attach with 2 - 2 1/2" Screws (C). Complete all leg attachments. Level floor before proceeding to Step 2.

You can find the Square Drive Bit (DD) for the screws in the Hardware Kit Bag.

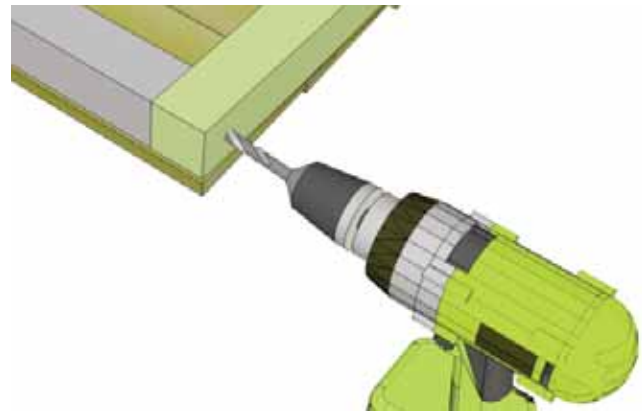
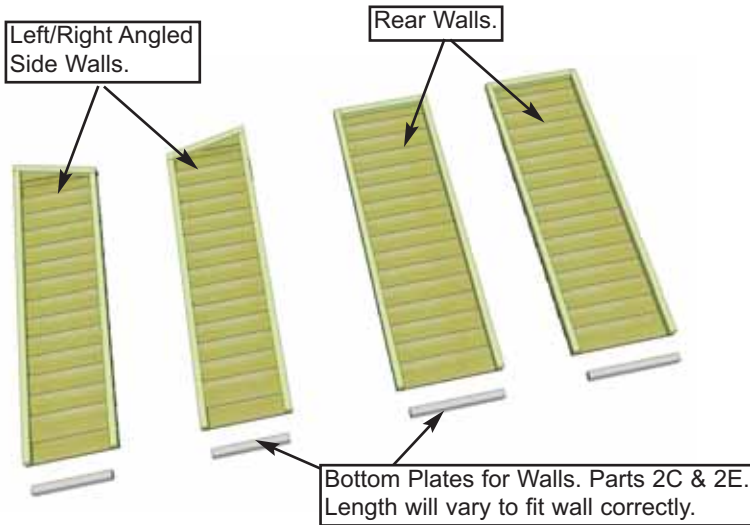

2. Locate 2 - Bottom Plates for Angled Walls (2C) - 1 1/2" x 1 1/2" x 15 1/2" and 2 - Bottom Plates for Rear Walls (2E) - 1 1/2" x 1 1/2" x 19 5/8". Position plates flush to bottom of wall framing. Pre-drill wall framing approximately 3/4" from end with 1/8" drill bit to prevent wood from splitting.

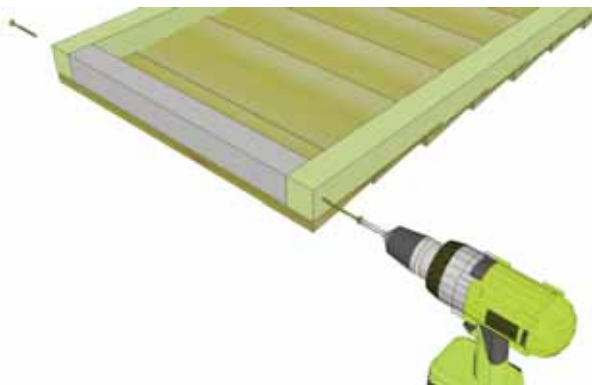

3. With bottom plate aligned flush with wall framing, attach with 1 - 2 1/2" Screw (C) per side.

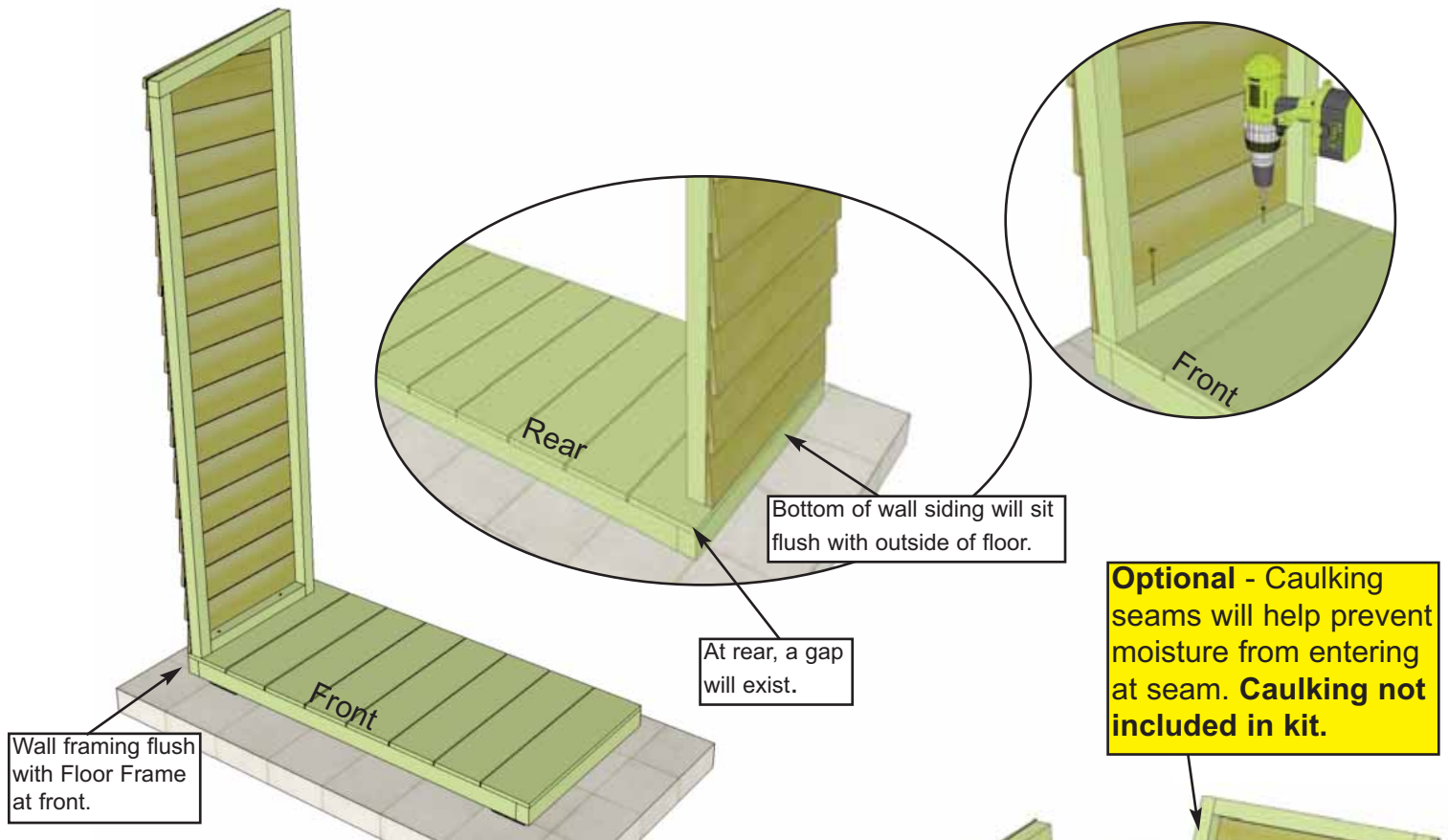

4. Locate Left Angled Side Wall (2A). Position on floor as illustrated above. Have helper hold wall while wall is screwed down to floor with **2 - 2 1/2" Screws (C)**
Important - confirm alignment before attaching.

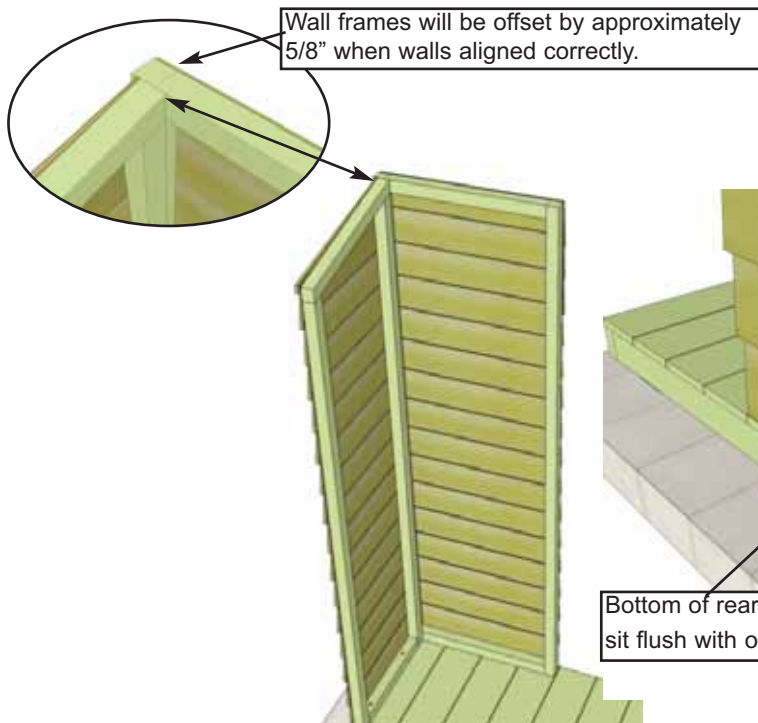

5. Align Rear Wall (2D) flush to floor at the back. Wall frames will be offset by approximately 5/8" when walls aligned correctly. **Optional - Caulking** wall seams will help prevent moisture from entering at seam. **Caulking not included in Kit.**

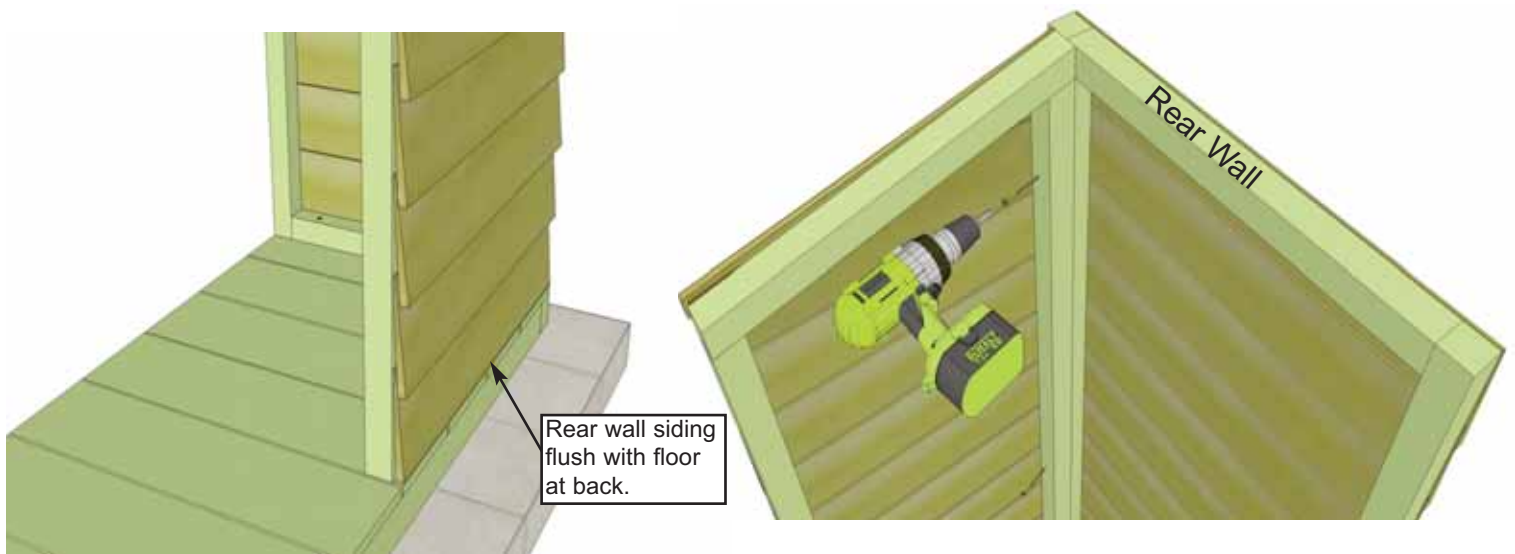

Rear wall siding flush with floor at back.

Rear Wall

6. With side and rear walls correctly positioned, attach together at top, middle and bottom of vertical wall frames with **3 - 2 1/2" Screws (C)**.

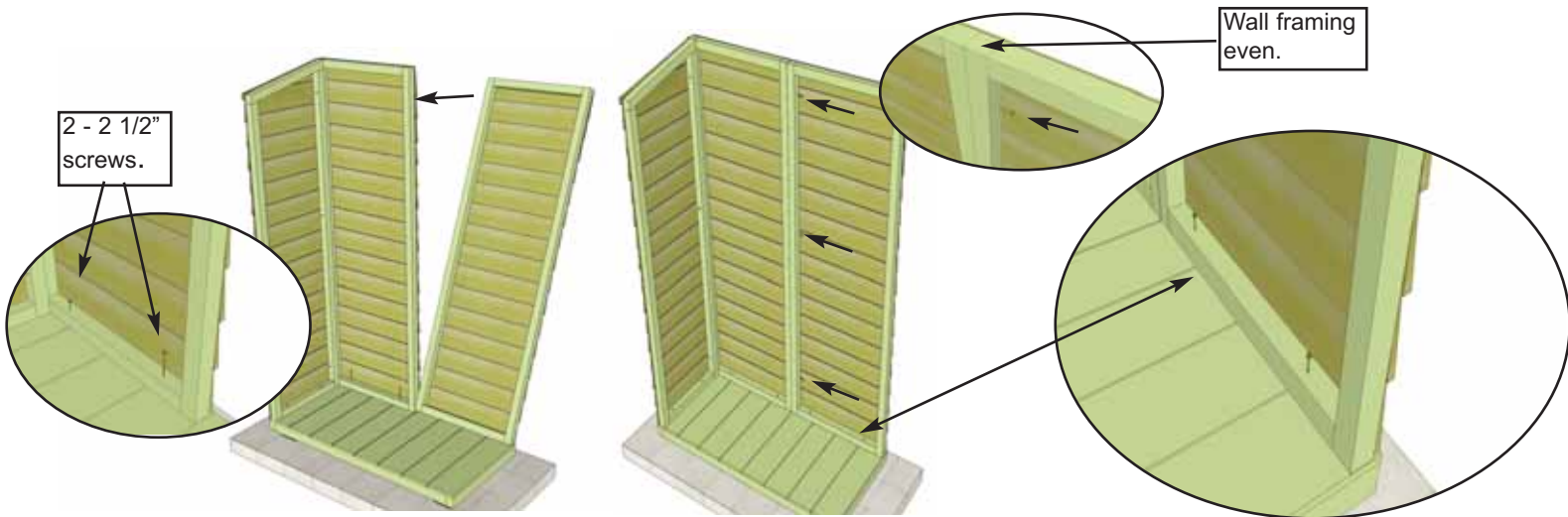

2 - 2 1/2" screws.

Wall framing even.

7. Have helper hold wall in place while screwing down to floor with **2 - 2 1/2" Screws (C)**
Important - Confirm alignment before attaching.

Position **2nd Rear Wall (2D)** on floor as per **Step 5 & 6**. Attach wall frames together at top, middle and bottom with **3 - 2 1/2" Screws (C)**. Screw second rear wall down to floor with **2 - 2 1/2" Screws (C)** when aligned correctly. Caulking wall seam is an option once again.

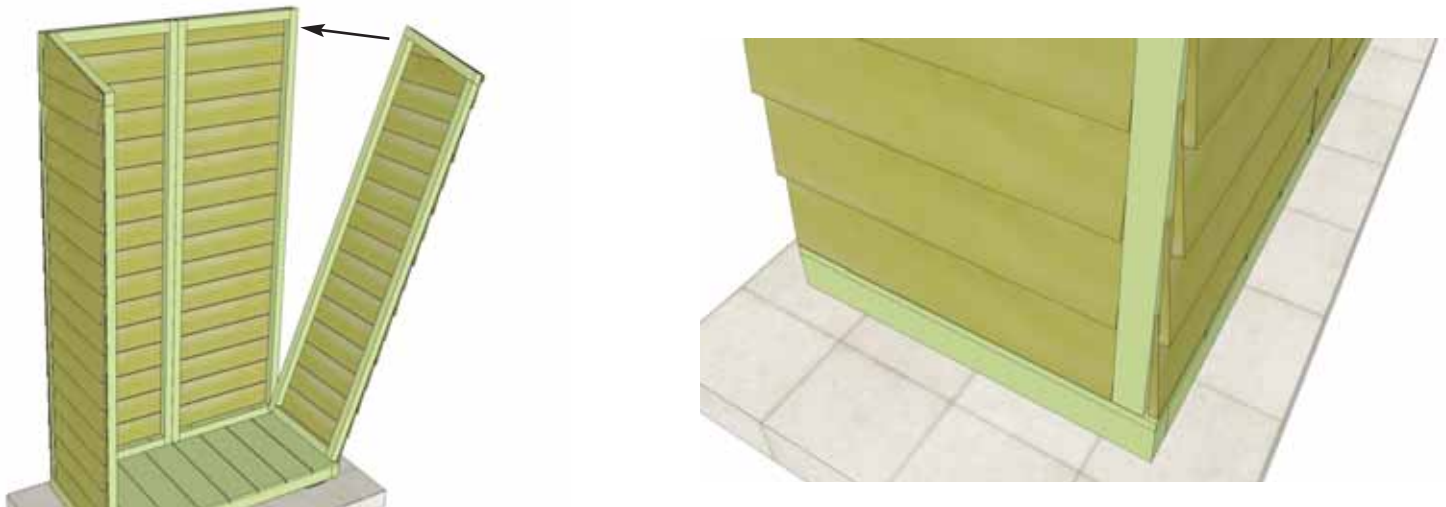

8. Position **Right Angled Side Wall (2B)** on floor and against rear wall as per **Steps 4 - 5**.

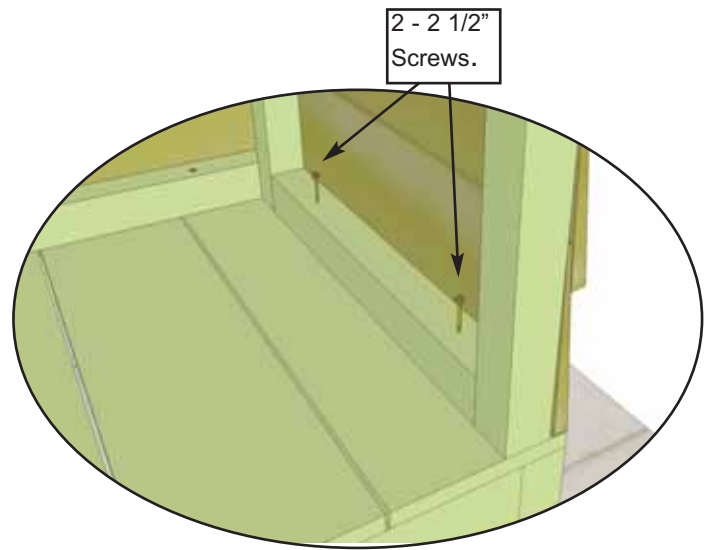
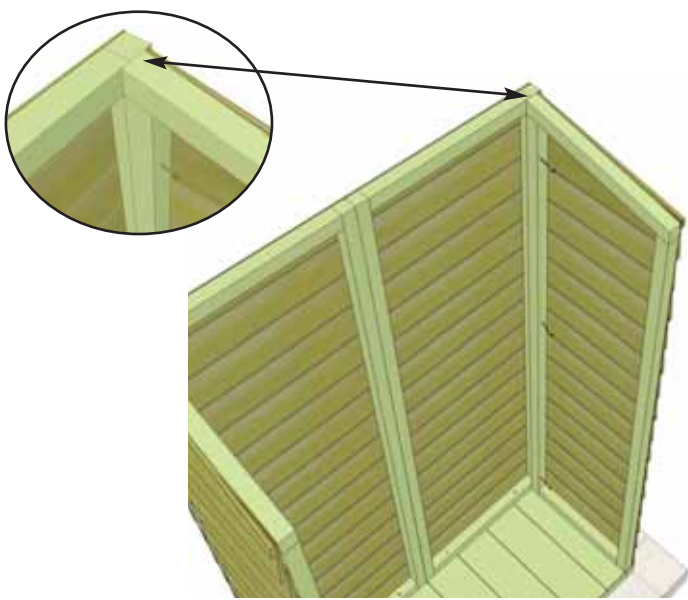

9. With Right Angled Side Wall correctly aligned to floor and rear wall framing, attach rear and side walls together at top, middle and bottom of vertical wall frames with **3 - 2 1/2" Screws (C)**. Screw wall plate to floor with **2 - 2 1/2" Screws (C)** when correctly aligned.



Optional - Caulking seams where wall and floor meet will help prevent moisture from entering at seam. **Caulking not included in kit.**

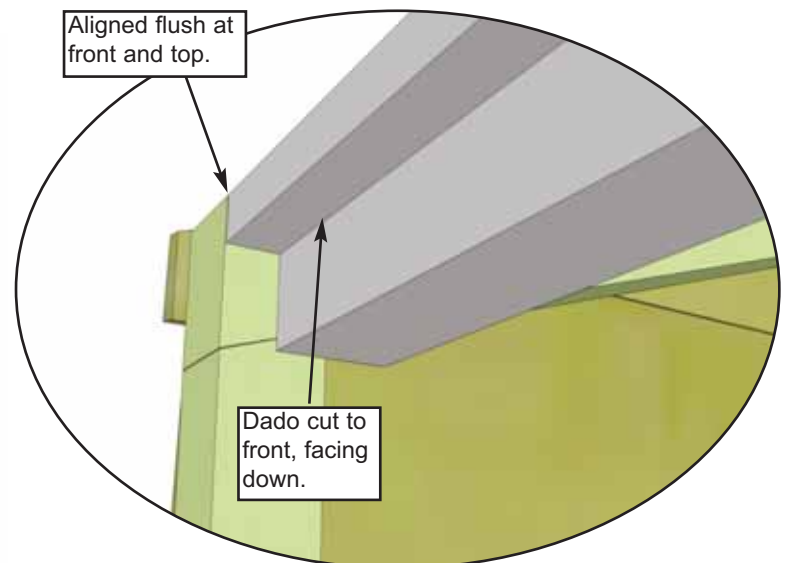
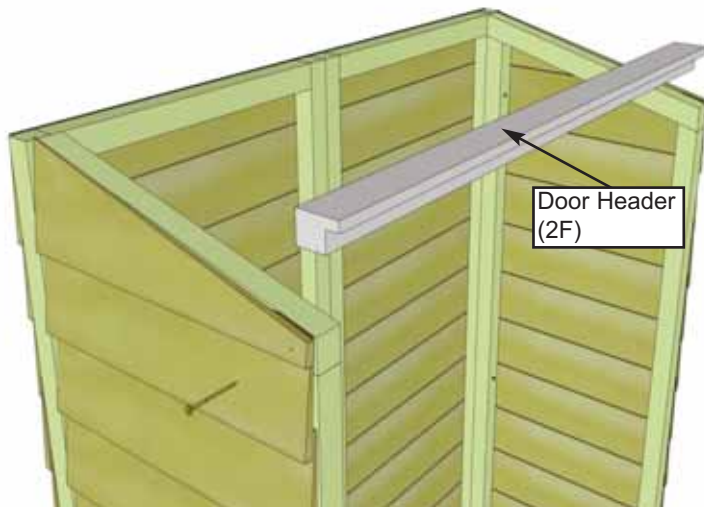

10. Locate **Door Header (2F) - 1 1/2" x 2 1/2" x 41"** (dado cut) and place between side wall framing with dado cut facing down and to the front.

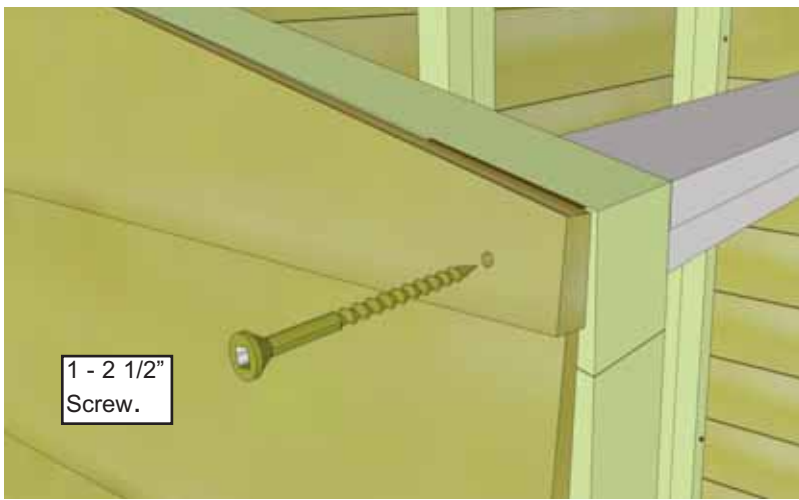

11. Side walls are pre-drilled at top front. Before attaching header to side walls, have your helper hold header and wall steady. Secure with **2 - 2 1/2" Screws (C)** per side.

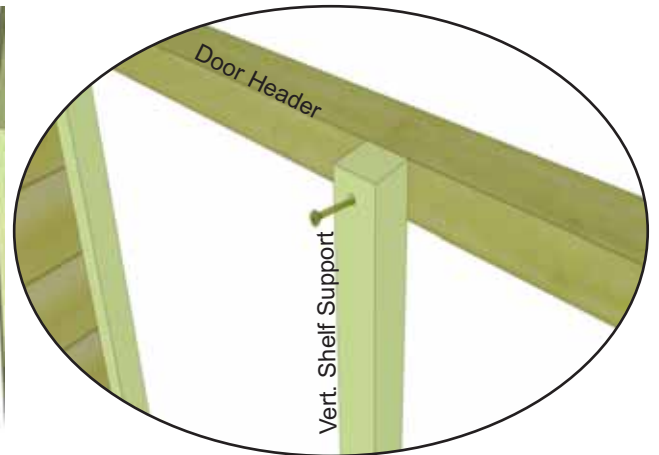
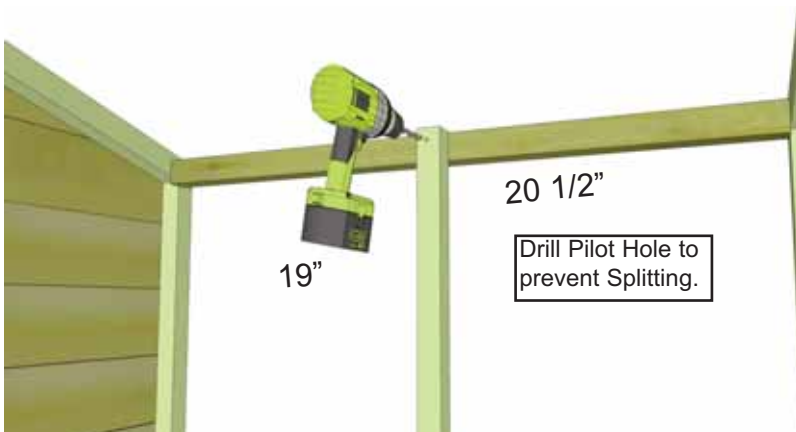

12. Shelving may be mounted on left or right side of Chalet. This manual illustrates the shelving being mounted on the left side. First, locate the **Vertical Shelf Support (2G) 1 1/2" x 1 1/2" x 35"**. Measure 19" from left side wall framing from the inside. Mark position on door header. Drill pilot hole near end of shelf support to prevent splitting and attach to door header with **1 - 2 1/2" Screw (C)**.

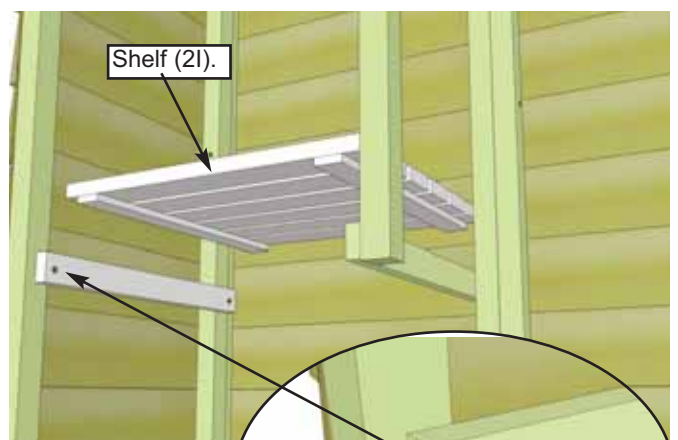
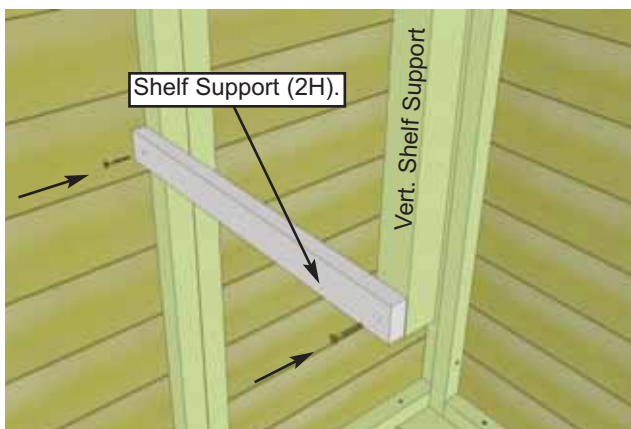

13. Locate 1 **Shelf Support (2H) - 1 1/2" x 1 1/2" x 17 3/4"** and position on vertical shelf support and rear wall framing. Drill pilot hole in support to prevent splitting and attach with **1 - 1 1/4" Screw (E)** on each end.

Note - Make sure shelf support is level prior to attaching. Attach second Shelf Support to side wall framing as described and shown to the right. Place **Shelf (2I)** on top of shelf supports.

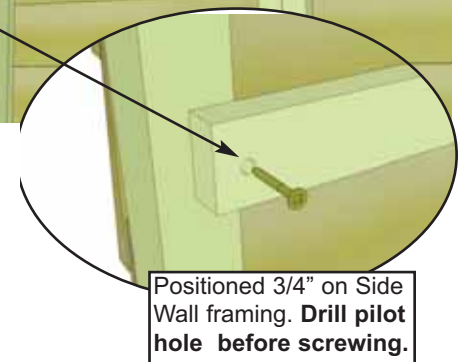

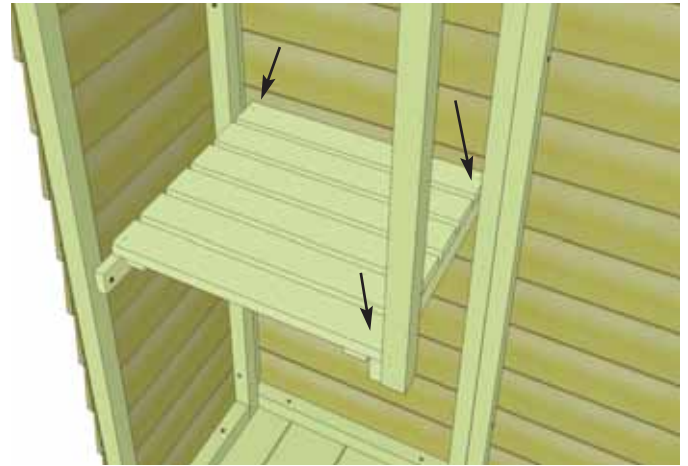
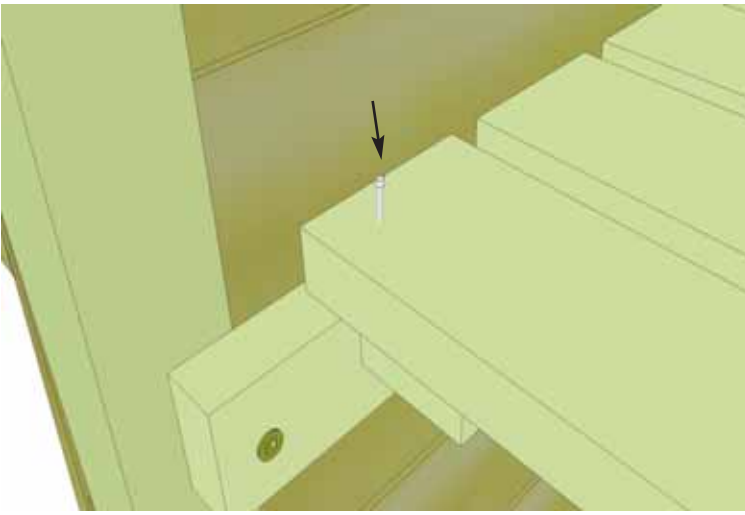

14. Secure shelf to shelf supports with 4 - 1 1/2" Finishing Nails (K)

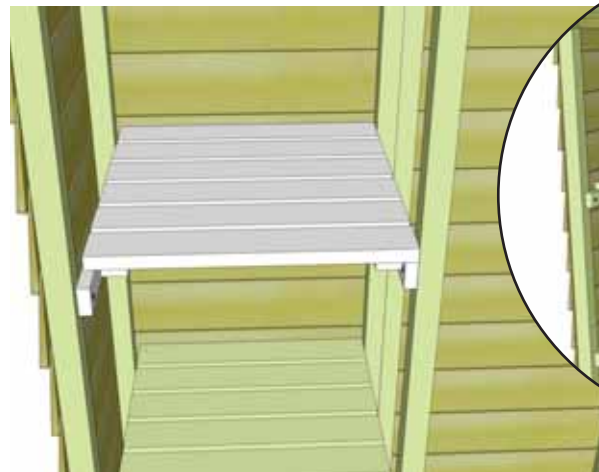

15. Complete positioning and attachment of second shelf as per **Step 13 - 14.**

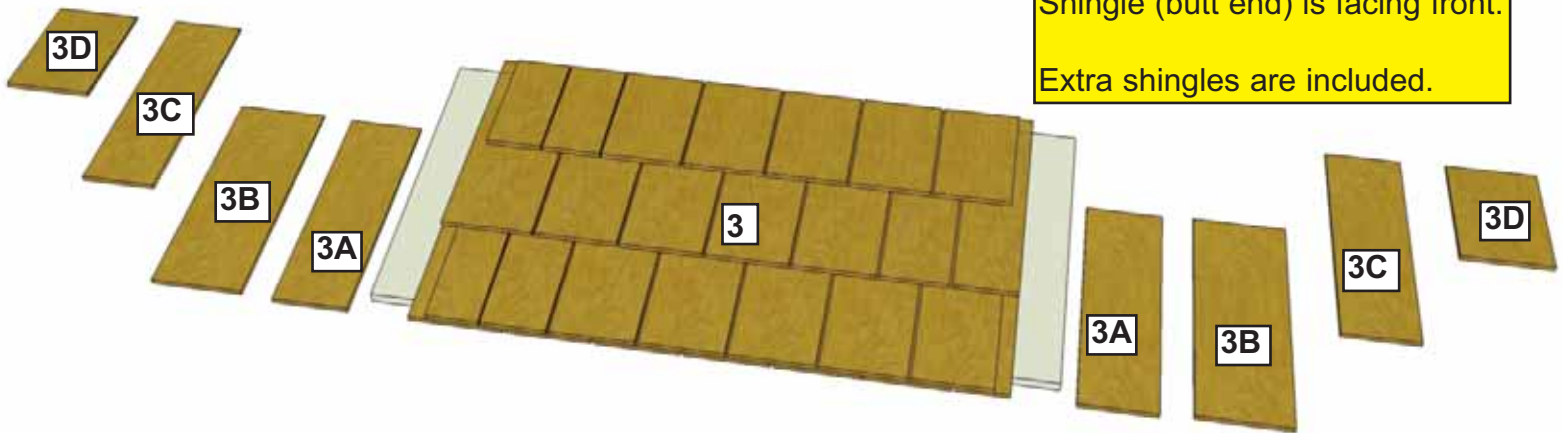

Align Roof Panel so thick end of Shingle (butt end) is facing front.
Extra shingles are included.

16. Lay **Roof Panel (3)** on flat level ground. Note, overhanging Outside Shingles have been removed to avoid shipping damage and will need to be installed now. Locate **3A ,3B, 3C & 3D Shingles**. There are 3 - 5" wide x 16" long **3A Shingles**, 3 - 6" wide x 16" long **3B Shingles**, 3 - 5" wide x 15" long **3C Shingles** and 2 - 6" wide x 7" long **3D Shingles**.

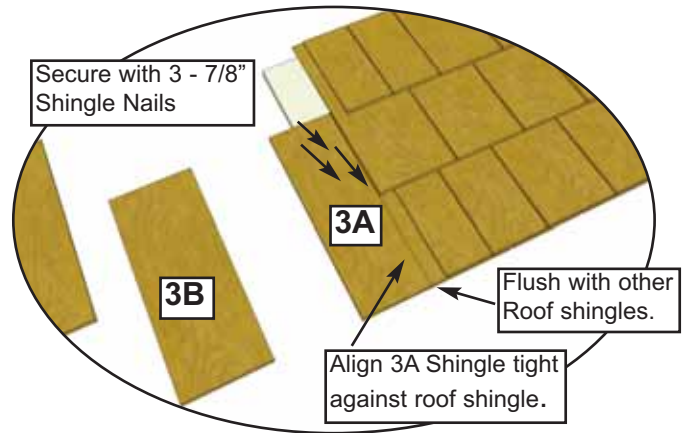
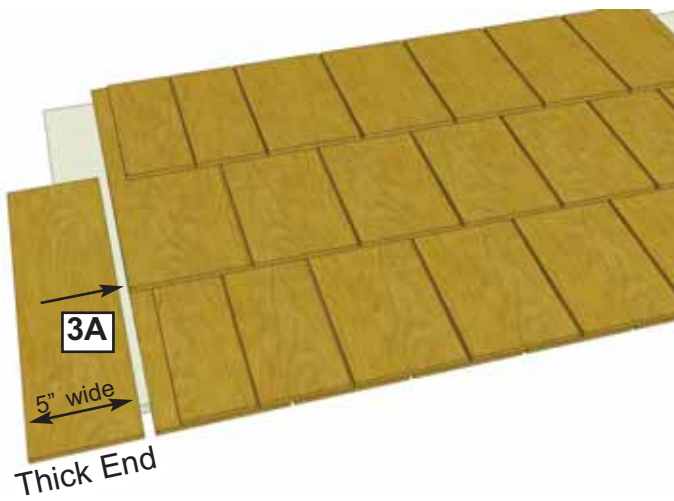

17. Position and attach 3A Shingle (5" wide) on Roof Panel with **3 - 7/8" Shingle Nails (M)**. See above for details.

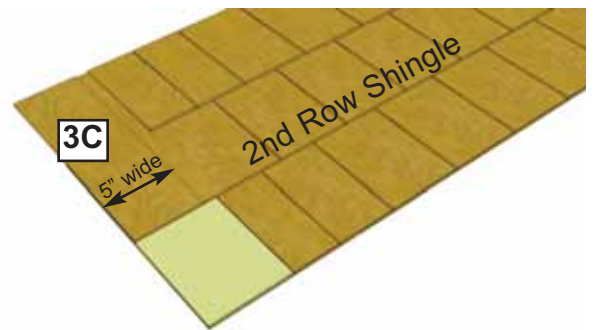
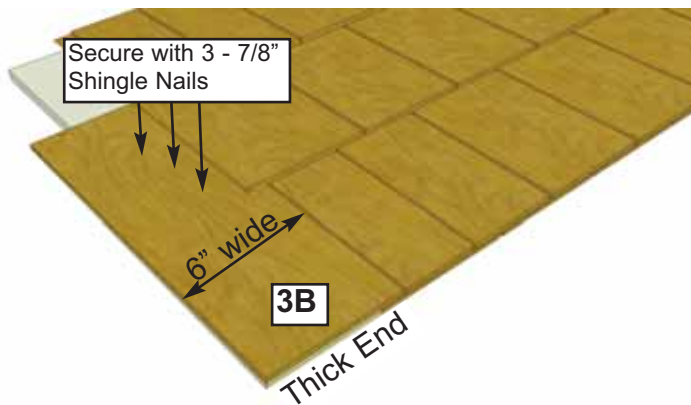

18. Place and attach 3B Shingle (6" wide) directly on top of Shingle 3A. Shingle 3B will slide under 2nd row shingle. Secure with **3 - 7/8" Shingle Nails (M)** at least 9" from butt. Place and attach a 3C Shingle (5" wide x 15" long) in line with second row of shingles. Secure with **3 - 7/8" Shingle Nails (M)** at least 9" from Butt.

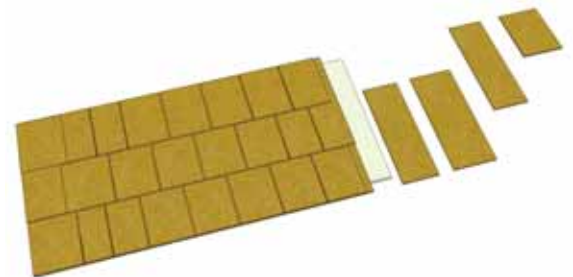
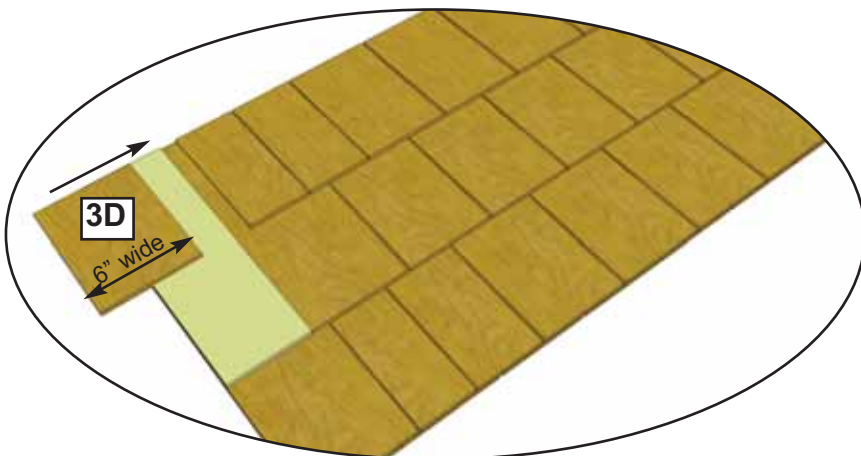

19. To finish side, place and attach 3D Shingle (6" wide x 7" long) in line with 3rd and final row of shingles. Shingle 3D will partially cover Shingle 3C. Secure with **2 - 7/8" Shingle Nails (M)** 2" - 3" from top. (Nails will be covered by Ridge Cap - 4N). Complete attachment of shingles on opposite roof panel side following **Steps 17 - 18**.

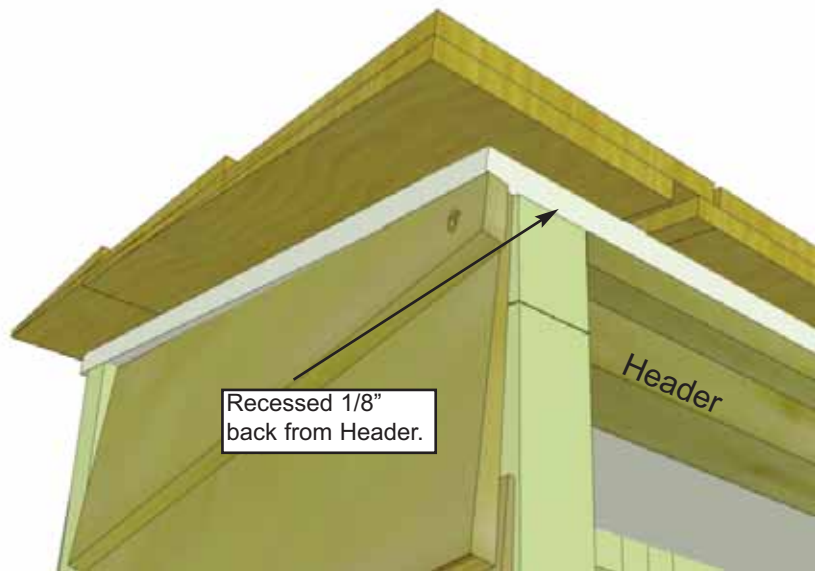
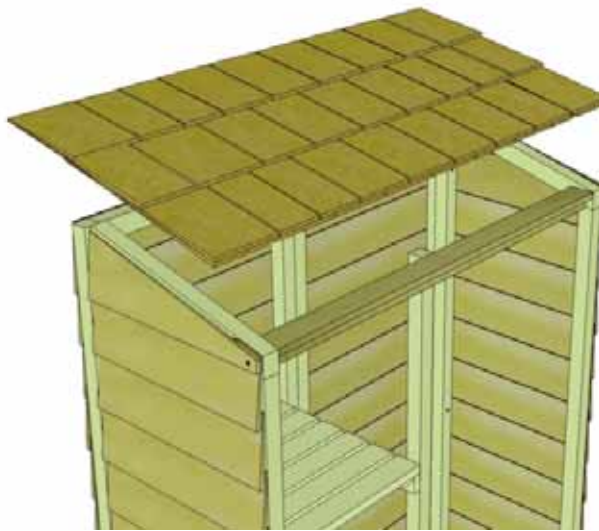

20. Carefully lift and place completed **Shingle Roof Panel (3)** on wall framing and door header. At the front, recess the plywood sheathing of the roof slightly back 1/8".

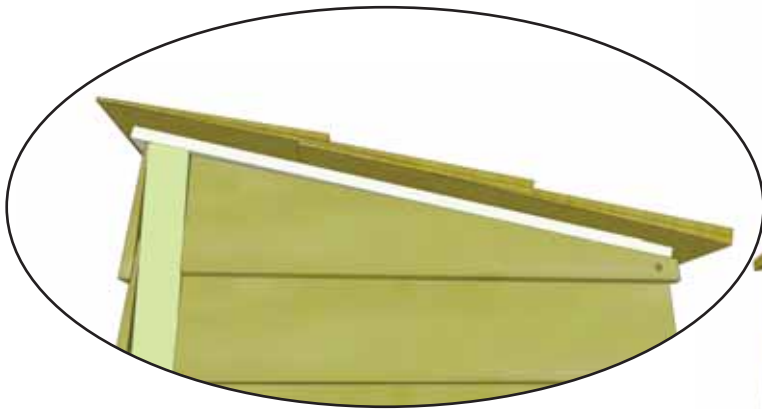

21. Align plywood sheathing of the roof evenly from side to side as illustrated above.



22. From inside the chalet, secure roof to wall framing and door header. You will need to use **8 - 2" Screws (D)** for the sides and rear and **4 - 2 1/2" Screws (C)** angled from the header into the roof sheathing for the front header section.

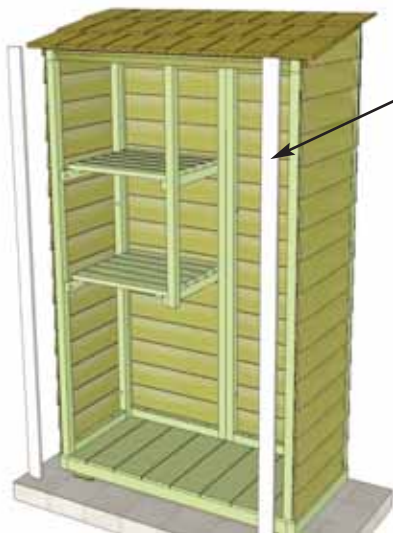

Front Corner Door Trims (4A)

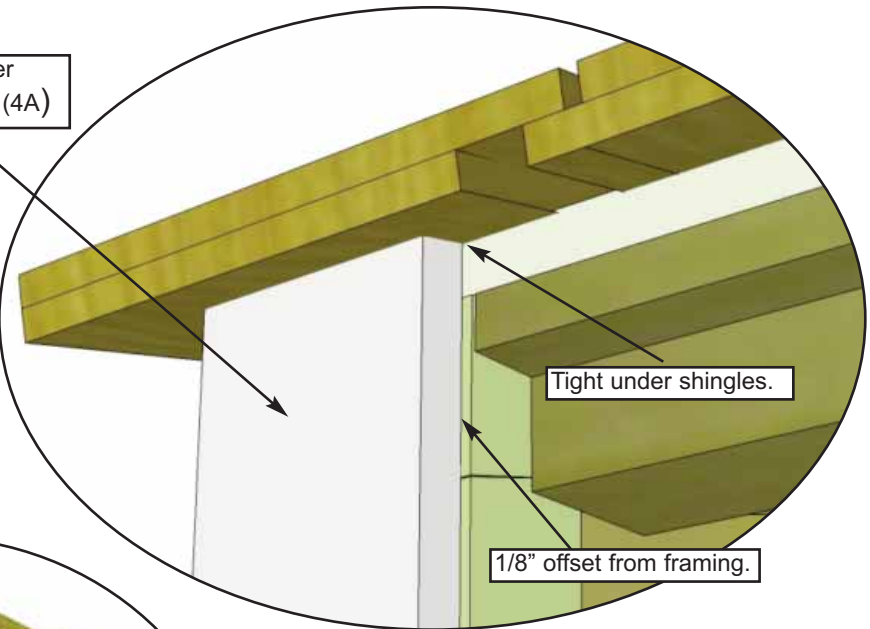

Tight under shingles.

1/8" offset from framing.

Note: All Trim and Skirting pieces are graded best face rough. This means the rough side will be exposed when completing these sections.

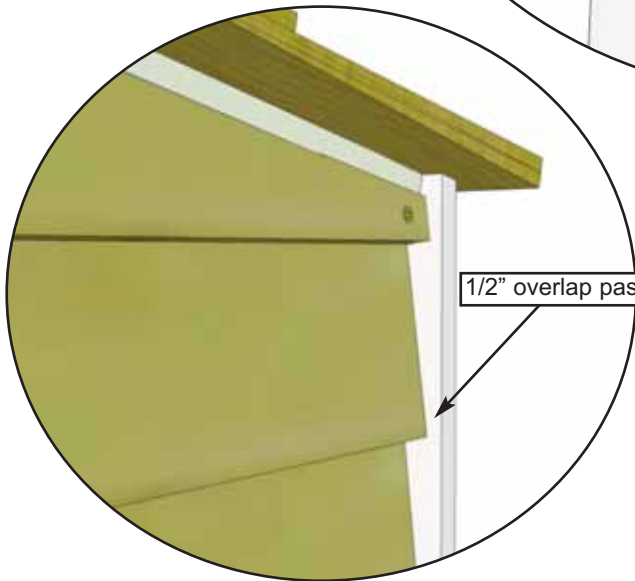

1/2" overlap past siding butt.

23. Locate **Front Corner Door Trims (4A)** - 1/2" x 2 1/2" x 65 1/4" - 2 pcs. Position tight underneath roof shingles and against side wall framing. Align trim so there is 1/8" offset on wall framing. From the outside, the trim should overlap the thickest part of the wall siding by 1/2". See **Step 29** for corner trim alignment. Do a dry run with both front and side corner trims (**Parts 4A & 4E**) to confirm proper positioning before attaching front trim. At the bottom, trim will align with bottom of floor.

Attach with **6 - 1 1/2" Finishing Nails (K)** per trim. Complete both sides.

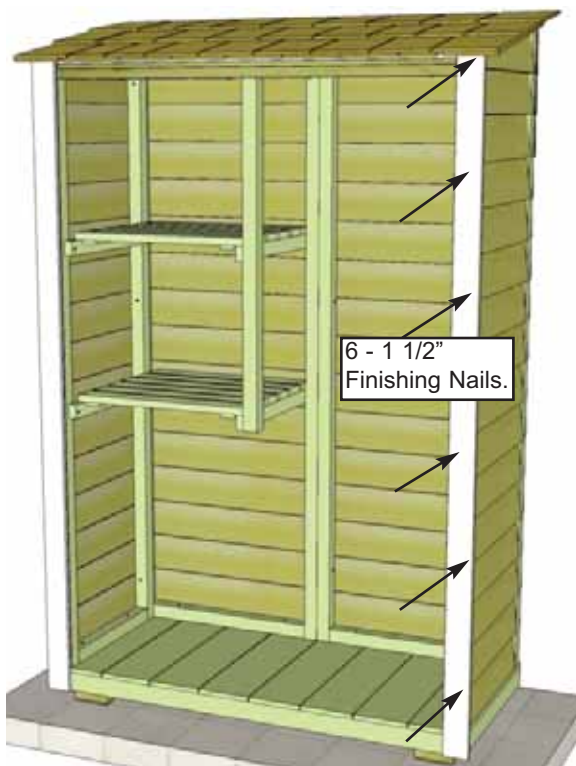

6 - 1 1/2" Finishing Nails.

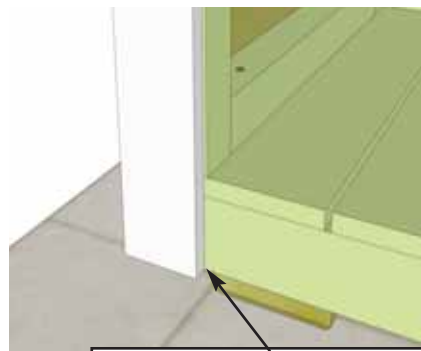

Trim flush with bottom of floor.

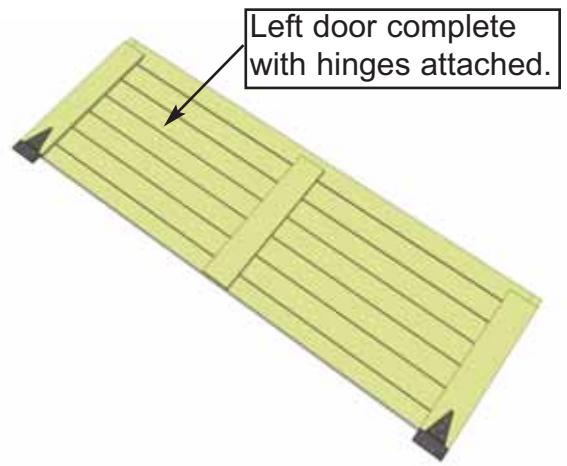
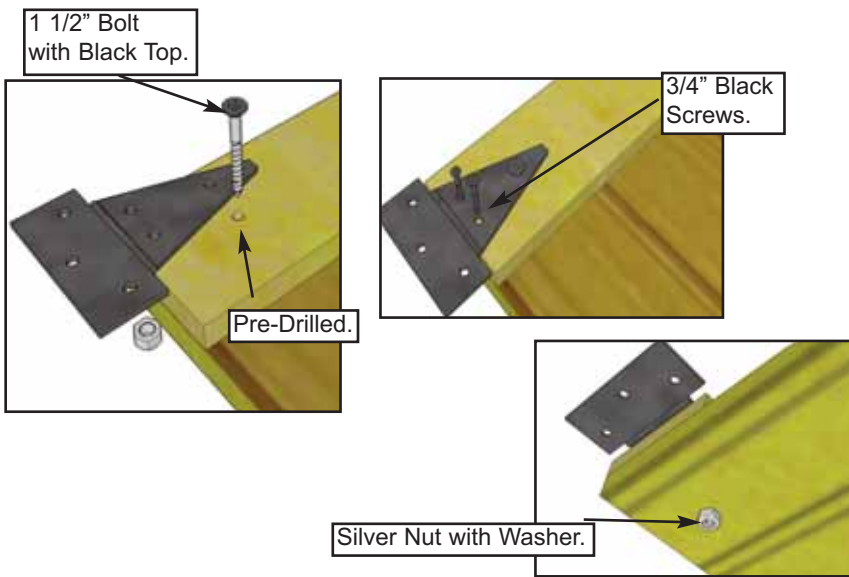

24. Locate Black "Tee" Hinges (U). Attach hinges to horizontal door trim using **1 - 1 1/2" Bolt with Black Head (FF)**.

Note - Door is pre-drilled for bolt. Tighten **Silver Nut** using wrench. Finish hinge by securing with **2 - 3/4" Black Screws (J)**. Drill small pilot holes first to prevent wood from splitting. Complete both doors. (4 hinges). Starting with left side door, lift until hinges contact door trims.

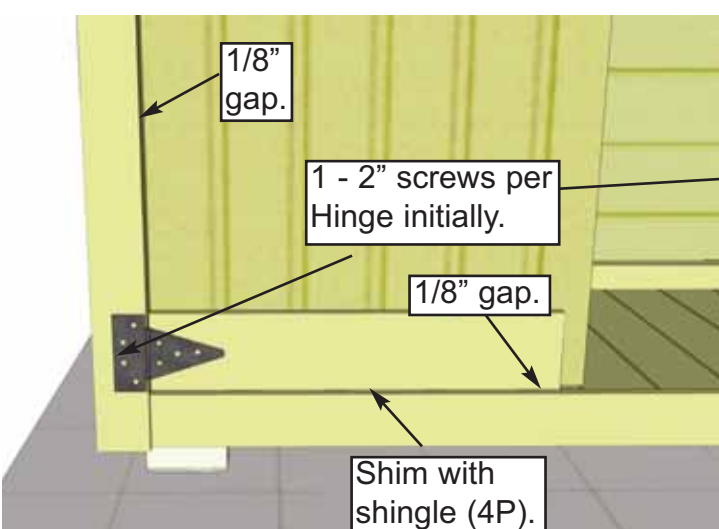
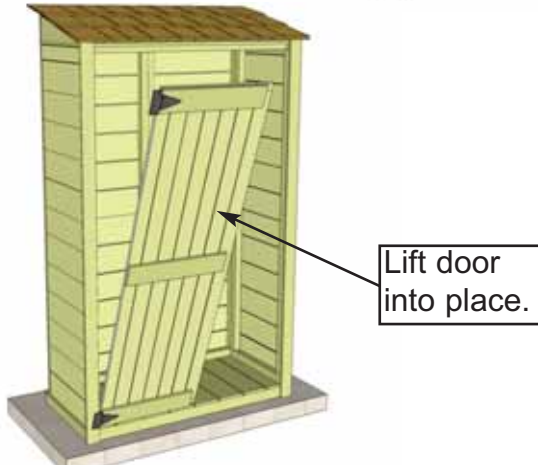

25. Leave a gap on left side and bottom of door approximately 1/8". Use a shingle to shim the door at bottom to help position door evenly. When door is aligned correctly, screw hinge into vertical door frame trim with **3 - 2" Black Screws (H)** per hinge. Use only 1 screw initially per hinge until both door alignments are confirmed. Drill pilot holes to prevent wood from splitting.

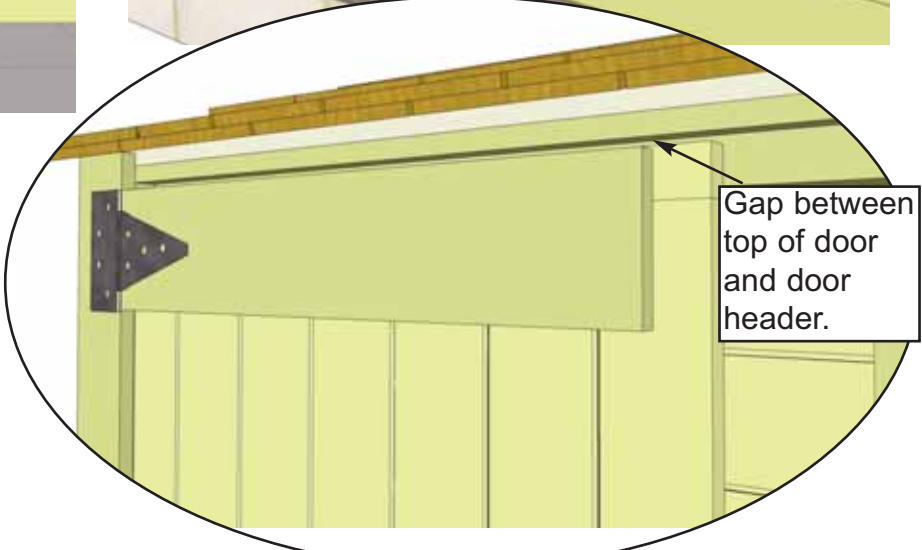

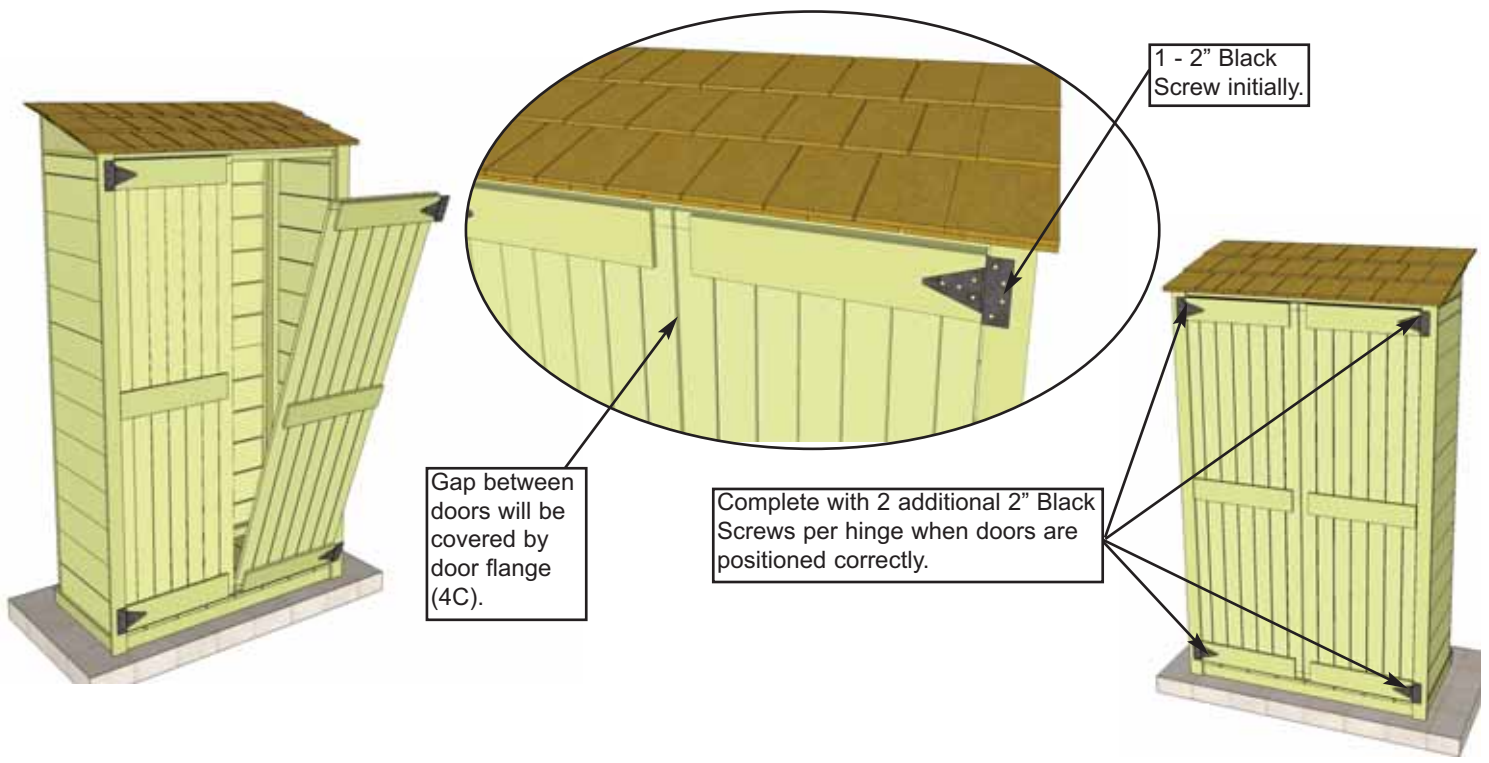

26. Position Right Side Door as per **Steps 24 - 25**. Once again, use only **1 - 2" Black Screw (H)** per hinge initially to secure door to vertical door frame trim. Open and close both doors to confirm proper door closing. Re-adjust door screws if necessary. When satisfied, complete hinge attachments with **2 additional 2" Black Screws (H)** per hinge.

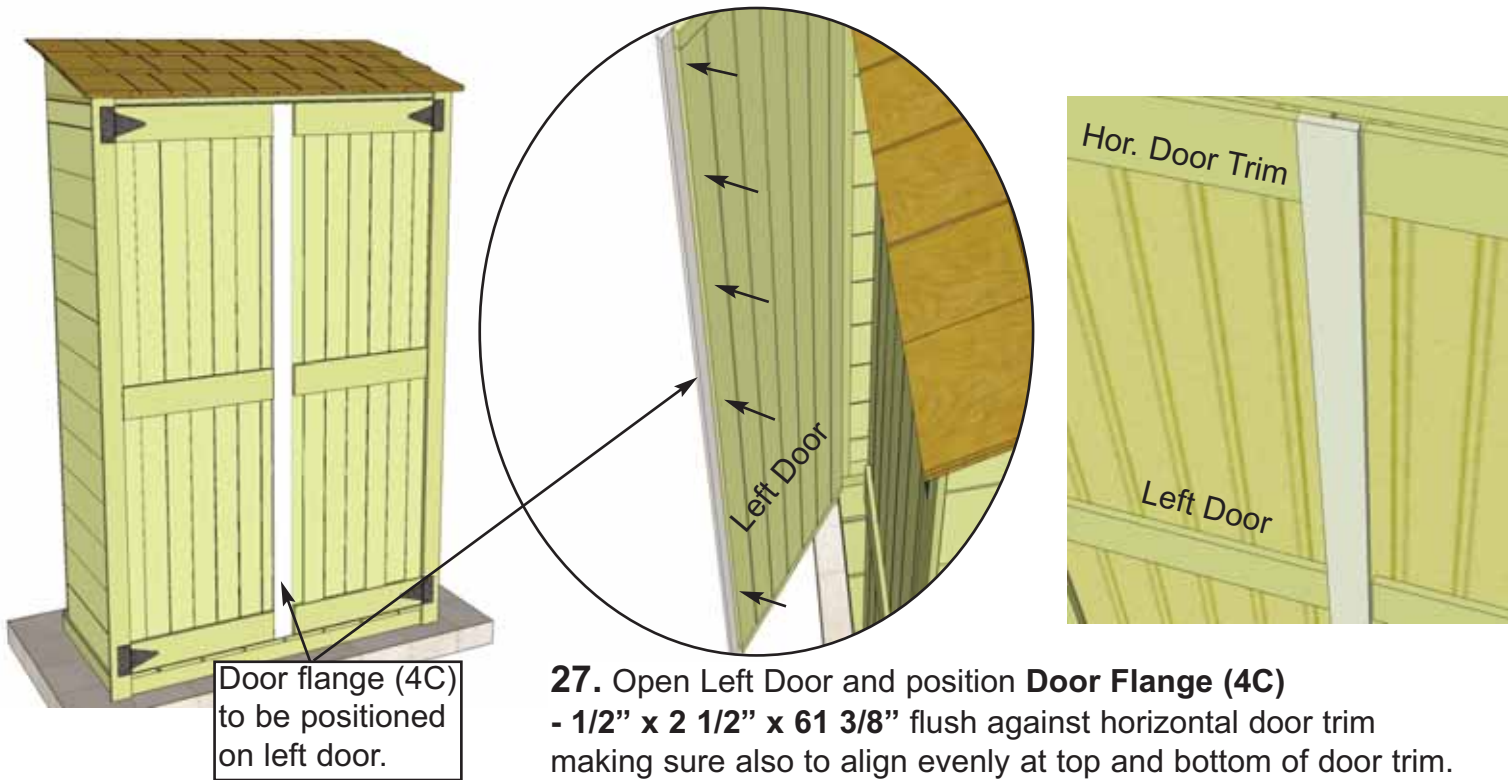

27. Open Left Door and position **Door Flange (4C)** - **1/2" x 2 1/2" x 61 3/8"** flush against horizontal door trim making sure also to align evenly at top and bottom of door trim. From the inside, screw flange to door with **6 - 1" Silver Screws (F)**.

Important - Drill pilot holes first to prevent splitting of wood.

Note: All Trim and Skirting pieces are graded best face rough.

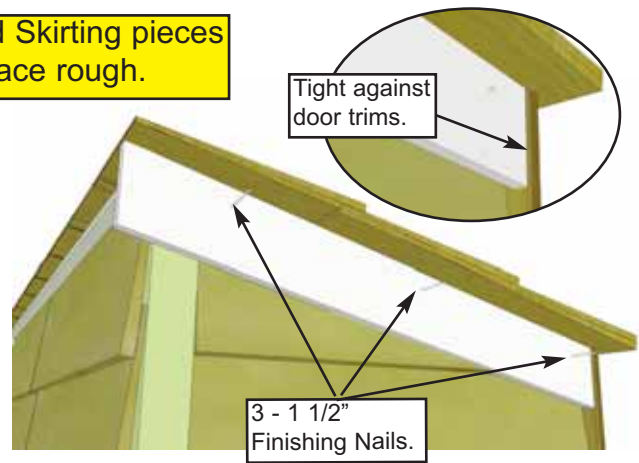
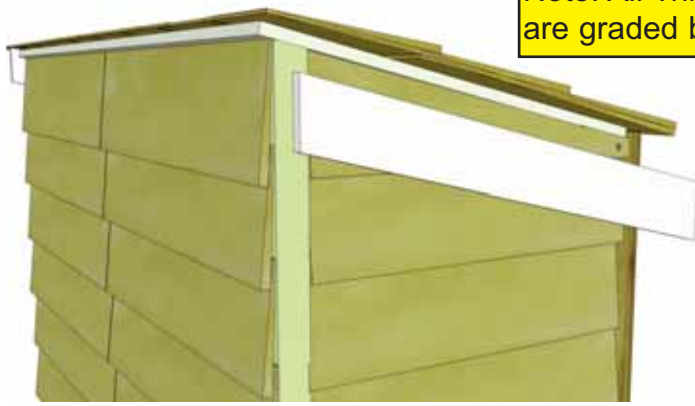

28. Locate and position **Side Facia Trims (4D)** - 1/2" x 2 1/2" x 21 3/4" (angle cut both ends) tight underneath roof and against front corner door trims. Secure with **3 - 1 1/2" Finishing Nails (K)**. **Important** - there are left/right side facia trims. Remember the rough side of the trim faces out and should be used as the best face. Complete both sides.



29. Place **Side / Front Corner Trims (4E)** - 1/2" x 2 1/2" x 61" (angle cut one end) tight against front corner door trim and up underneath side facia trim. The bottom of the trim should be flush to the bottom of the floor. Secure with **6 - 1 1/2" Finishing Nails (K)**. Once again there are left/right side corner trims. Confirm before attaching. Complete both sides.

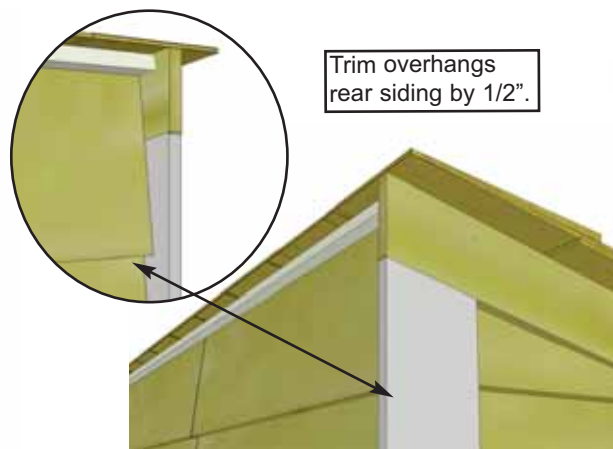

30. Locate **Side / Rear Corner Trims (4F)** - 1/2" x 3 1/2" x 65 1/2" (angle cut one end). Position in rear corner as illustrated above. The side / rear trim will cap the rear trim (4I) found in **Step 33**. Do a dry run to confirm location before attaching. The bottom of the trim should be flush to the bottom of the floor. When correctly aligned, secure each piece with **8 - 1 1/2" Finishing Nails (K)**. Once again there are left/right side / rear corner trims. Confirm before attaching. Complete both sides.

Bevel siding Filler Trim is positioned with the thick butt to the top.

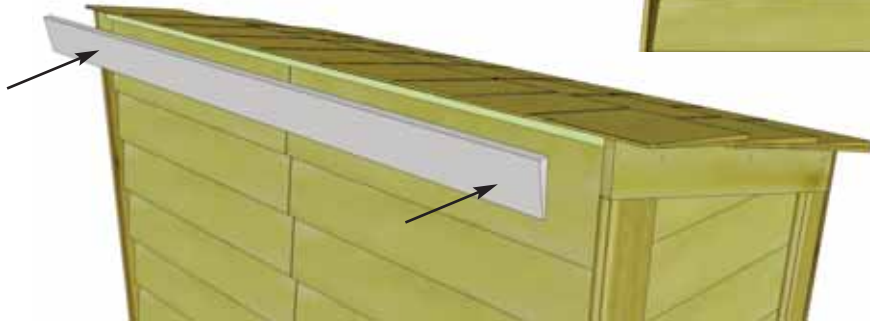
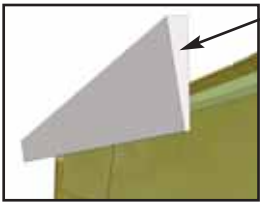

31. Locate Upper Rear Horizontal Filler Trim (4G) - 1/2" x 2 1/2" x 45 1/2" (Bevel - thick and thin top/bottom). Position tight underneath roof shingles in the rear with thick butt facing up and evenly spaced from side-to-side. Attach with **6 - 1 1/2" Finishing Nails (K)**.

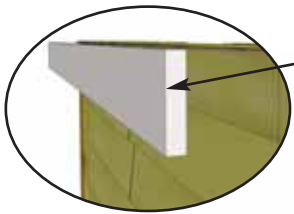

Rear Hoz. Trim sits on against filler.

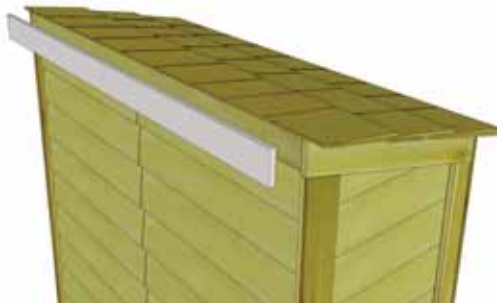

32. Locate Upper Rear Horizontal Trim (4H) - 1/2" x 2 1/2" x 45 1/2". Position against rear horizontal filler and tight underneath roof shingles. Attach with **6 - 1 1/2" Finishing Nails (K)**.



Tight underneath hor. filler and against rear corner trim.

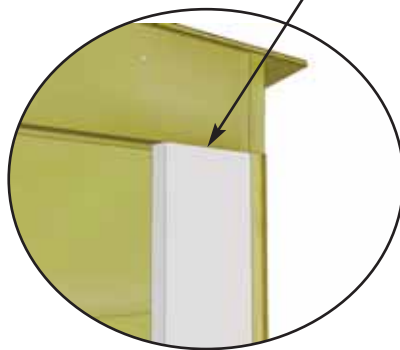

33. Locate and position Rear Corner (2 pcs) and 1 Center Trim (4I) - 1/2" x 2 1/2" x 65 1/2" tight underneath horizontal filler and against rear corner trim. Attach with **6 - 1 1/2" Finishing Nails (K)**. **Complete both sides.** Position **Center Trim** to middle wall seam and attach with **6 - 1 1/2" Finishing Nails (K)**.

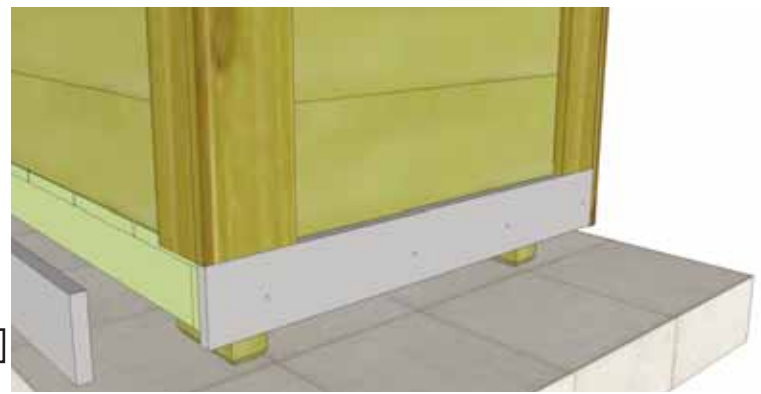
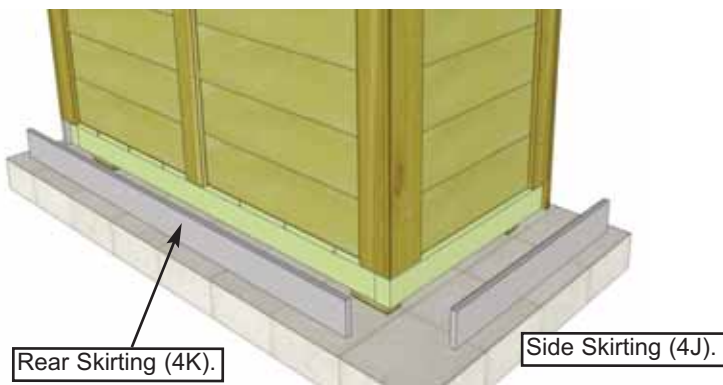

34. Locate **Bottom Side Skirting (4J)** - 1/2" x 2 1/2" x 21 1/8" and **Bottom Rear Skirting (4K)** - 1/2" x 2 1/2" x 45 1/4" pieces. Starting with the sides, position tight to corner door trim and flush underneath corner trims. Secure with **3 - 1 1/2" Finishing Nails (K)**. Complete both sides.



35. Position rear skirting piece between side skirtings and underneath rear and center trims. Secure with **6 - 1 1/2" Finishing Nails (K)**. Locate **Front Bottom Skirting (4L)** - 1/2" x 2 1/2" x 41 1/4" and place between front corner door trims even with the bottom of the floor. Secure with **6 - 1 1/2" Finishing Nails (K)**.



Front Door Header Trim (4M).



36. Locate **Front Door Header Trim (4M)** - 1/2" x 1" x 41 1/4" and place between corner door trim flush against door header and plywood roof sheathing. Make sure door header trim is positioned so it does not impede the opening and closing of doors. When correctly positioned, secure with **5 - 1 1/2" Finishing Nails (K)**.

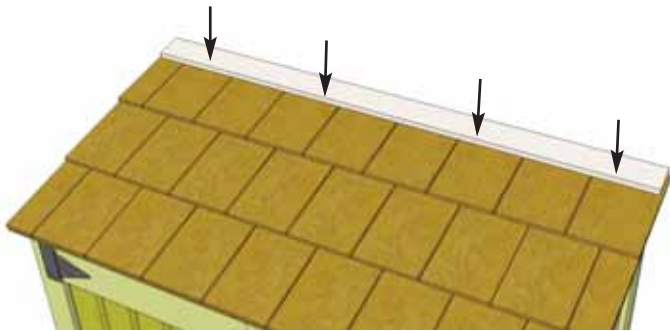
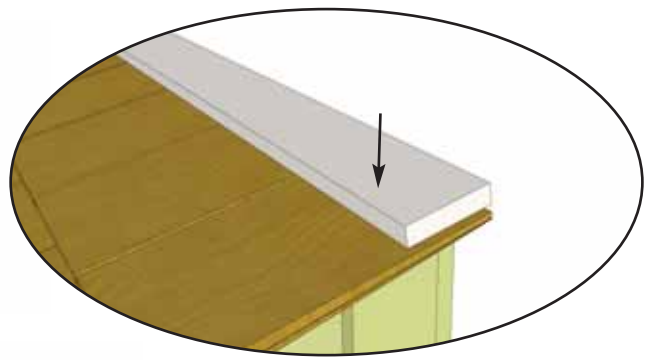
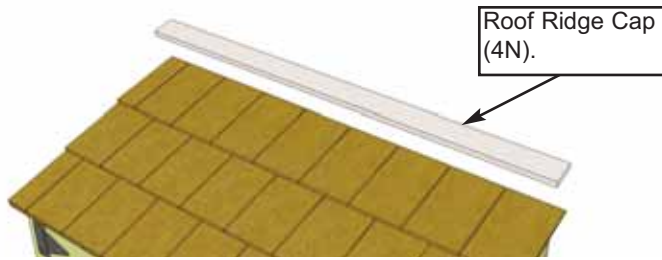

37. Center **Roof Ridge Cap (4N)** from side to side on the rear roof shingles. Overhang the ridge cap slightly off the back of the shingles. Secure with **4 - 2" Screws (D)**. Be sure to screw through the ridge cap and into rear wall framing. Drill pilot holes in ridge cap to prevent wood from splitting.

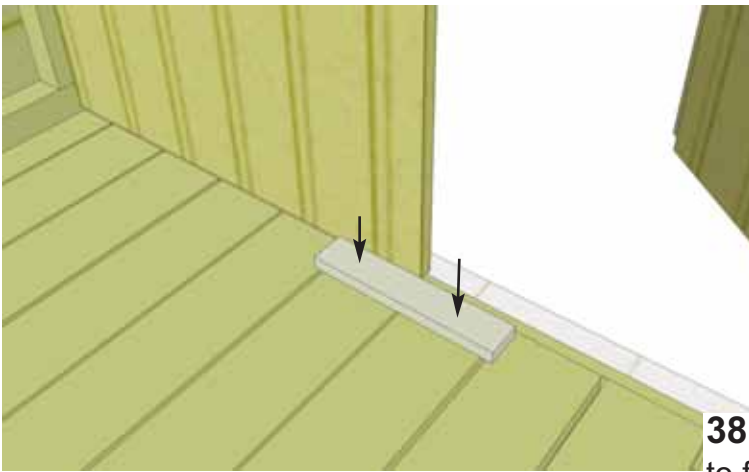

38. Attach **Lower Door Stop (40) - 3/4" x 1 1/2" x 8"** to floor with **2 - 1 1/4" screws (E)**. To align correctly, close doors in best close door position. Mark and attach. Drill pilot holes to prevent splitting.

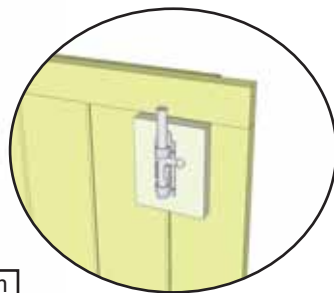

39. Install the **Barrel Bolt Plywood Spacer (UU) - 1/2" x 2 3/4" x 2 3/4"** 3/4" from top of the right door with **2 - 1" Silver Screws (F)**. Position the **Interior Silver Barrel Bolt (BB)** on the plywood spacer and attach with **4 - 3/4" Silver Screws (G)**. Tap barrel of bolt with Hammer to mark location on header. Open door and Drill with a 3/8" bit.

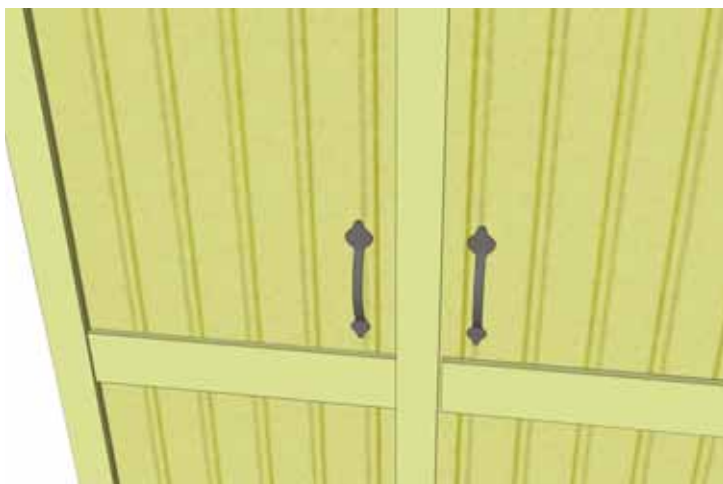

40. Attach Door Handles (X). Handles are positioned on top section of each door and mounted with **4 - 3/4" Black Screws (J)** per handle. Attach **Black Barrel Bolt (W)** as illustrated above with **6 - 3/4" Black Screws (J)**. Note how female part of barrel bolt is positioned higher than male. Do a dry run first to position barrel bolt correctly. **Important** - drill pilot holes with 1/8" drill bit prior to securing with screws to prevent wood splitting.



Congratulations on assembling your 4x2 Garden Chalet!

Note; Our Sheds are shipped as an unfinished product. If exposed to the elements, the Western Red Cedar lumber will weather to a silvery-gray color. If you prefer to keep the cedar lumber looking closer to the original color, we suggest that you treat the wood with a good oil base wood stain. You may also wish to paint your new shed rather than stain it. In both cases we recommend that you consult with a paint and stain dealer in your area for their recommendations.

We hope your experience constructing our **4x2 Garden Chalet** has been both positive and rewarding. We value your feedback and would like to hear back from you on how well we are doing in the following areas:

1. **Customer Service**
2. **On Time Shipping**
3. **Motor Freight Delivery**
4. **Quality of Materials**
5. **Assembly Manual**
6. **Overall Satisfaction.**



Please call, write or email us at:

Canadian Address
9393 287th Street
Maple Ridge, British Columbia
Canada V2W 1L1

United States Address
P.O. Box 96
Sumas, Washington
USA 98295

The materials contained in this Assembly Manual may be downloaded or copied provided that ALL copies retain the copyright and any other proprietary notices contained on the materials. No material may be modified, edited or taken out of context such that its use creates a false or misleading statement or impression as to the positions, statements or actions.