

OLM Retractable Canopy for
10X16 Breeze Pergola
by
Outdoor Living Today

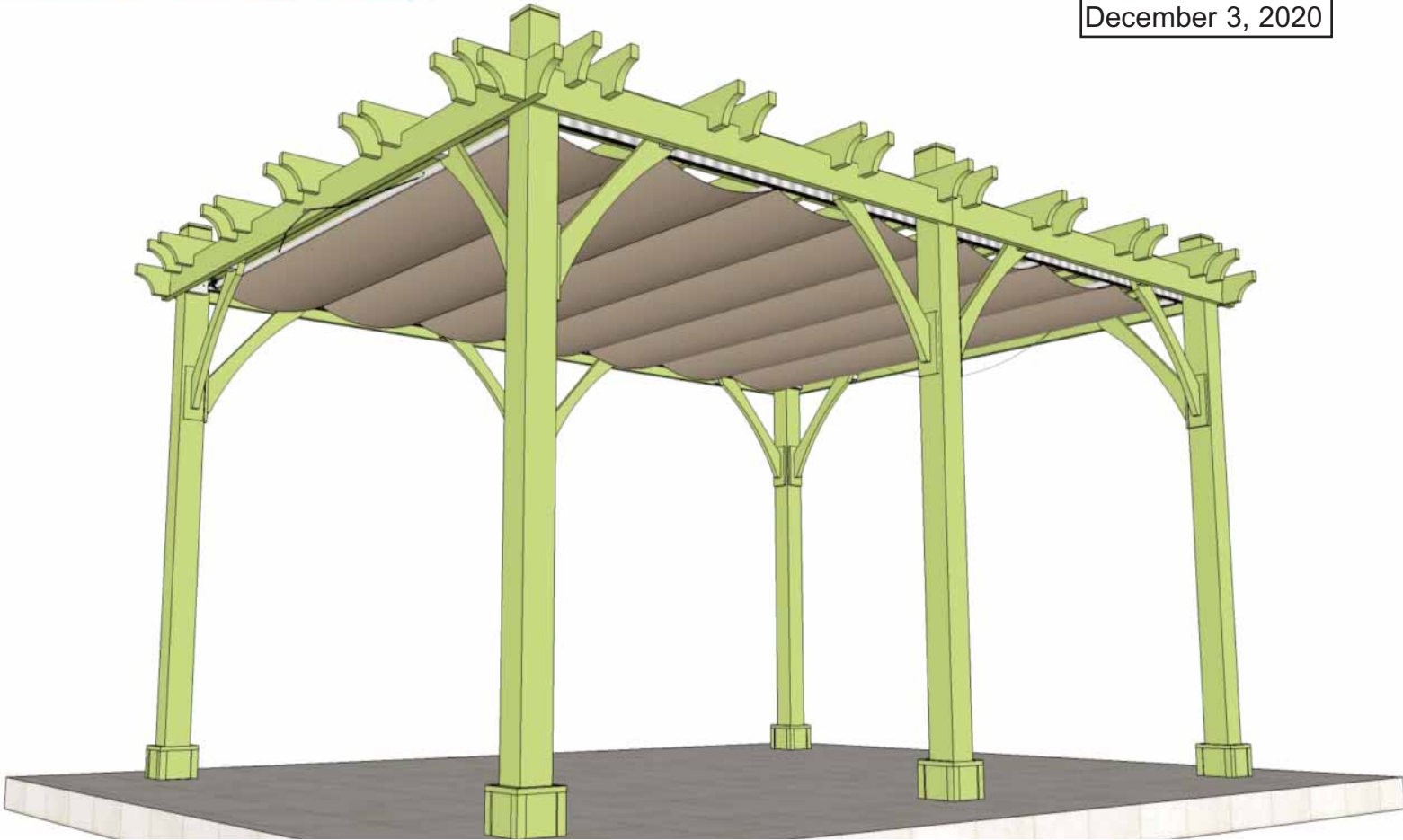

Revision #3
December 3, 2020



Care and Maintenance -

Do not leave canopy extended during heavy snow storms or any extreme weather conditions. Reasonable care should be taken to remove accumulated dirt and debris in track. Canopy Tracks may have sharp corners. Always use gloves when handling to prevent cuts. Lubrication (supplied in kit) of wing wheels and track should be done annually. Wing and canopy can be removed seasonally to improve longevity. To keep the Harbor-Time canopy fabric looking clean and bright, wash periodically with a soft brush, warm water and mild soap. Do not use detergent. 5 year limited manufacturer's warranty on the Harbor-Time canopy fabric.

Customers agree to hold Outdoor Living Today and any Authorized Dealers free of any liability for improper installation, maintenance and repair of any Outdoor Living Today products.

In the event of a missing or broken piece, simply call the Outdoor Living Today Customer Support Line @ 1-888-658-1658 within 30 days of the delivery of your purchase. It is our commitment to you to courier replacement parts, free of charge, within 10 business days of this notification. Replacement parts will not be provided free of charge after the 30 day grace period.



Once your pergola and retractable canopy have been correctly installed, do a water test to confirm water is draining properly from the canopy.

Please contact us immediately if large amounts of water remain in each fabric fold when extended. The Canopy is designed to hold several gallons of water per fold. If more than a gallon of water is collecting in each fold, keep the canopy closed until a solution is found. Failure to do so could void your warranty.

Trouble Shooting

Water Not Draining From Canopy

Possible Causes:

- Canopy Fabrics needs more drop. If fabrics are too tight when extended, water will not drain properly. Try lowering anchor knobs on both ends to increase fabric drop.
- Slope of Canopy not steep enough. Pergola could be sloped the wrong direction. A deeper Lowering Cleat may be required.

Canopy Not Rolling Back and Forth Smoothly on Tracks

Possible Causes:

- Tracks and Wheels need to be Lubricated.
- Check Track to confirm it is straight. Bend or move track to straighten if possible.
- Mounting Track fasteners are impeding wheels. Check and adjust if necessary.

10x16 Breeze Pergola Retractable Canopy Parts List



1 1/4" Brown Wood Screws -
7 Pcs.



1 1/2" Torx Screws -
24 Pcs.



4" Torx Screws
8 Pcs.



A - Canopy Lowering Cleat - 3 Pcs.
- 1 1/2" x 2 1/2" x 37 1/4" x 2pcs
- 1 1/2" x 2 1/2" x 66" x 1pc



B - 96" long Canopy Tracks - 2 Pcs.
- 91 1/2" long Canopy Tracks - 2 Pcs.

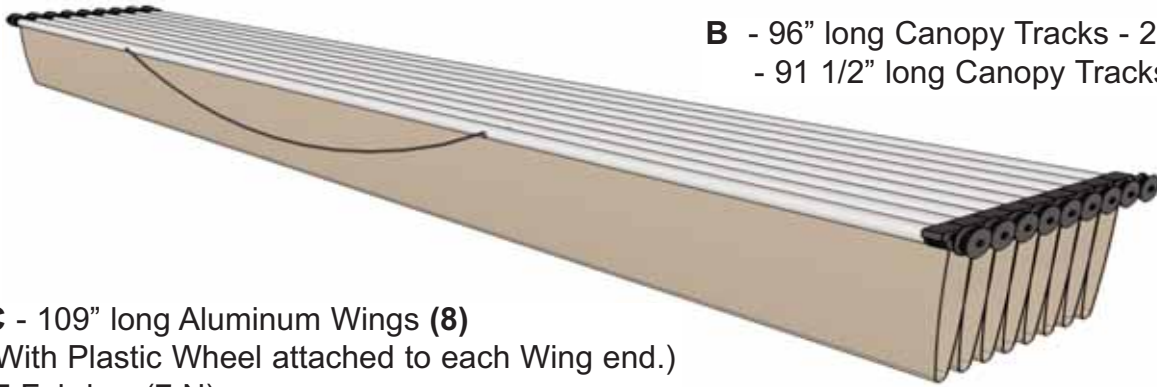

C - 109" long Aluminum Wings (8)
(With Plastic Wheel attached to each Wing end.)
7 Fabrics. (7 N)
(ON_N_N_N_N_N_ON)
Maximum Fabric Displacement = 185"
Actual Fabric Displacement = 189 1/4"
(4 1/4" Drop)
Actual Aluminum Wing Length - 106 1/4"
Actual Fabric Length - 106 1/2"

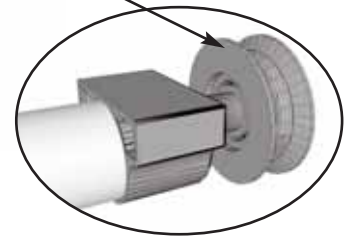

D - Aluminum Wing Stop
4 1/4" Long- 2 Pcs.
2 drill holes.



E- Wing Anchor Knobs
- 3 Pcs.



F- Canopy Pull Handle



Track Lubricant - 1 Bottle.



Square Drive Bit
1 Pc.



Torx Drive Bit
1 Pc.



1/4" Drill Bit
1 Pc.



4" long x 1/4" diameter Plastic Rail Connector - 2 Pcs.

Tools and Safety Equipment Required (Not Provided)



Screw Gun/Drill



Level



Tape Measure



2 Ladders



Safety Glasses



Work Gloves

Installation of the OLM Retractable Canopy couldn't be easier. Just 4 Easy Steps!

1. Attach lowering cleat and canopy tracks to pergola framing.
2. Lift aluminum wings with canopy and feed wheels into track.
3. Position aluminum wing stops and attach.
4. Install knobs to anchor both ends of your canopy.

Installation will require 2 people.

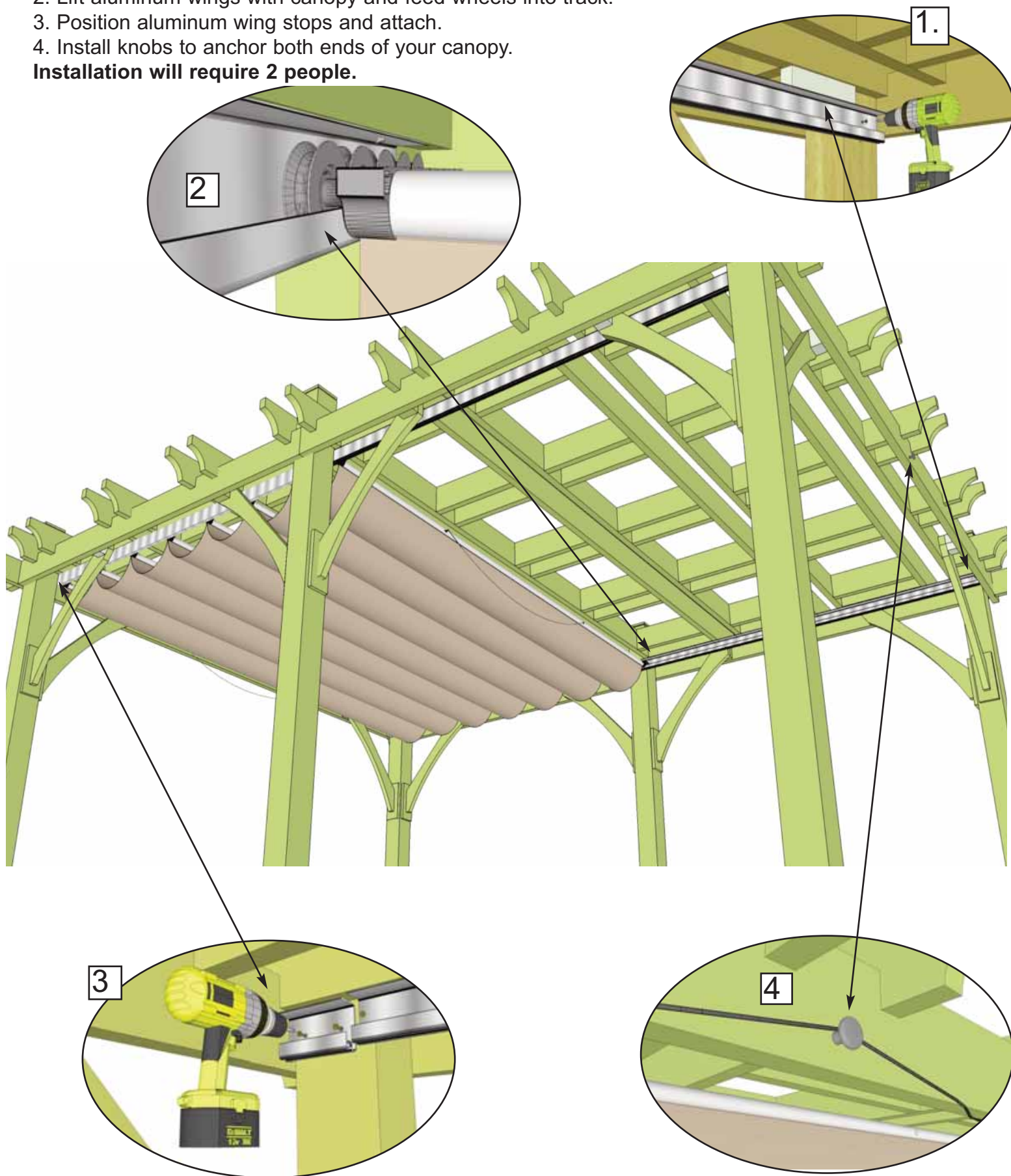

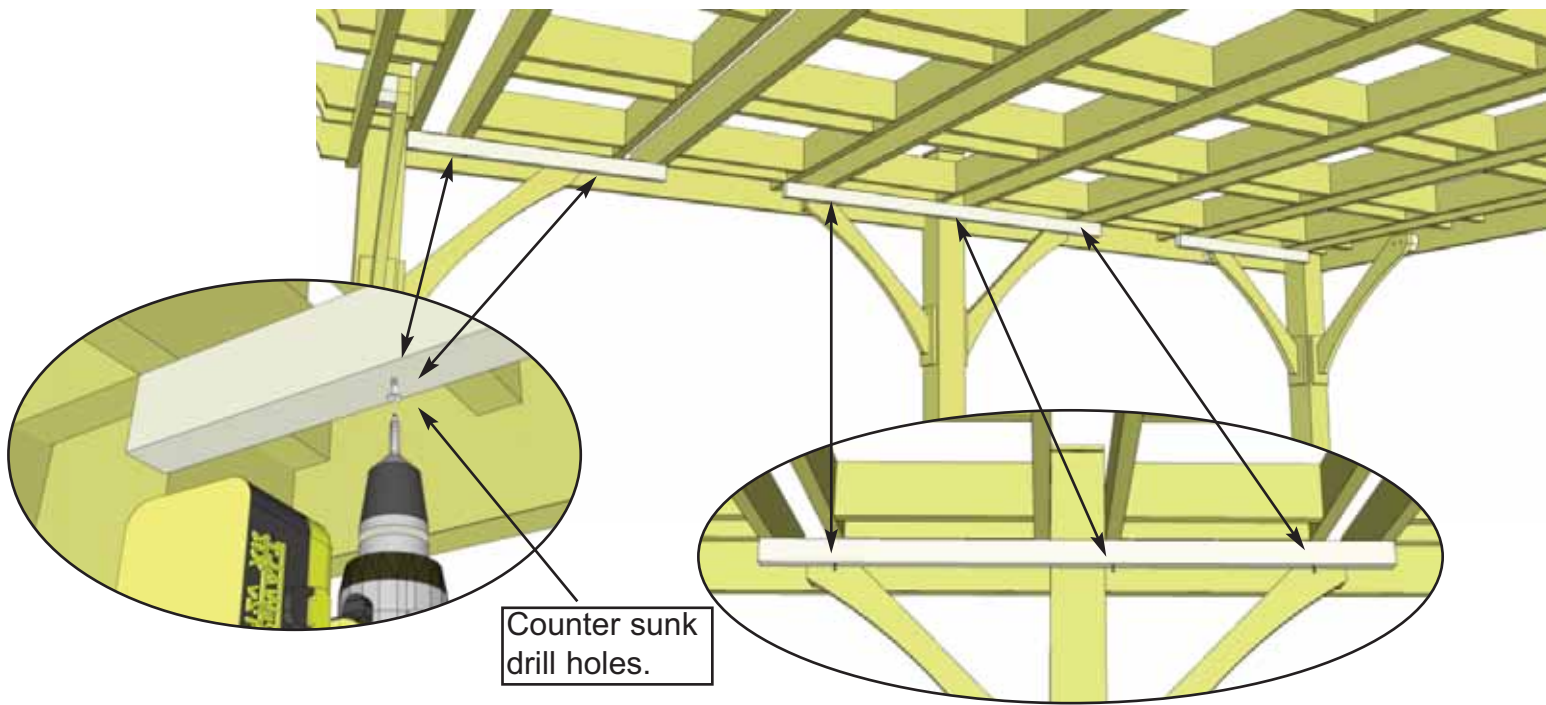

1. With a Step Ladder, install **Part A - Canopy Lowering Cleats - 3 pcs Total. (2 pcs. @ 1 1/2" x 2 1/2" x 37 1/4") & (1 pc. @ 1 1/2" x 2 1/2" x 66")**. Attach with **2-3 - 4" Torx Screws**. Cleats will lower the canopy on one side and drain water off the fabric so it doesn't collect excessively. Decide best side for water to drain for your situation. Position cleats underneath pergola joists or blocking as shown above and attach. Cleats are pre-drilled for Torx Screws.

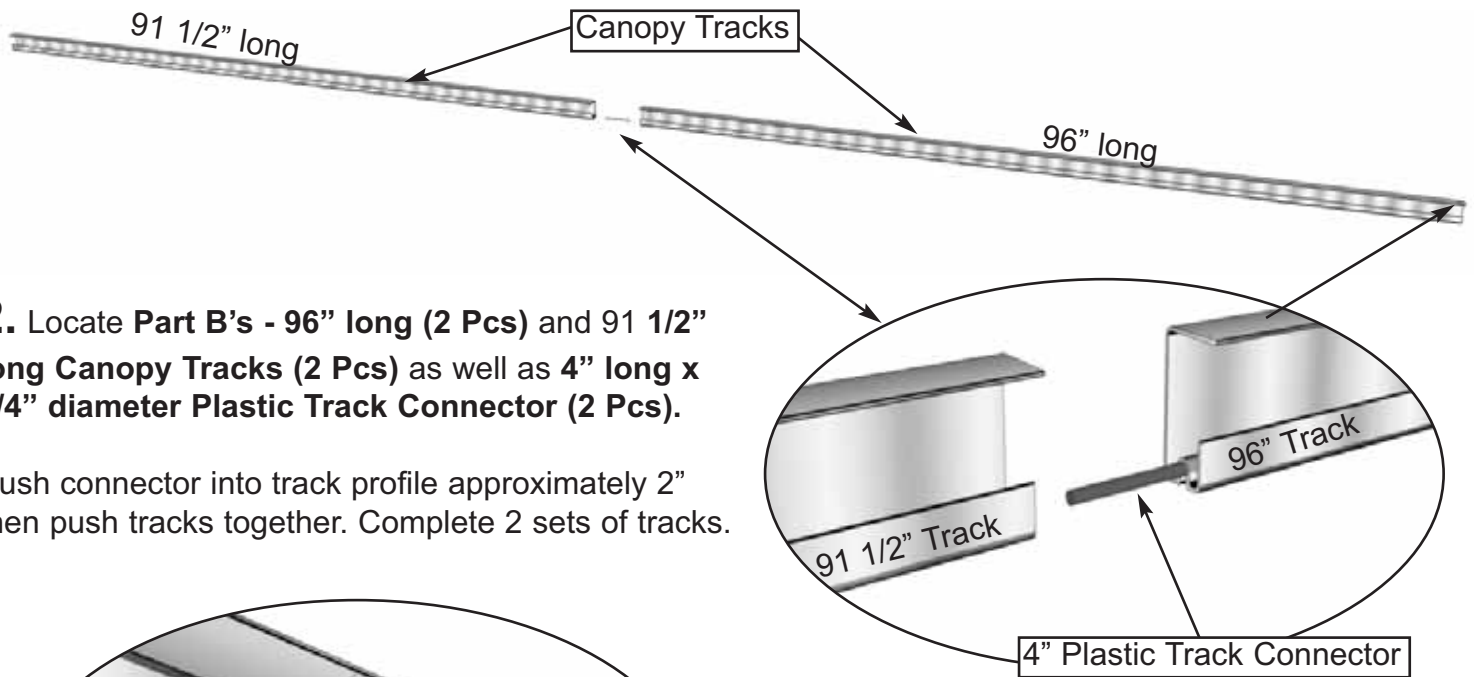

2. Locate **Part B's - 96" long (2 Pcs)** and **91 1/2" long Canopy Tracks (2 Pcs)** as well as **4" long x 1/4" diameter Plastic Track Connector (2 Pcs)**.

Push connector into track profile approximately 2" then push tracks together. Complete 2 sets of tracks.

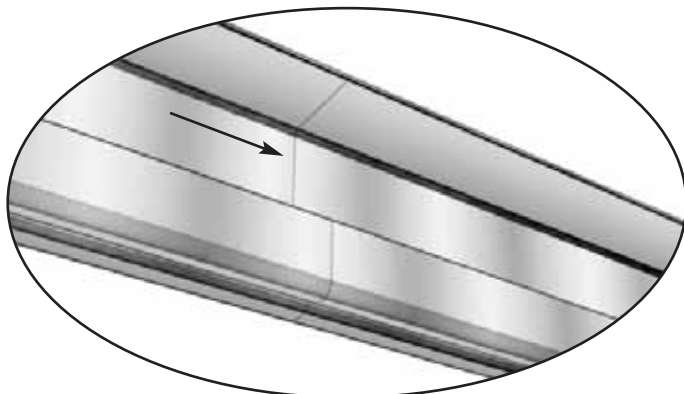

Plastic Connector helps align Track and is not structural. Carefully support connected track when lifting.

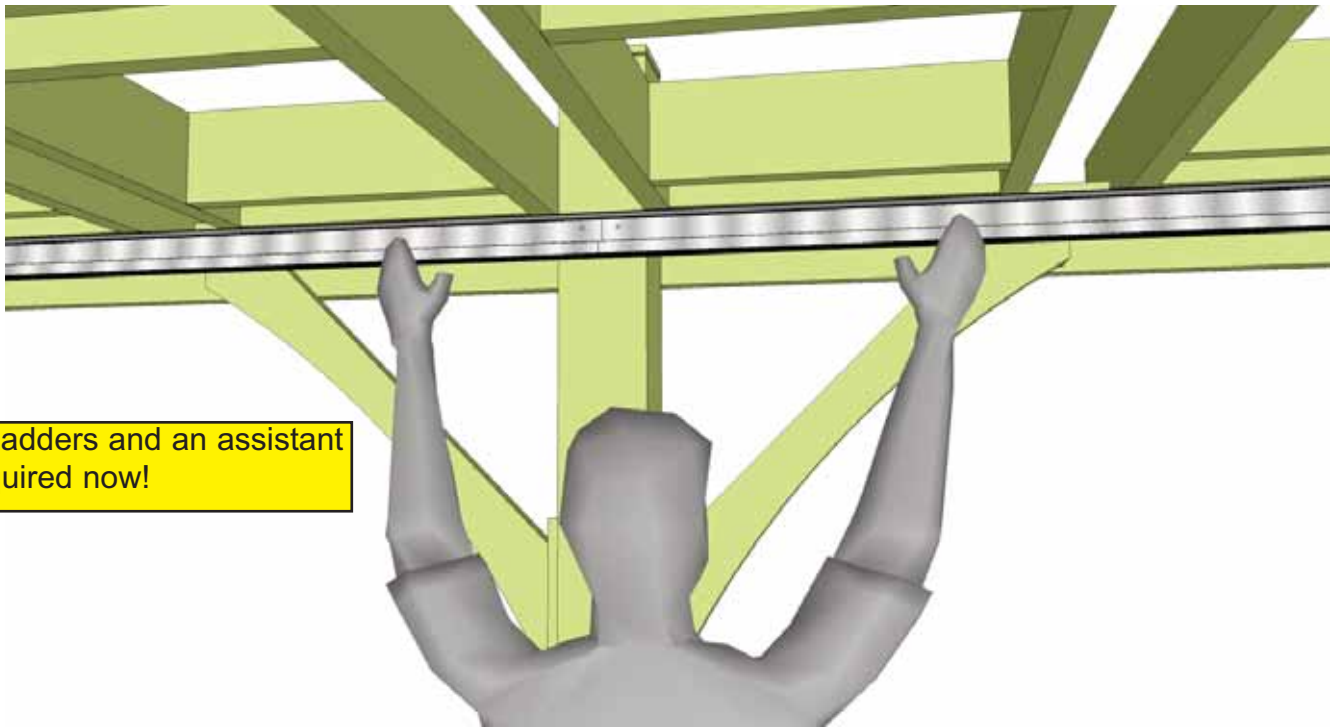

2 Ladders and an assistant required now!

3. Carefully lift connected track up supporting in the center. Place tight against post and underneath pergola joists.

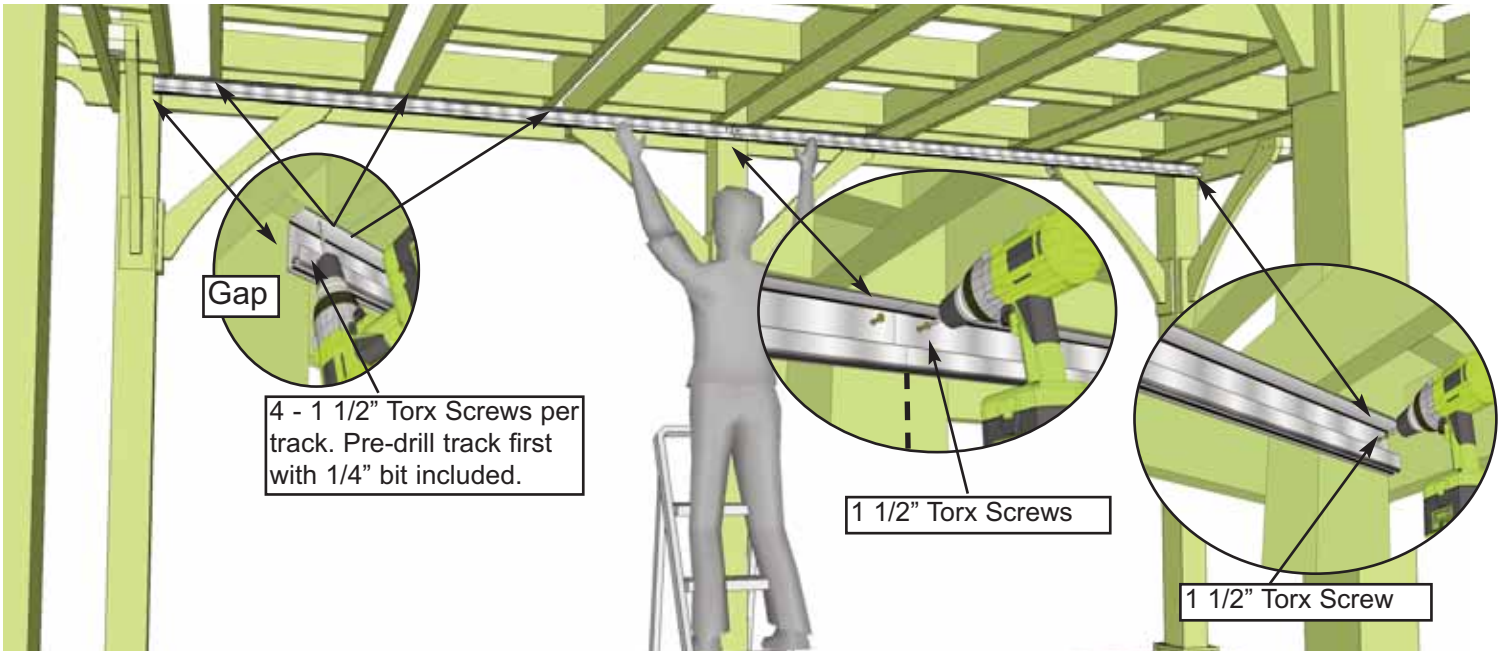

Gap

4 - 1 1/2" Torx Screws per track. Pre-drill track first with 1/4" bit included.

1 1/2" Torx Screws

1 1/2" Torx Screw

4. Before attaching, confirm track is centered on mid post. Attach track with 1 - 1 1/2" Torx Screw on gap end screwing up through the track into bottom of wood joist. On opposite end, attach track to post with 1 - 1 1/2" Torx Screw. Do not over tighten. Drill hole in track with 1/4" drill provided. At mid post, screw track to post with 2 - 1 1/2" Torx Screws. Drill track again with 1/4" bit provided. Secure track further with 3 - 1 1/2" Torx Screws screwing up through the track into bottom of wood joist. Pre-drill with 1/4" bit included in kit first. Complete both sides.

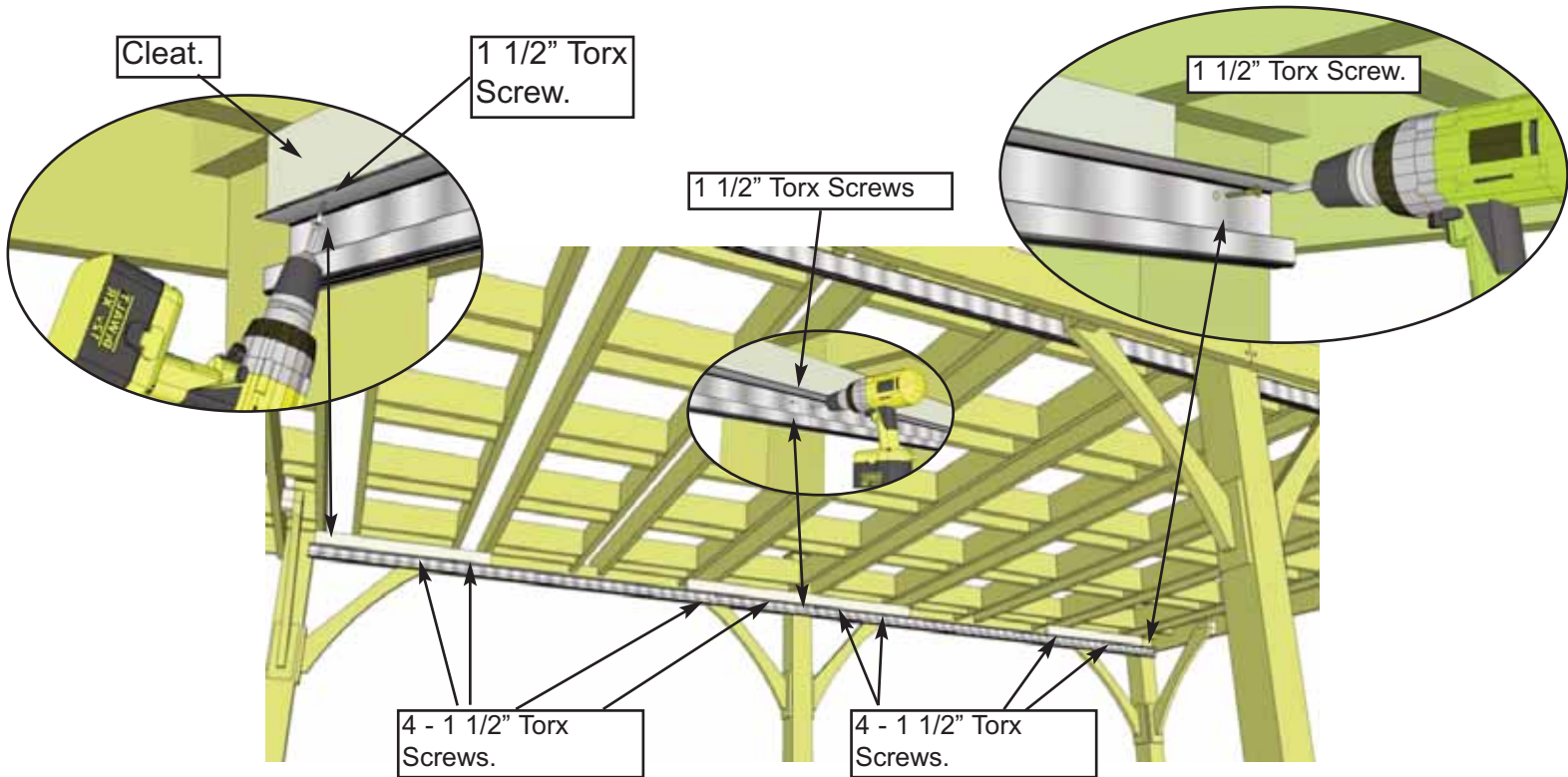

5. Align and attach second **Canopy Track** directly underneath lowering cleats as per **Step 4**. Position track flush against post as illustrated above. At mid post, screw track to post with 2 - 1 1/2" Torx Screws. Pre-drill first with 1/4" bit.

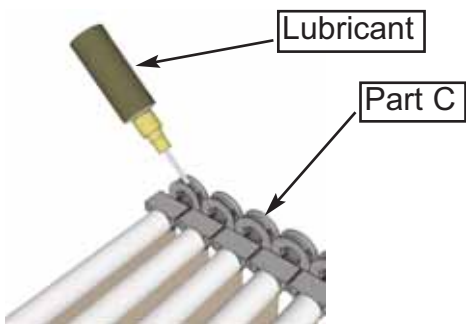
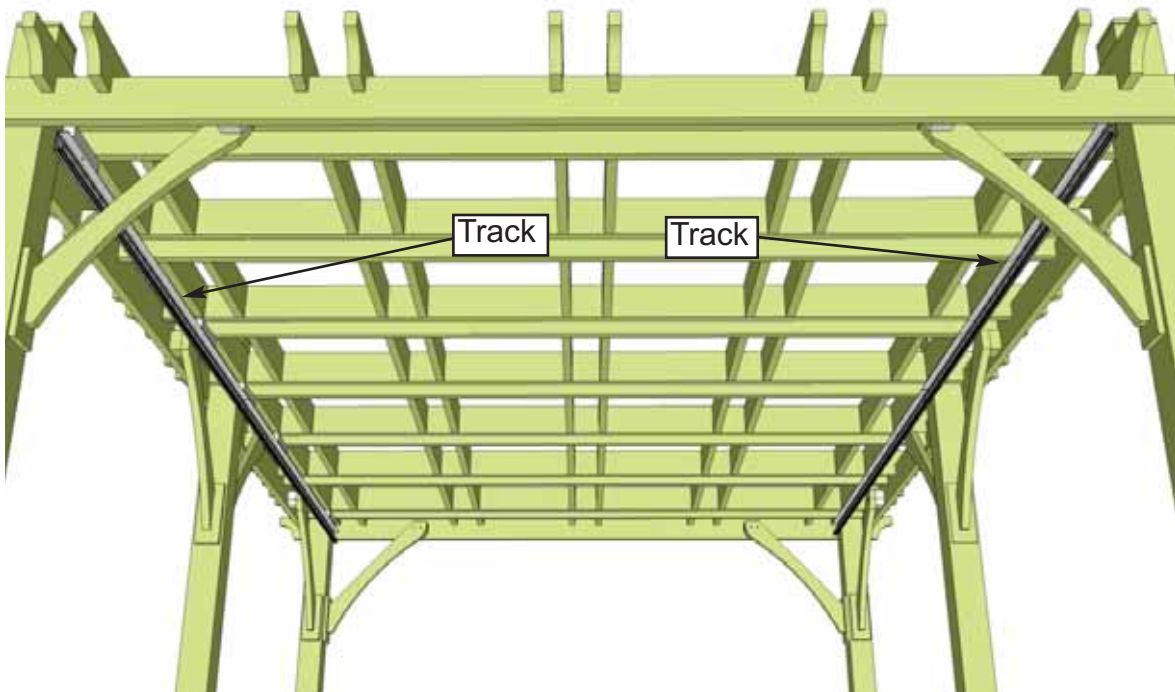

6. Prior to feeding **Part C - Aluminum Wings and Canopy** into track, locate Lubricant in Hardware Pack and apply a small amount to top of each wheel. Spin wheel slowly to lubricate entire surface. Complete all wheels.

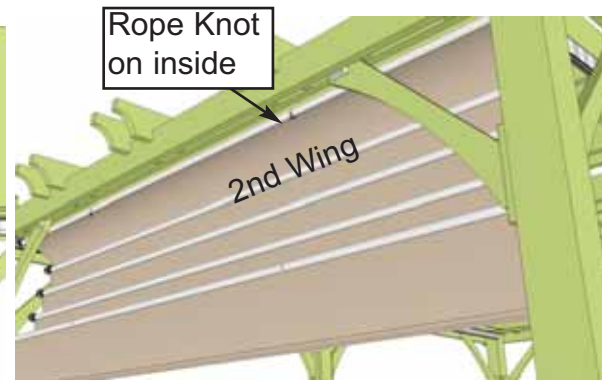
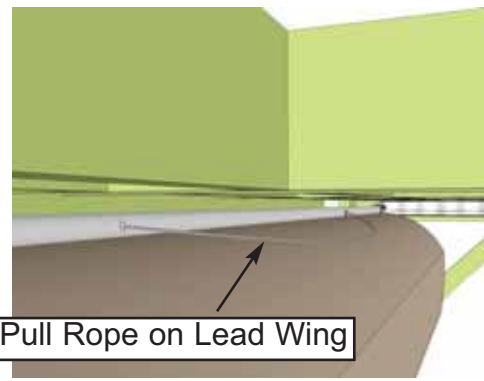
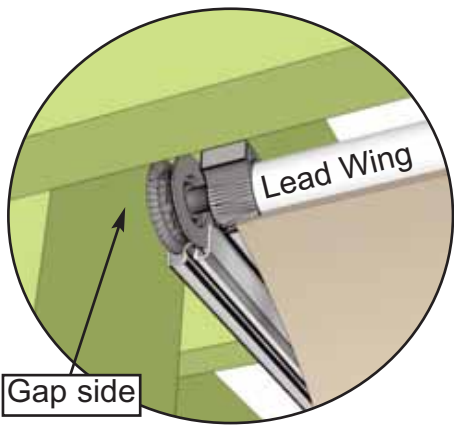

7. Before feeding **Part C - 109" long Aluminum Wings (8)** with **Canopy** into track, make sure canopy fabric is facing the correct direction. First, locate Lead and Anchor Wings in set. Both have a black pull rope attached. Make sure rope knots are facing to the inside and the pull rope is facing to the outside. Starting with the Lead Wing, feed the wing wheels onto the track as shown above. Wheels have springs and compress in and out slightly to fit.

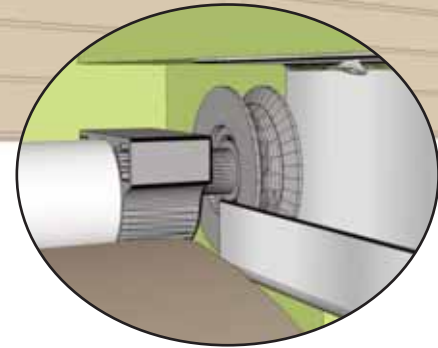

Important- Ensure rope knots are on the top side of the canopy, facing the center of the pergola so that pull rope is accessible.
You will need 2 Ladders and a helper to feed the wings into track.

Caution- Avoid installing canopy during heavy winds!

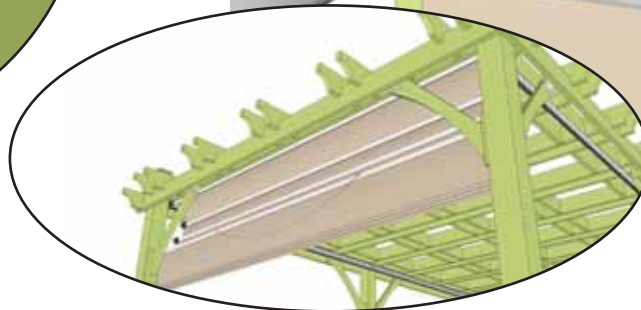
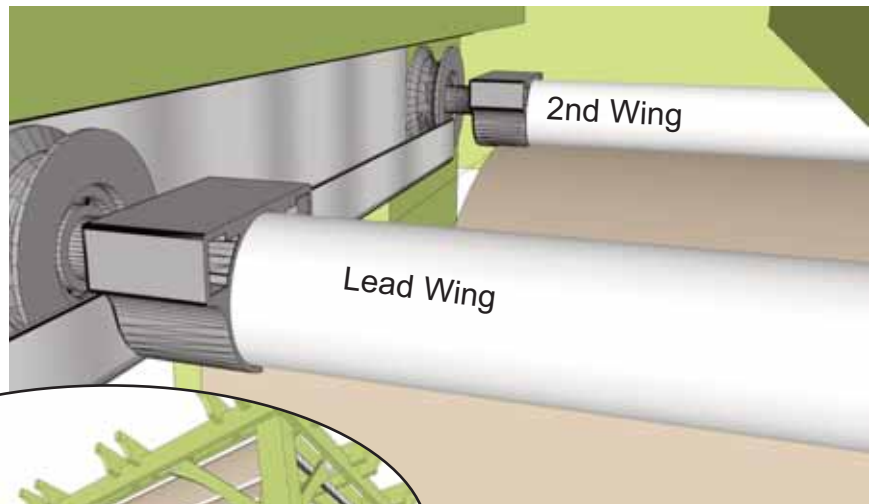
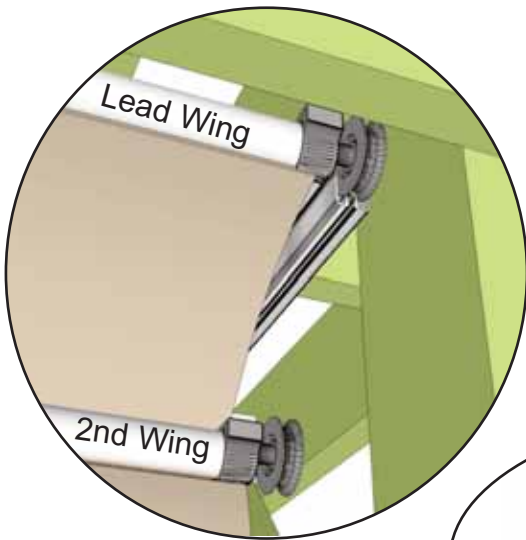

8. Push Lead Wing slightly ahead on track. Wings can roll out of track until **D - Aluminum Wing Stop (2 Pcs.)** are installed so be careful. Lift and feed 2nd Wing into track and push wing slightly forward.

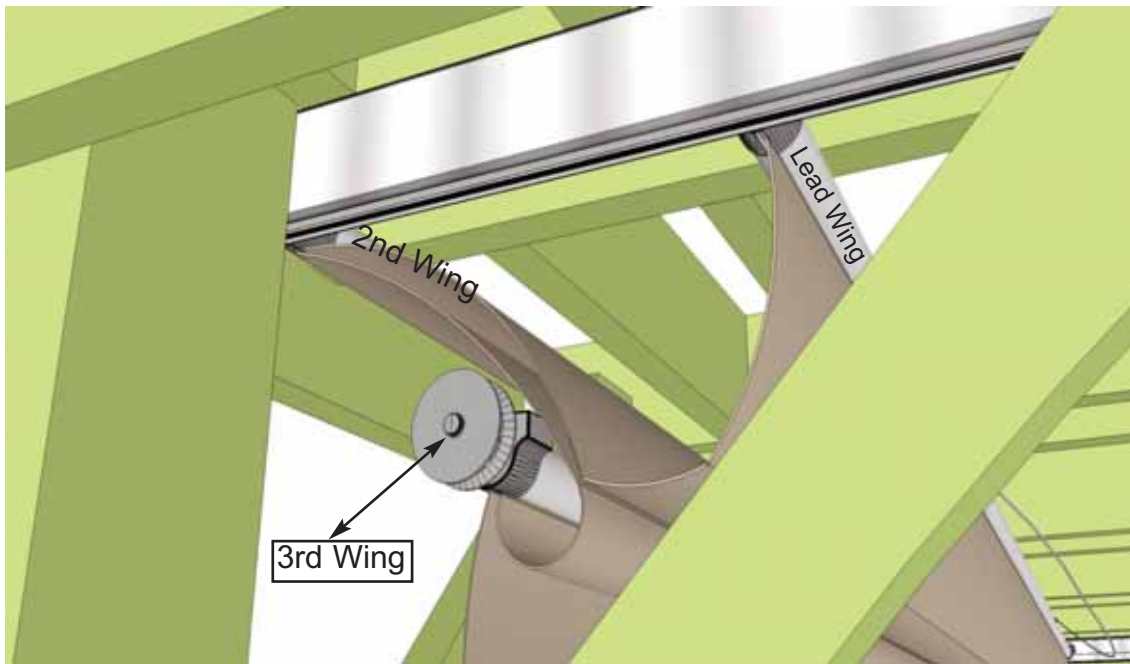

9. Continue to feed wings into the track until all wings are installed.

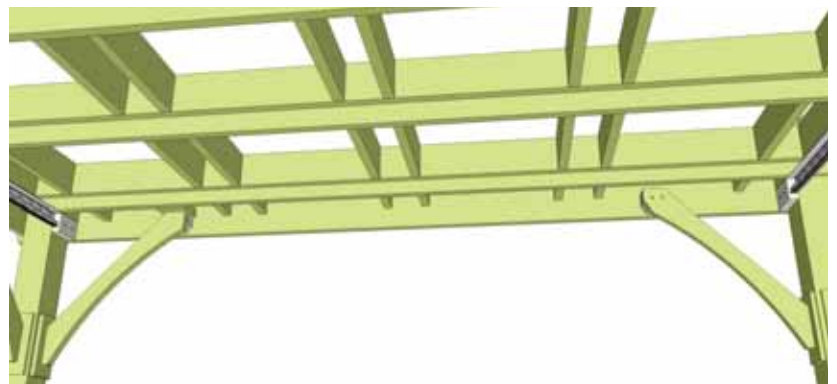
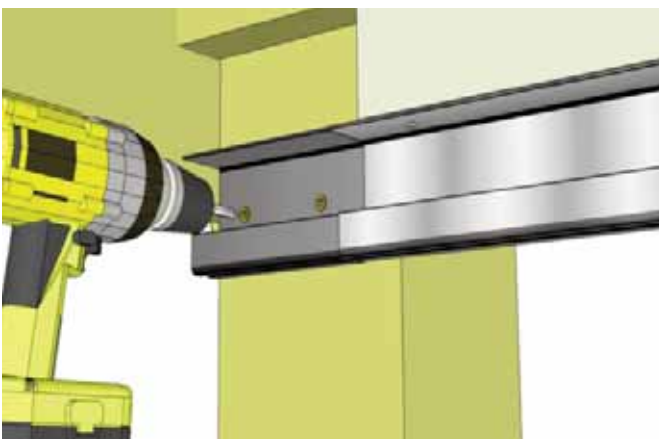
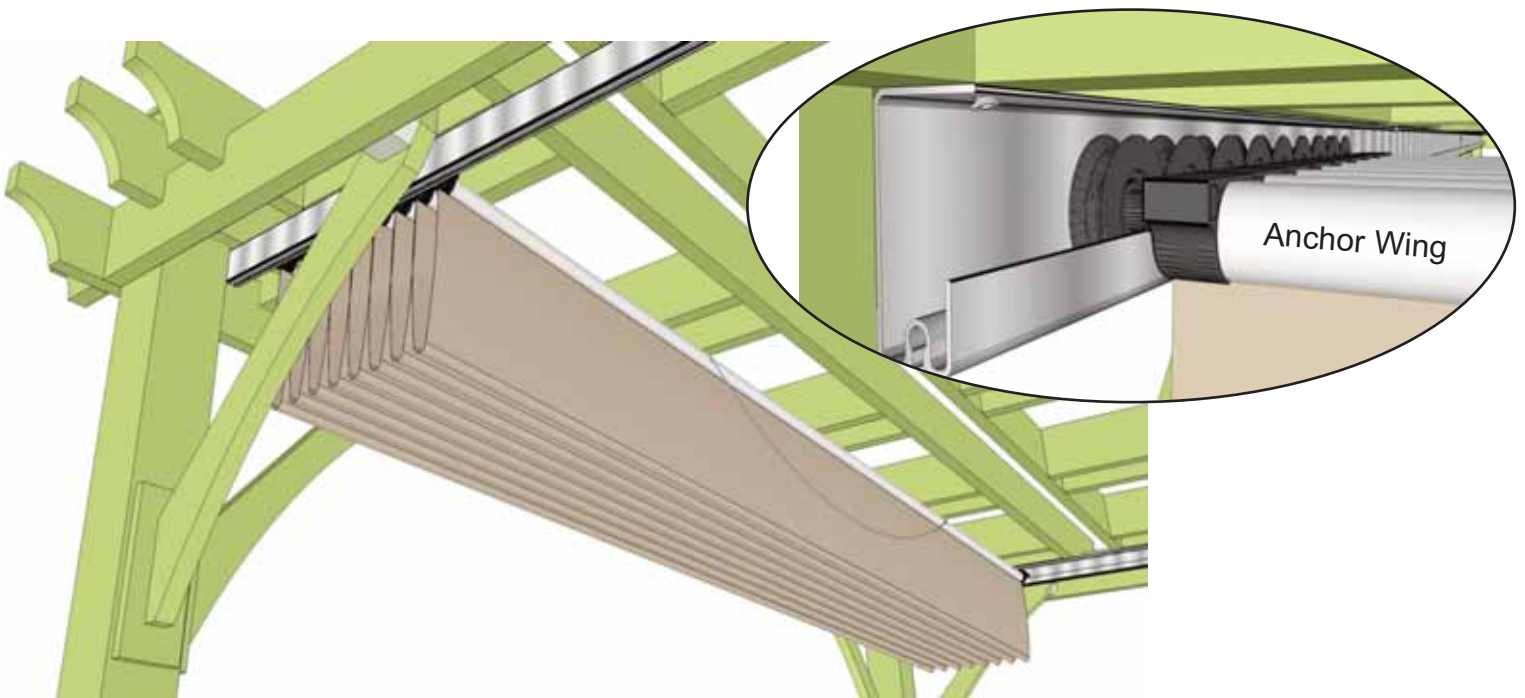

10. Install **Part D - 4 1/4" long Aluminum Wing Stops - 2 Pcs.** where track ends and gap exists. Use 2 - 1 1/4" brown screws per stop to install. When removing the wings and canopy in the future, simply remove wing stops and roll wing and canopy out carefully with a helper.

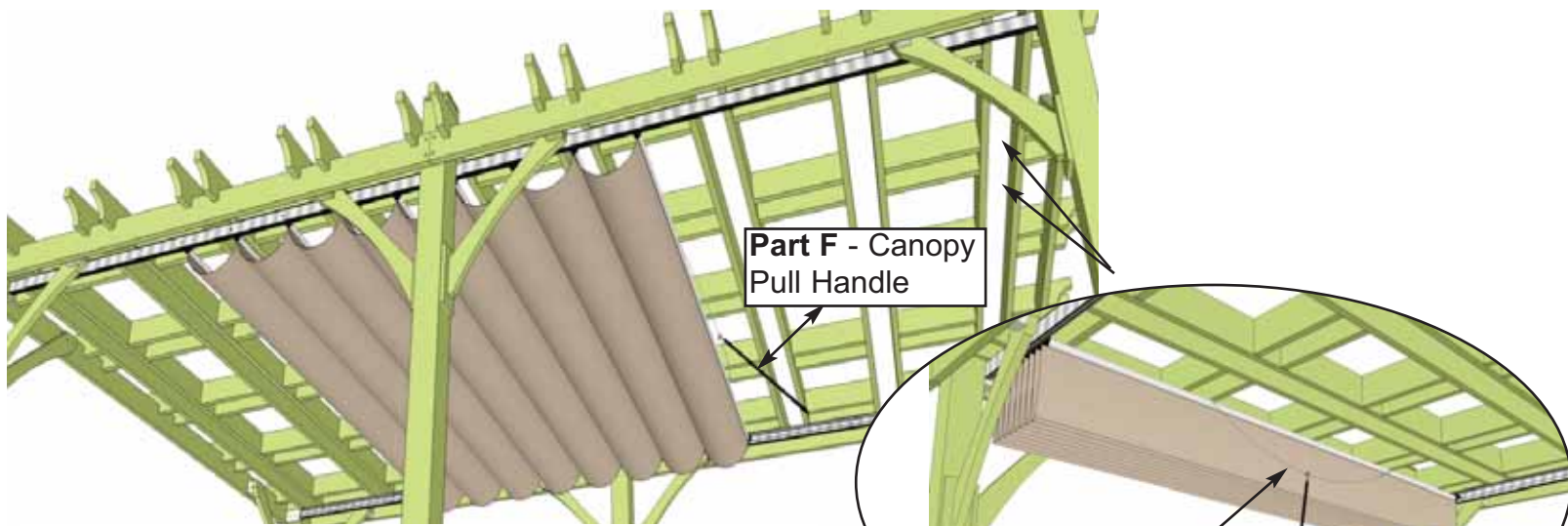

11. Using **Part F - Canopy Pull Handle**, pull canopy back and forth a few times to lubricate wheels and track. If wing binds, stop and pull forward until wings are straight and start again. When wings and canopy are tracking well, pull canopy to anchor side of pergola to install **Part D - Wing Anchor Knob**.

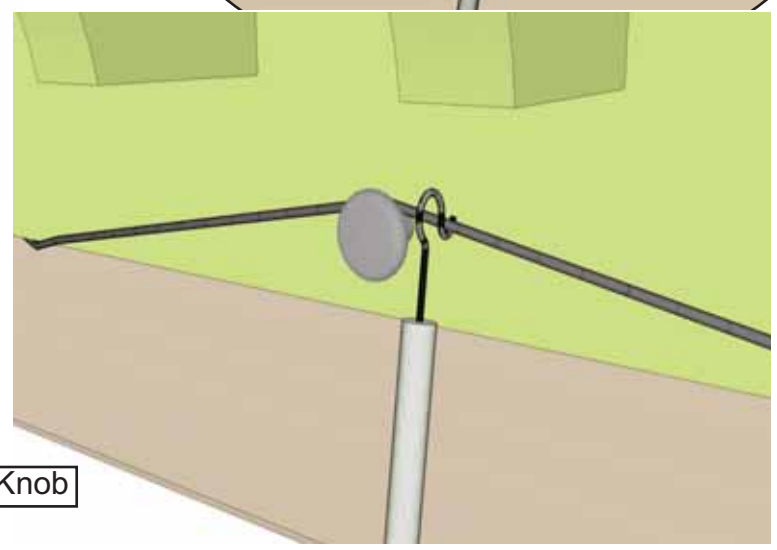
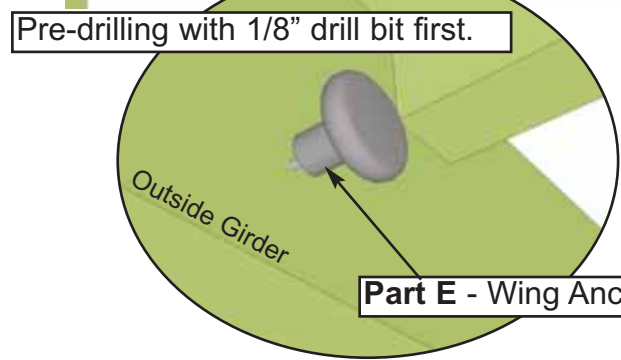
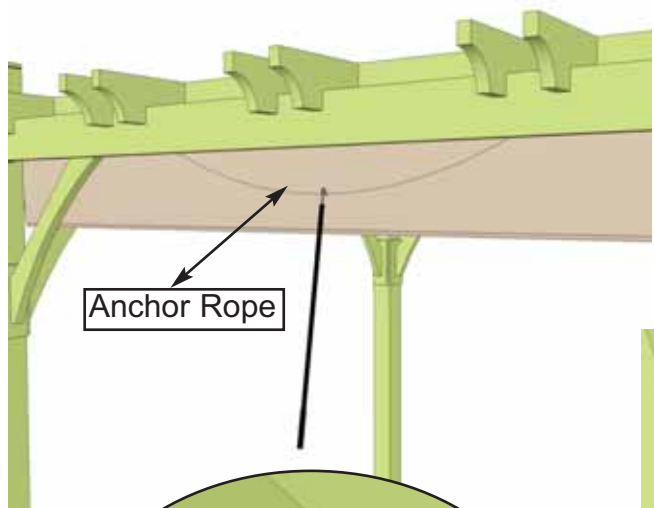
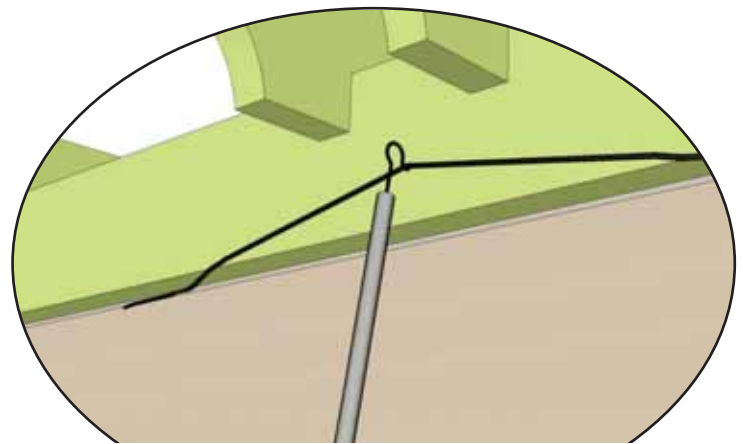
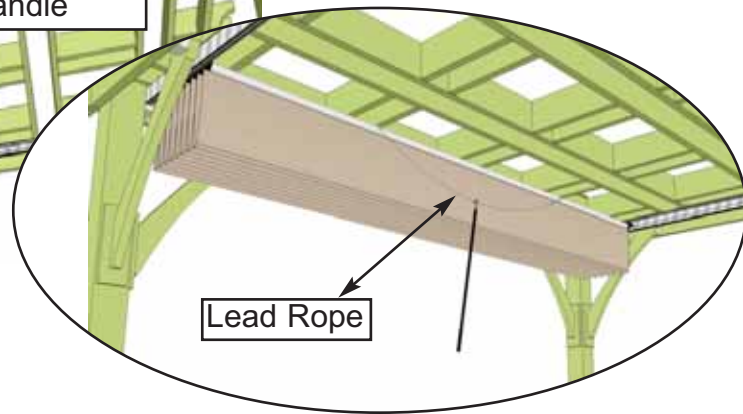

12. With canopy pull handle or hand, pull anchor rope up tight so anchor canopy wing is up against inside of pergola bracket. Center Anchor Knob from side-to-side and mark. Before attaching, make sure anchor rope will be snug when slipped over knob. Screw wing anchor knob into outside girder. Pre-drilling with 1/8" drill bit first.

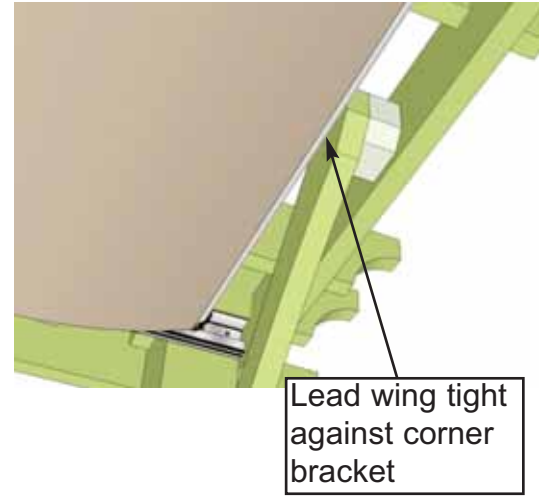
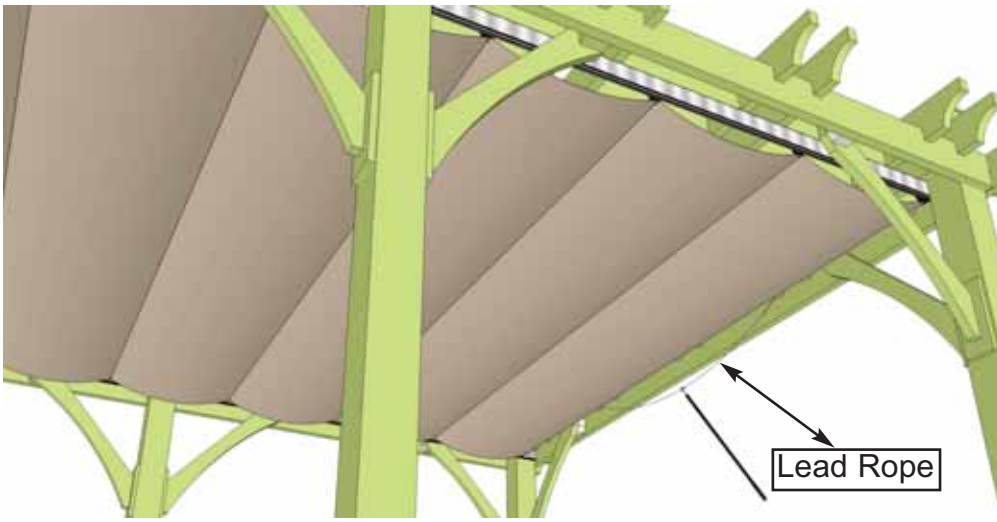

13. Pull canopy out using pull handle on lead rope. Fully extend canopy until canopy cannot extend further. Follow **Step 12** to position and attach wing anchor knob to outside girder.

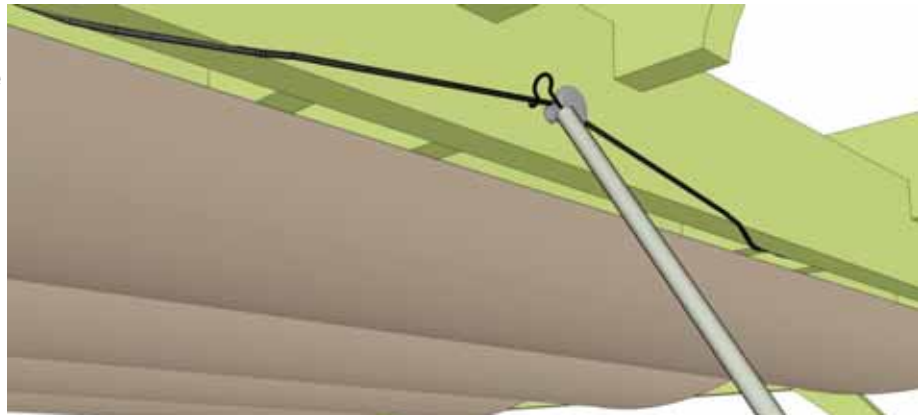

14. Extend and contract the canopy several times with pull handle. When extending or contracting the canopy, **pull** firmly in one continuous motion to prevent wings from binding.

When your canopy is contracted, an optional 3rd wing anchor knob can be installed to keep canopy from opening in windy conditions. Follow **Steps 11 and 12** to install. Use any convenient joist to install knob.

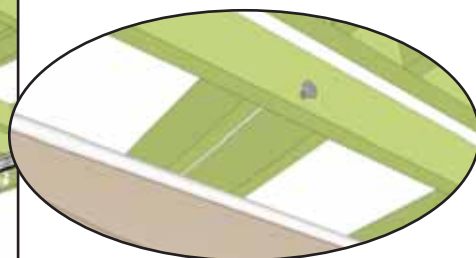
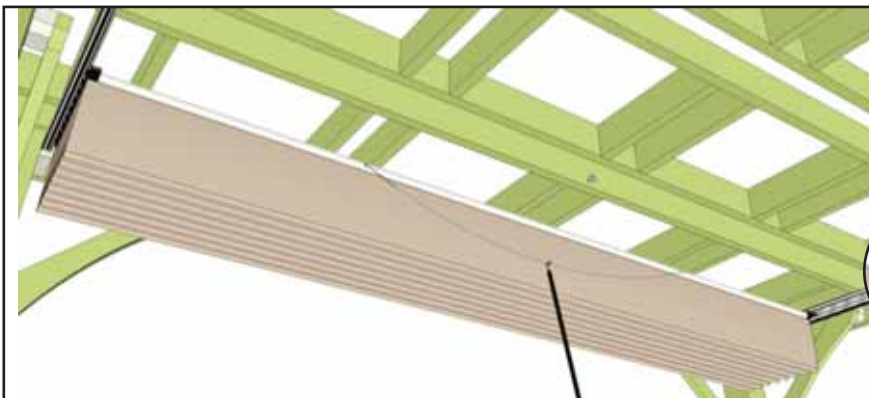

Congratulations on installing your OLM Retractable Canopy from Outdoor Living Today.



Care and Maintenance -

Do not leave canopy extended during heavy snow storms or any extreme weather conditions. Reasonable care should be taken to remove accumulated dirt and debris in track. Canopy Tracks may have sharp corners. Always use gloves when handling to prevent cuts. Lubrication (supplied in kit) of wing wheels and track should be done annually. Wing and canopy can be removed seasonally to improve longevity. To keep the Harbor-Time canopy fabric looking clean and bright, wash periodically with a soft brush, warm water and mild soap. Do not use detergent. 5 year limited manufacturer's warranty on the Harbor-Time canopy fabric.

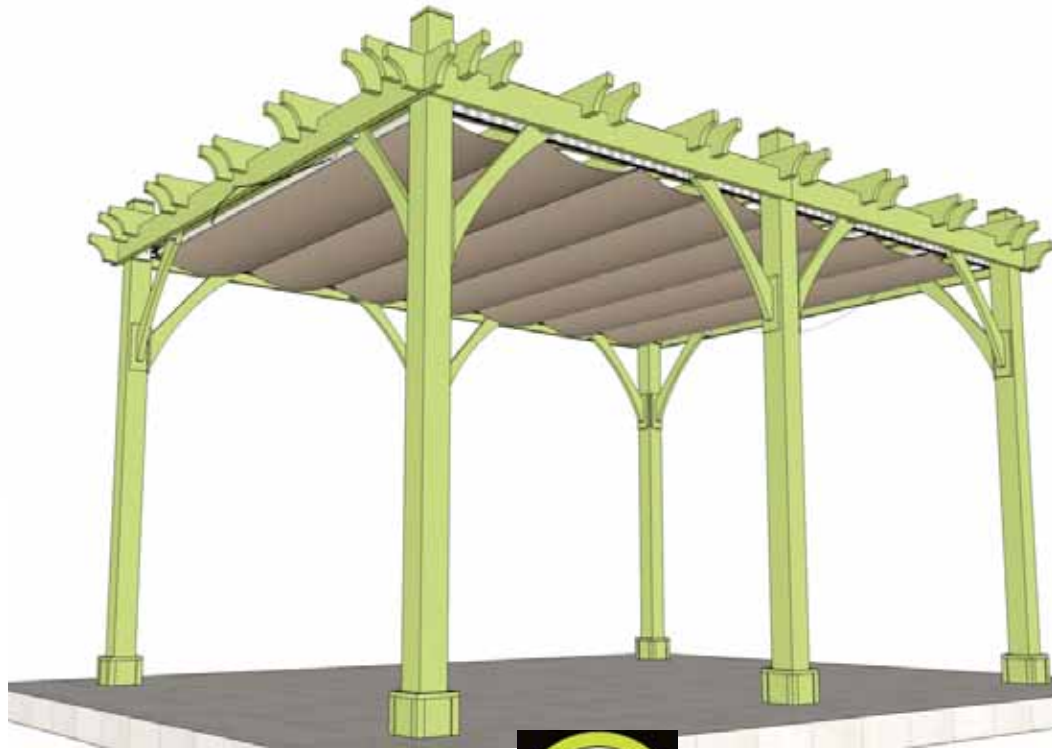

We hope your experience assembling your OLM Retractable Canopy has been both positive and rewarding.

We value your feedback and would like to hear back from you on how well we are doing in the following areas:

1. Customer Service
2. On Time Shipping
3. Motor Freight Delivery
4. Quality of Materials
5. Assembly Manual
6. Overall Satisfaction.



The materials contained in this Assembly Manual may be downloaded or copied provided that ALL copies retain the copyright and any other proprietary notices contained on the materials. No material may be modified, edited or taken out of context such that its use creates a false or misleading statement or impression as to the positions, statements or actions.

Please call, write or email us at:

Outdoor Living Today

Canadian Address
9393 287th Street
Maple Ridge, British Columbia
Canada V2W 1L1

United States Address
P.O. Box 96
Sumas, Washington
USA 98295

Toll Line: 1.888.658.1658

Fax: 1.604.462.5333

sales@outdoorlivingtoday.com