



# Assembly Manual Louvered Panels For Breeze Pergola

## 12x12 & 12x16 & 12x20 Models

### Outdoor Living Today

Revision #3  
November 12, 2020

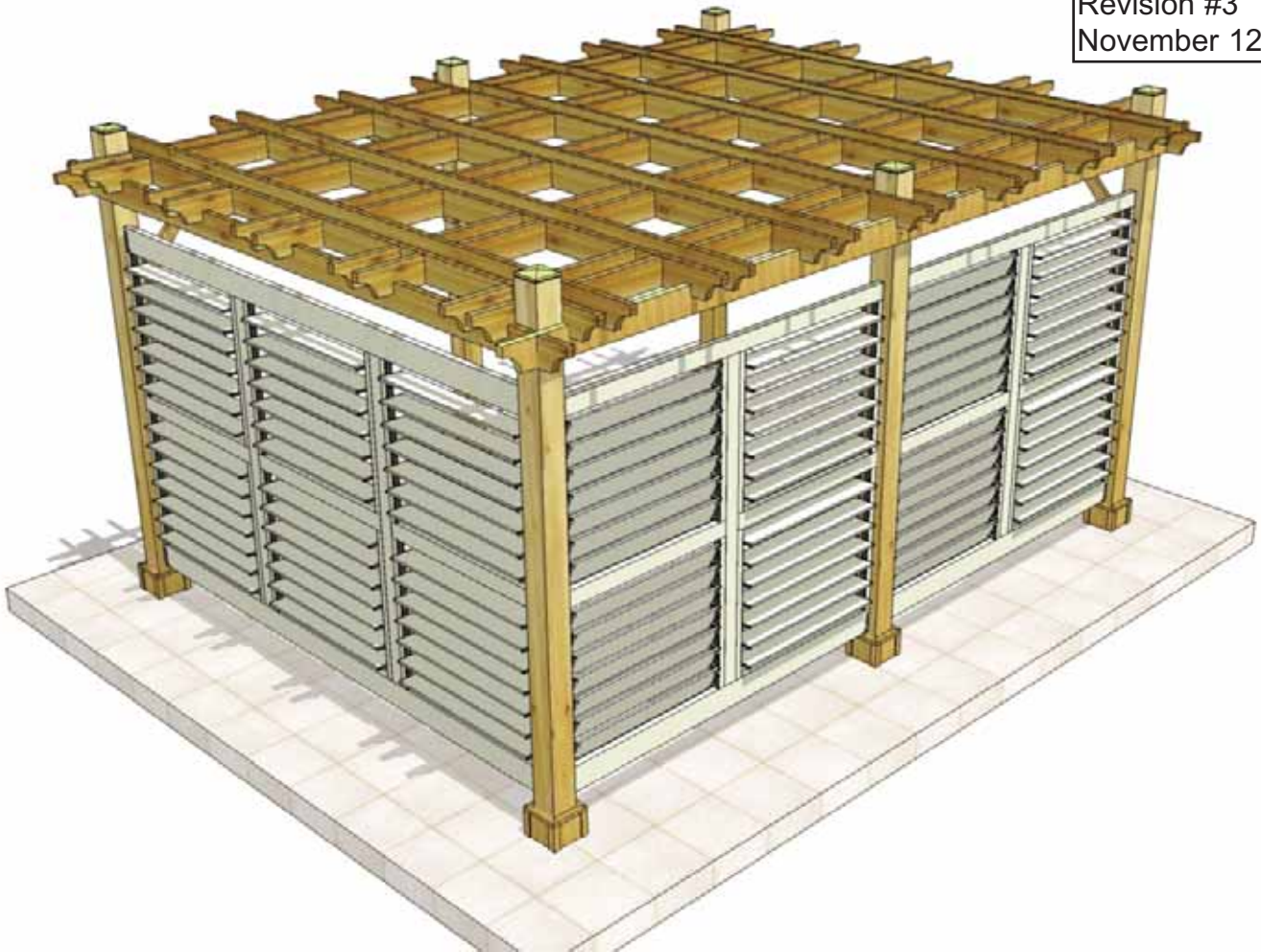

Customers agree to hold Outdoor Living Today and any Authorized Dealers free of any liability for improper installation, maintenance and repair of any Outdoor Living Today products.

In the event of a missing or broken piece, simply call the Outdoor Living Today Customer Support Line @ 1-888-658-1658 within 30 days of the delivery of your purchase. It is our commitment to you to courier replacement parts, free of charge, within 10 business days of this notification. Replacement parts will not be provided free of charge after the 30 day grace period.

## Exploded Parts List

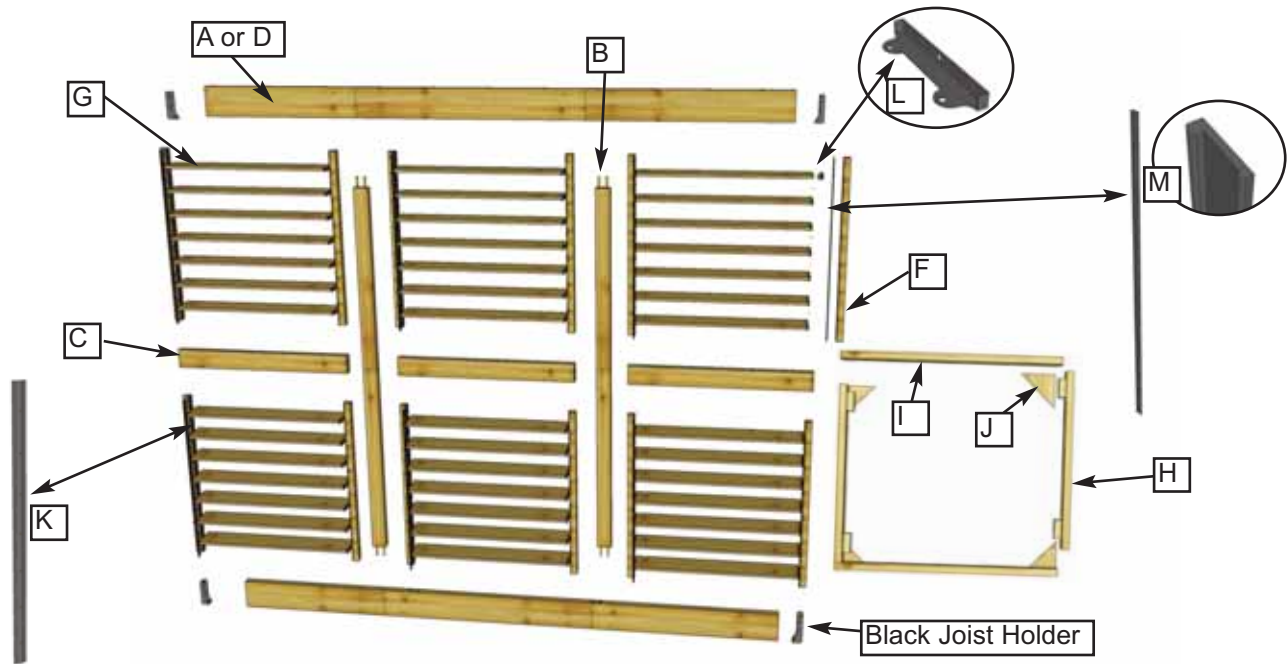

### Care and Maintenance -

Check annually that all screws are secure. Tighten if necessary.

We recommend staining or painting all the Wester Red Cedar Louvered Parts prior to assembly. Please check with your local stain and paint dealer to confirm what product is best in your area.

### Tools Required (Not Provided)



Screw Gun/Drill



Level



Tape Measure



Wood Clamp



Ladders

### Safety Equipment Required (Not Provided)



Safety Glasses



Work Gloves

# Louvered Panels for Breeze Pergola Parts List

## Per 12ft Section

### Lumber Pieces

#### 12ft Section

- A - 1.5" x 5.5" x 132 7/8" - 2 pcs - Bottom/Top Joist- Pre-drilled
- B - 1.5" x 3.5" x 69 1/2" -2 pcs - Vertical Posts - Drilled for Dowels
- C - 1.5" x 3.5" x 41 7/8" - 3 pcs - Hor. Rails
- F - 1.5" x 1.5" x 33" -12 pcs - Vertical Louvered Framing
- G - 11/16" x 5.5" x 37 5/8" - 42 pcs Louvered Slats

### Louvered Pieces

#### 12ft Section

- K - Plastic Rails - 33" - 12 pcs
- L - Slat Mounts - 84pcs
- M - Connecting Rods -33" - 12 pcs
- Black Slat Mount/2x2 Framing Screws - 1 1/2" long - 84 pcs
- Black Slat Mount/Louvered Screws - 5/8" long - 168 pcs
- Black Rod Screws - 3/4" long - 84 pcs

### Additional Hardware

#### 12ft Section

- 2.5" Brown Screw Total = 66 pcs
  - 2.5" Brown Screws - 36 pcs - Plastic Rails
  - 2.5" Brown Screws - 16 pcs - Joist Holders
  - 2.5" Brown Screws - 14 pcs - All Framing
- 3/8" diameter x 3" dowels - 8 pcs
- Black Joist Holders - 4 pcs

## Per 16ft Section

### Lumber Pieces

- C-1.5" x 3.5" x 41 7/8" - 4 pcs - Hor. Rails
- D-1.5" x 5.5" x 87 5/8" - 4pcs - Bottom/Top Joists- Pre-drilled
- B-1.5" x 3 1/2" x 69 1/2"- 2pcs Vertical Posts-Drilled for Dowels
- F - 1.5" x 1.5" x 33" - 16pcs - Vertical Louvered Framing
- G - 11/16" x 5.5" x 37 5/8" - 58 pcs Louvered Slats

### Louvered Pieces

- K - Plastic Rails - 33" - 16 pcs
- L - Slat Mounts - 112pcs
- M -Connecting Rods -28" - 16 pcs
- Black Slat Mount/2x2 Framing Screws - 1 1/2" long - 112 pcs
- Black Slat Mount/Louvered Screws - 5/8" long - 224 pcs
- Black Rod Screws - 3/4" long - 112 pcs

### Additional Hardware

#### 16ft Section

- 2.5" Brown Screw Total = 104 pcs
  - 2.5" Brown Screws - 48 pcs - Plastic Rails
  - 2.5" Brown Screws - 32 pcs - Joist Holders
  - 2.5" Brown Screws - 24 pcs - All Framing
- 3/8" diameter x 3" dowels - 8 pcs
- Black Joist Holders - 8 pcs

## Per 20ft Section

### Lumber Pieces

- C-1.5" x 3.5" x 54 1/4" - 4 pcs - Hor. Rails
- D-1.5" x 5.5" x 111 5/8" - 4pcs - Bottom/Top Joists- Pre-drilled
- B-1.5" x 3 1/2" x 69 1/2"- 2pcs Vertical Posts-Drilled for Dowels
- F - 1.5" x 1.5" x 33" - 16pcs - Vertical Louvered Framing
- G - 11/16" x 5.5" x 50 1/2" - 58 pcs Louvered Slats

### Louvered Pieces

- K - Plastic Rails - 33" - 16 pcs
- L - Slat Mounts - 112pcs
- M -Connecting Rods - 28" - 16 pcs
- Black Slat Mount/2x2 Framing Screws - 1 1/2" long - 112 pcs
- Black Slat Mount/Louvered Screws - 5/8" long - 224 pcs
- Black Rod Screws - 3/4" long - 112 pcs

### Additional Hardware

#### 20ft Section

- 2.5" Brown Screw Total = 112 pcs
  - 2.5" Brown Screws - 48 pcs - Plastic Rails
  - 2.5" Brown Screws - 32 pcs - Joist Holders
  - 2.5" Brown Screws - 24 pcs - All Framing
- 3/8" diameter x 3" dowels - 8 pcs
- Black Joist Holders - 8 pcs

### Jig

- H-1.5" x 3.5" x 33" - 2pcs -Vertical Frame with Supports Attached
- I - 1.5" x 3.5" x 56 3/4" - 2 Pcs - Hor. Frames
- J- Triangle Corners Made with Hardboard (7" x 7")
- Hardware
  - 8 - 2.5" Brown Screws for Framing
  - 12 - 1.25" Brown Screws for Corners

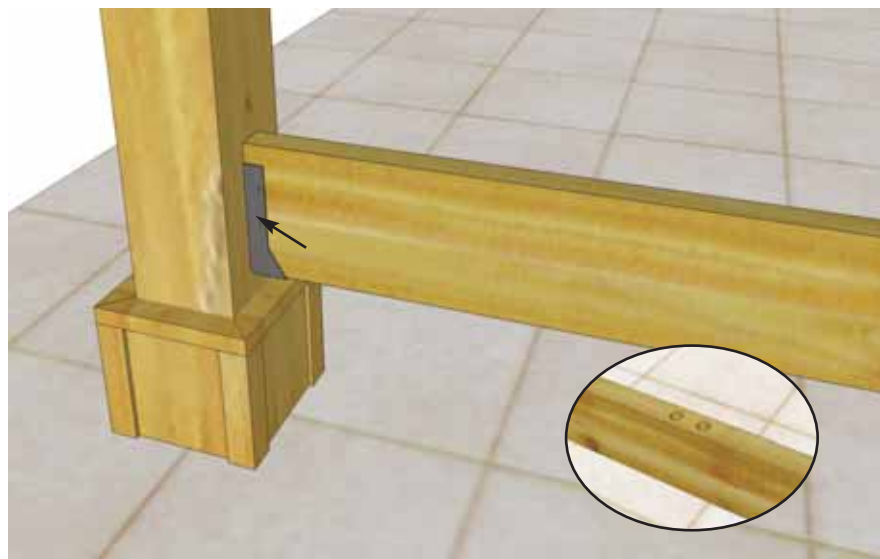

**1.** Height of the finished Louvered Panel is 80 1/2". Mount bottom of 1 **Black Joist Holder** at your desired height and centered on the Post with 4 - 2 1/2" screws. Illustration above shows Holder mounted approximately 1" above Post Skirting. Slide **Part A - Bottom Joist** into Holder. Make sure drilled holes for Dowels in Joist are facing up. Secure **Joist, Holder** and **Post** together using 2 - 2 1/2" screws.

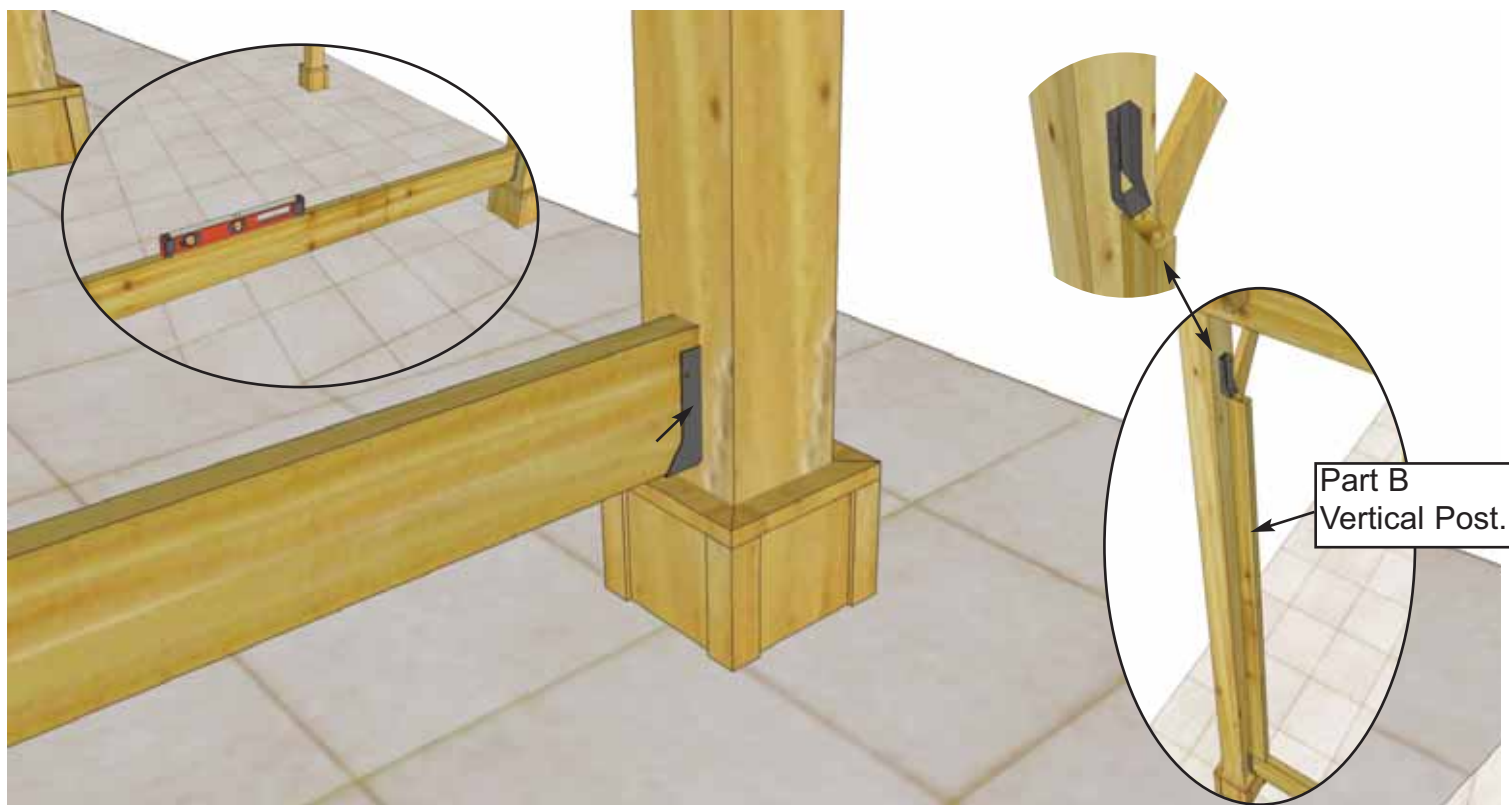

**2.** Position opposite end **Joist Holder** under **Joist**, level **Joist** and secure Holder to **Post**. Attach as per Step 1. Using **Part B - Vertical Post** to determine height of top **Black Joist Holder**, attach when in correct position as per Step 1. Complete both sides.

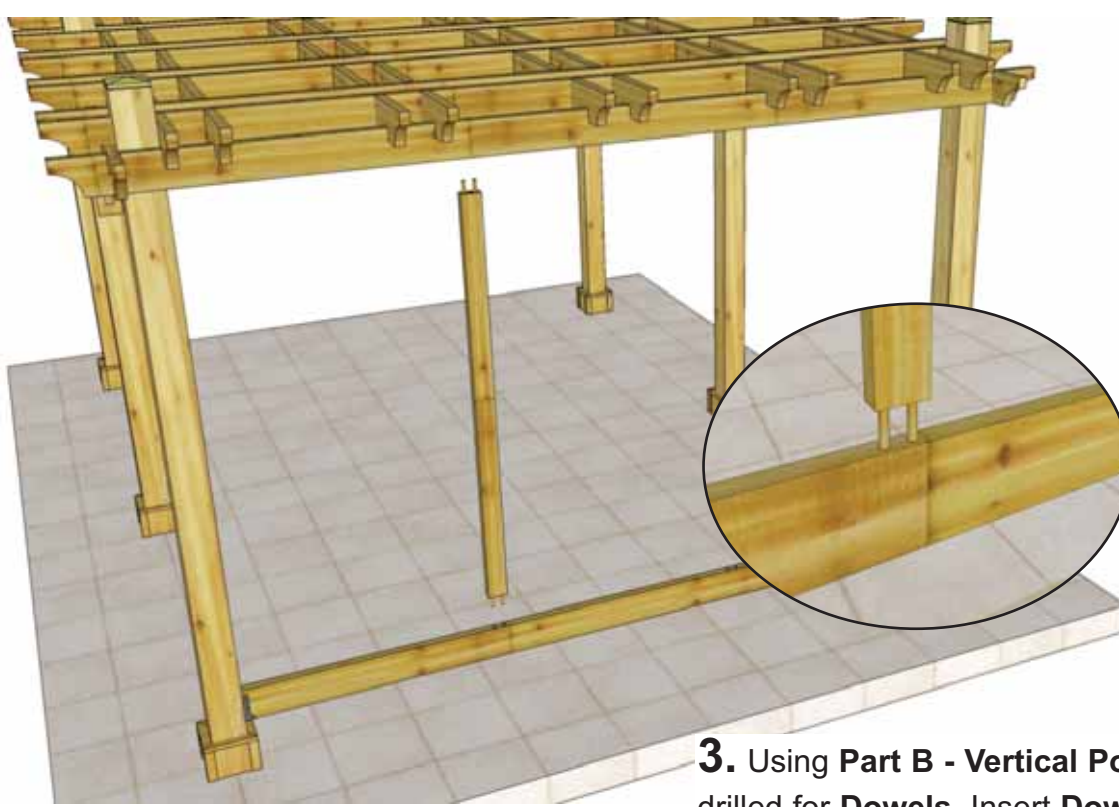

Post and Joist tight.

**3.** Using **Part B - Vertical Post** with ends drilled for **Dowels**. Insert **Dowels** in both **Post** ends. Push **Post** with **Dowels** into pre-drilled holes of **Joist** until end of **Post** and edge of **Joist** are flush. Complete both **Vertical Posts**.

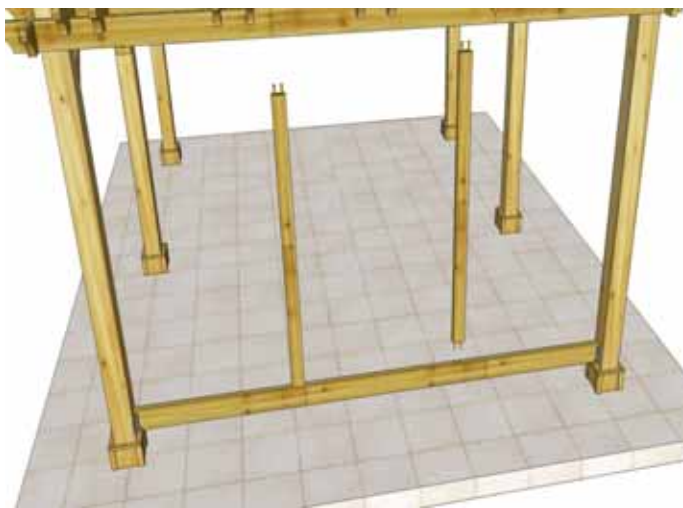

**4.** Lift and position **Part A - Top Joist** with **Dowel Holes** down into **Vertical Post Dowels** until **Joist** and **Post** are tight together.

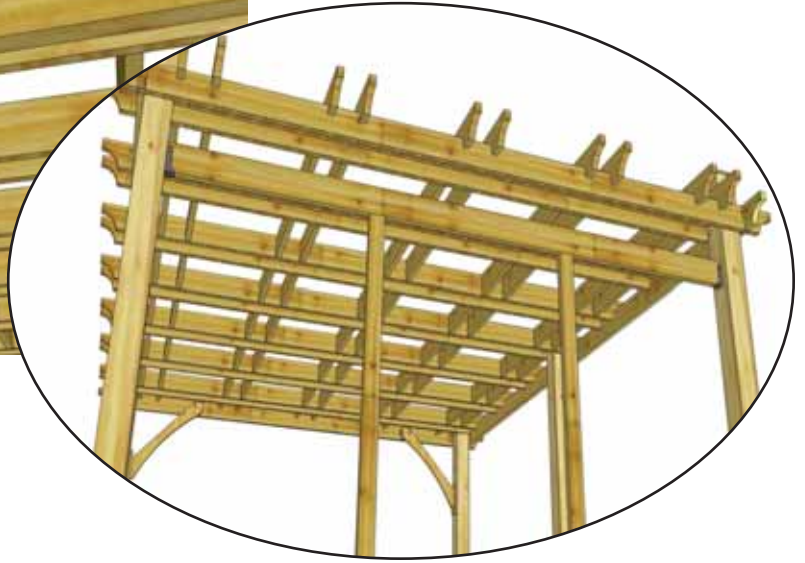

**5.** Secure **Joist, Holder** and **Post** together using 4 - 2 1/2" screws per side.

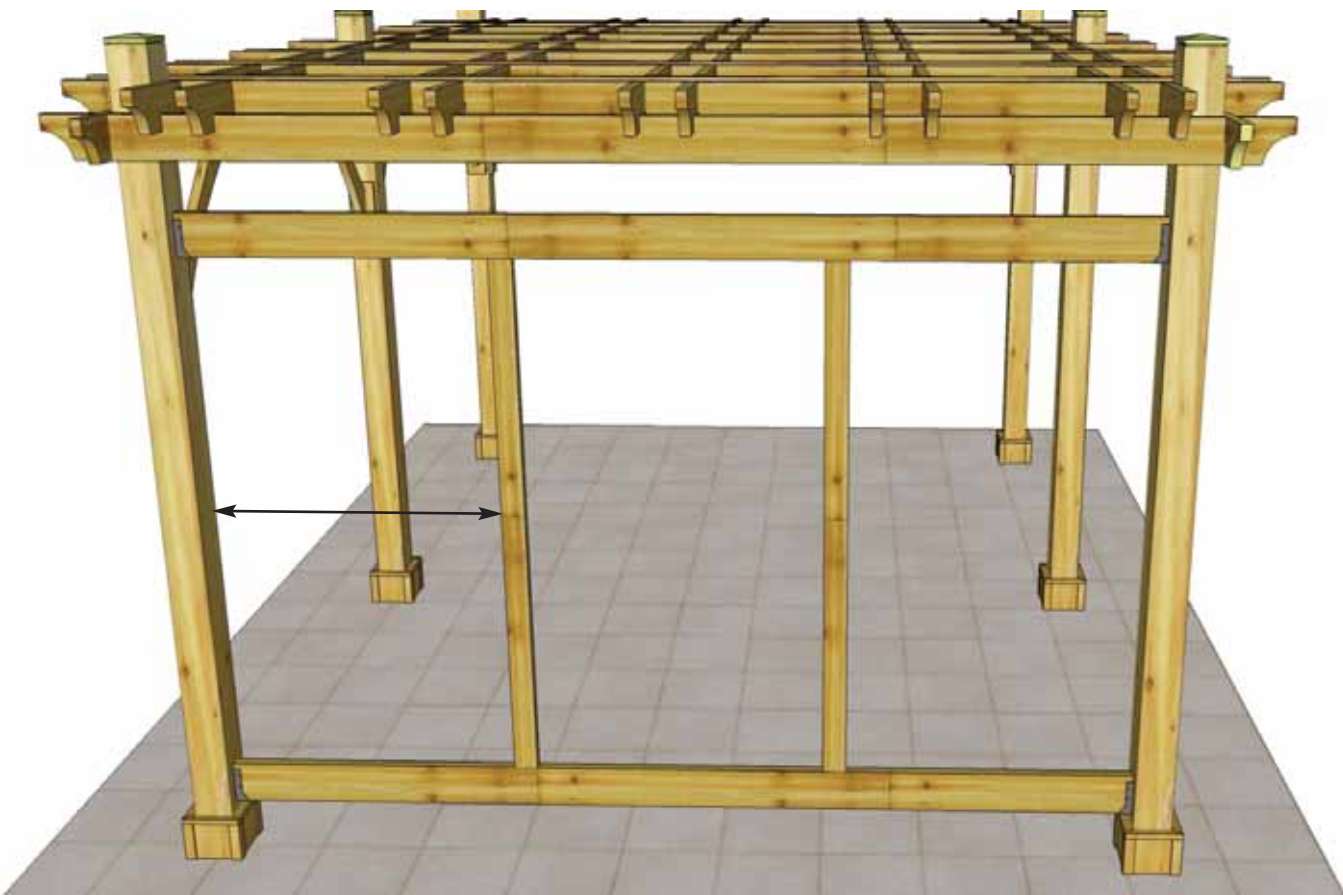

**6.** Before proceeding to **Step 7 (Jig Assembly)**, measure the width of each Louver Section. There could be a slight variation in width between each section. Jig Width may need adjustment if your Pergola Post to Post measurement is off. To do so, remove top and bottom screws of one side of the Jig, reposition and screw back together. Use **Part C - Horizontal Rails** to also confirm width of Louvered Sections. See **Step 22** for further details.

**7.** Locate all parts for Louvered Jig -

- Part H - Vertical Frame with Supports Attached (2),**
- Part I - Horizontal Frames (2) and**
- Part J - Triangle Corners Made with Hardboard (4 @ 7" x 7")**

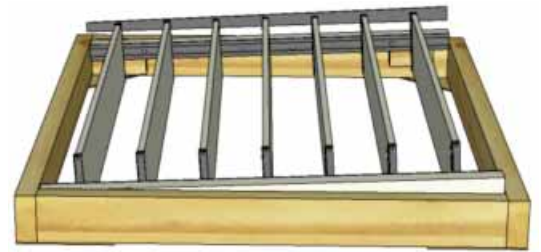

**Note:** Jig will be used to assemble Louvered Panels as shown above. The angled support pieces are designed to give better accessibility during assembly.

Part I - Horizontal Frame.

Part H - Vertical Frame.

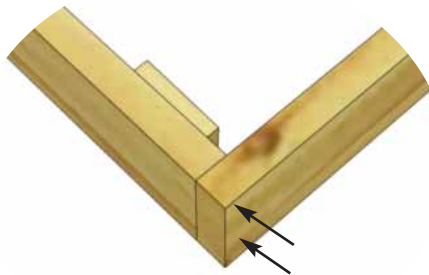

Each Part H has two angled support pieces. Ensure they are installed with the same orientation on both sides.

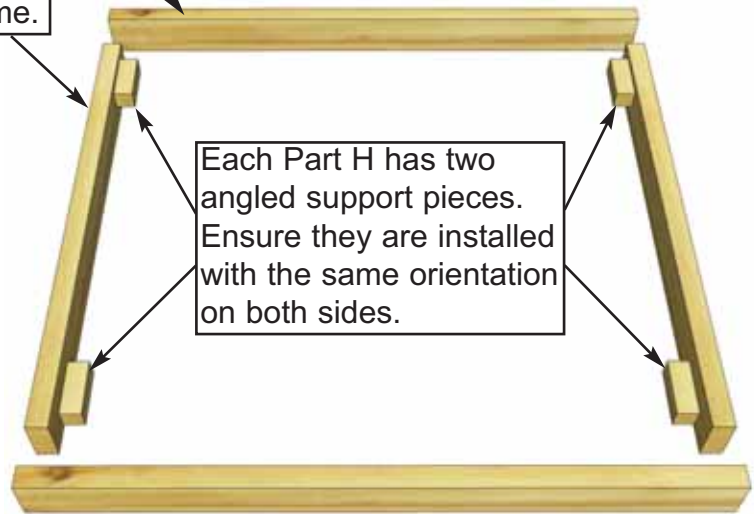

Attach **Jig** together with 2 - 2 1/2" Screws in each corner. Pre-drill first with 1/8" bit to prevent wood from splitting.

Part J - Triangle Corners.

Flip over to attach corner pieces.

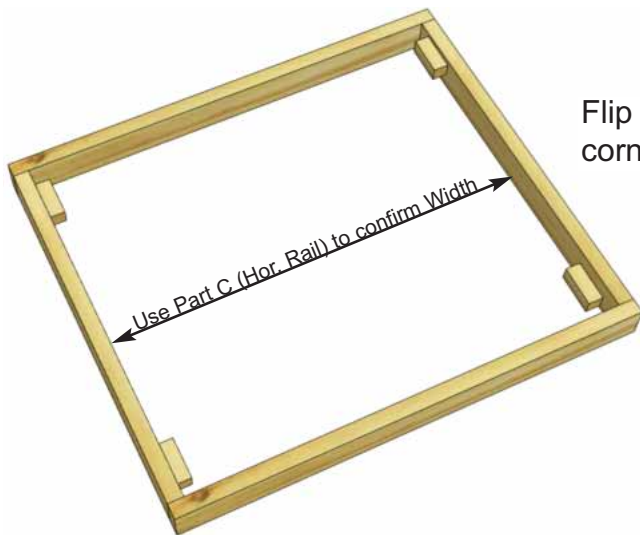

Use Part C (Hor. Rail) to confirm Width

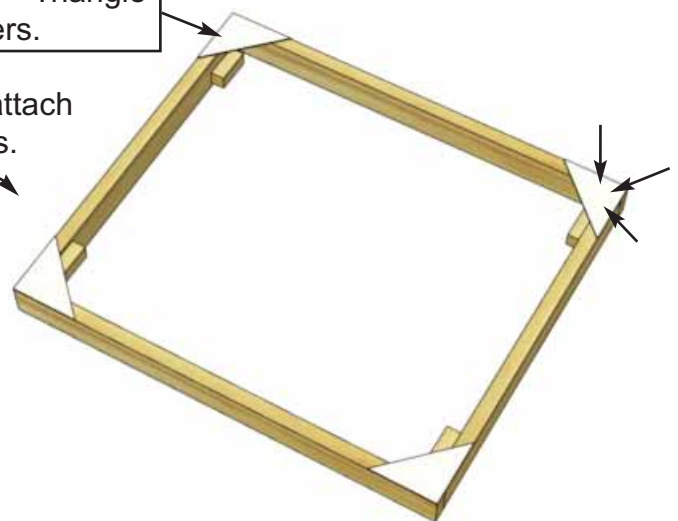

**8.** With **Jig** sized and screwed together, attach **Part J - Triangle Corners** with 3 - 1 1/4" screws. **Corners** will keep Jig square. When all **Corners** are complete, flip Jig over so **Corners** are now on the bottom.

**Note** - There is only 1 **Jig** to complete all Louvered Panels. As mentioned, **Jig** may need to be partially dis-assembled, re-sized and then assembled again for different Louvered Sections.

Flip back over

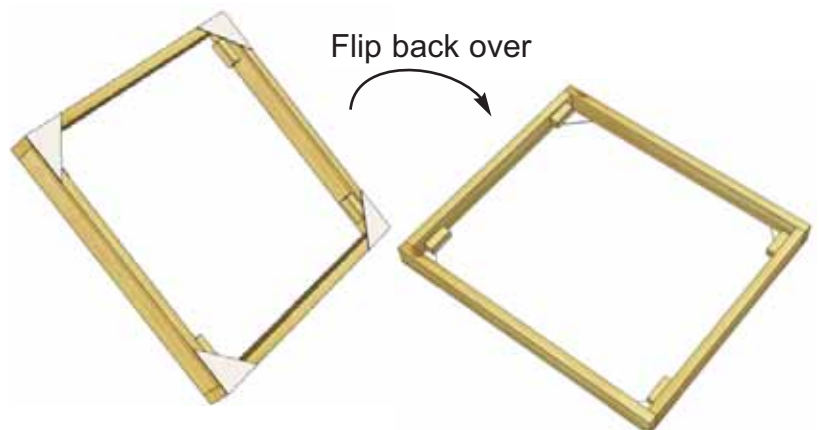

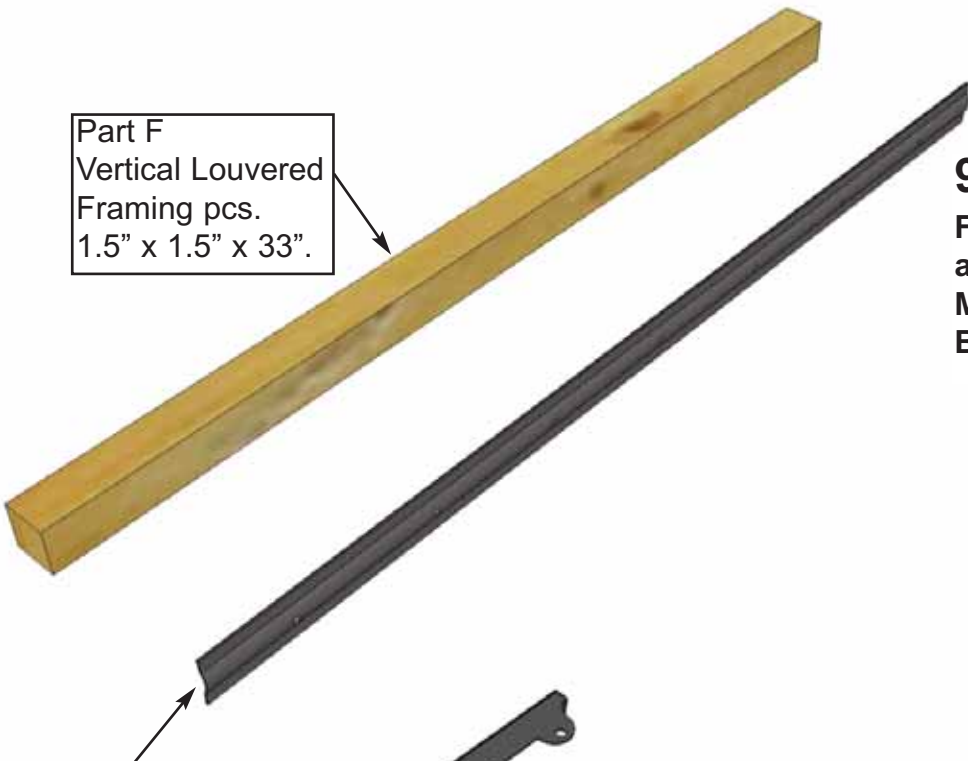

Part F  
Vertical Louvered  
Framing pcs.  
1.5" x 1.5" x 33".

Part K  
Plastic Rails.  
33" long.

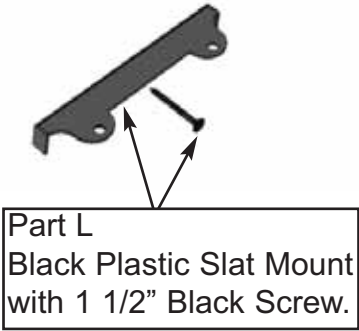

Part L  
Black Plastic Slat Mount  
with 1 1/2" Black Screw.

**9.** Locate **Part F - Vertical Louvered Framing piece, Part K - Plastic Rail and Part L - Black Plastic Slat Mounts (7 pieces) with 7 - 1 1/2" Black Screws.**

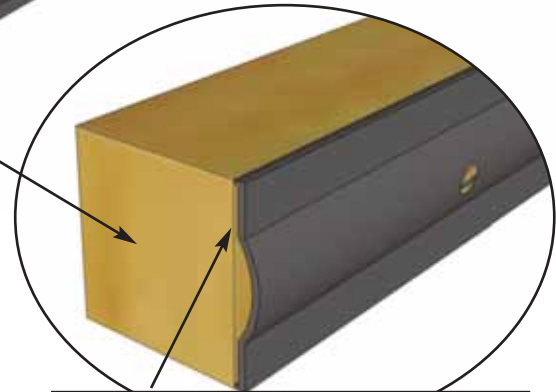

Position **Plastic Rail** so end is flush with end of **Wooden Louvered Framing** and centered on it.

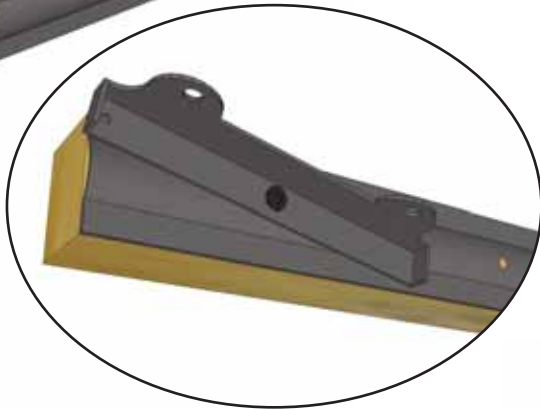

**10.** Position **Part L - Slat Mount** and attach with 1 1/2" **Black Screw** as shown above. Do opposite end next.

**Important - do not over-tighten Slat Mount.** Tighten so **Slat Mount** can swivel with slight resistance.





**11.** Complete remaining Slat Mount (5) connections.

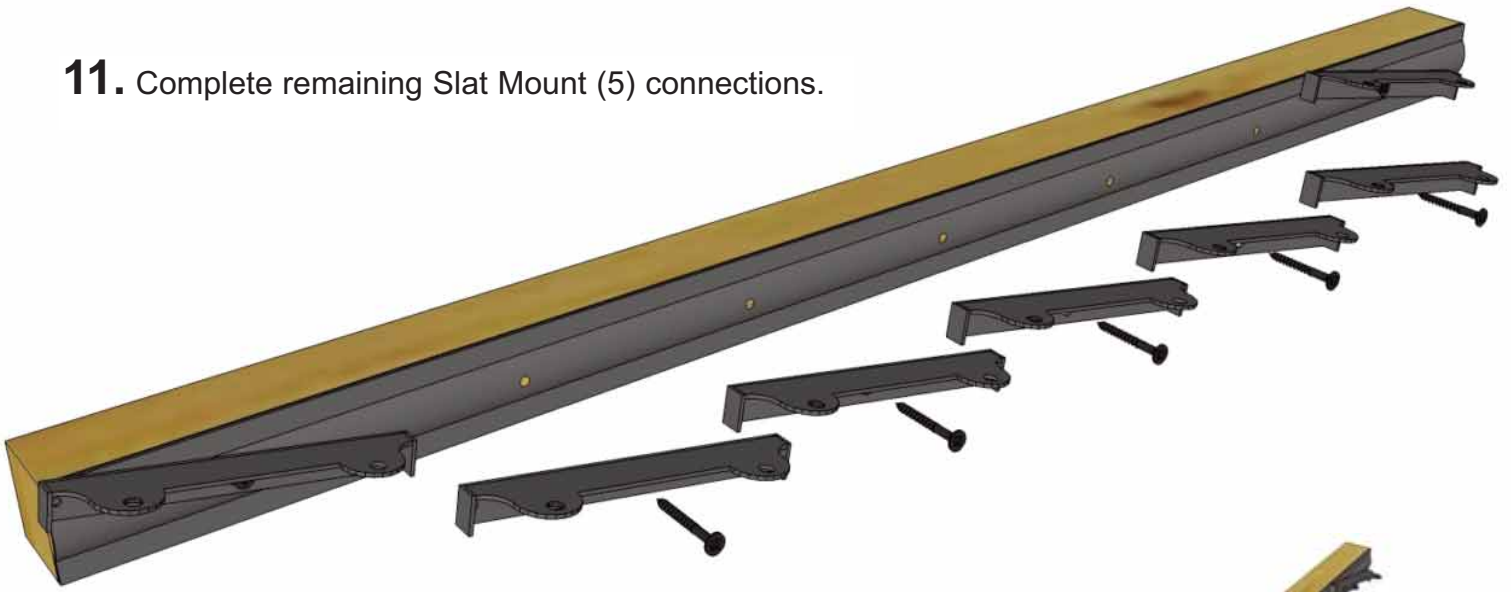

**12.** Complete remaining Rail/Slat Mounts.  
(12 in total).



**13.** Drop two completed Rail/Slat Mounts into the Jig with the Slat Mounts facing in as shown above.

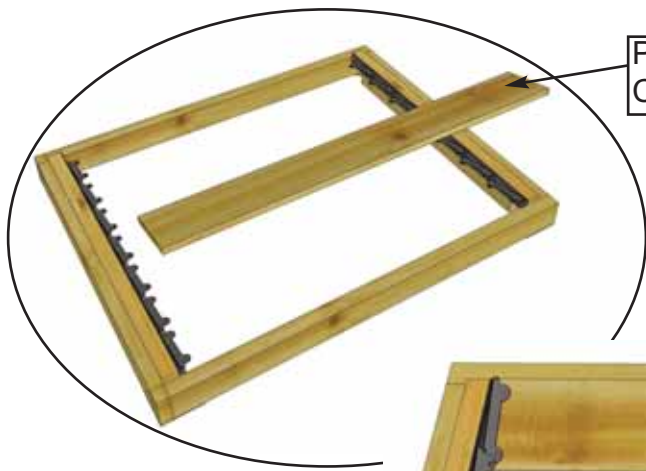

Part G  
Cedar Louvered Slat.

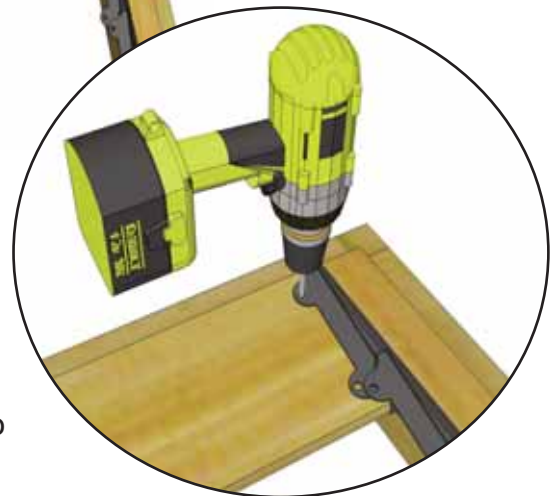
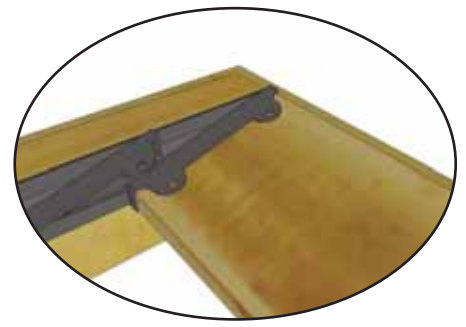

**14.** Locate **Part G - Louvered Slats** . Slide the First Slat between **Slat Mounts** as shown above. Having a helper will be useful. Pre-drill slat with 1/16" bit to prevent wood from splitting. Secure each Slat with **4 - 5/8" Black Screws**.

**Note** - Before securing Slats, observe how each is manufactured. Edges on faces can be slightly different. Sort and orientate all Slats so when creating your Louvered Panel all are orientated similarly.



**15.** Slip next **Louvered Slat** between **Slat Mounts** (Total of 7 / panel). Align and attach as per **Step 14**. Complete remaining Slats.

**16.** With all **Louvered Slats** attached, rotate each Slat so they are aligned perpendicular to the **Louvered Framing** as shown below.



Part M  
Connecting Rod.

**17.** Locate **Part M - Connecting Rod** and align hole in Slat Mount with hole in Rod. Attach with **3/4" Black Screw**. Complete all attachments.

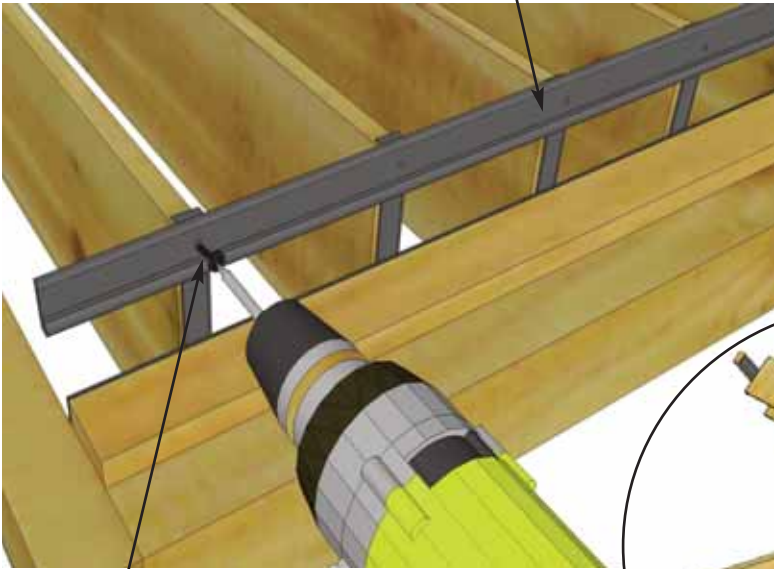

3/4" Black Screw.



2nd Connecting Rod.

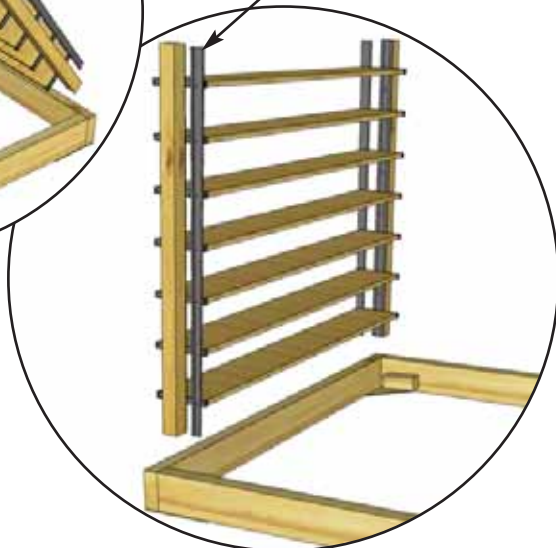

**18.** To complete panel, carefully lift out of Jig and install second **Connecting Rod** as per **Step 17**.

**Complete 2nd (Top) Louvered Panel now. See Step 21.**

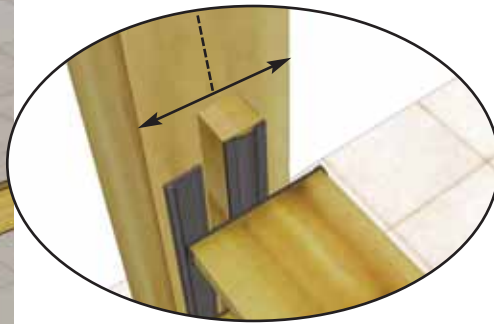
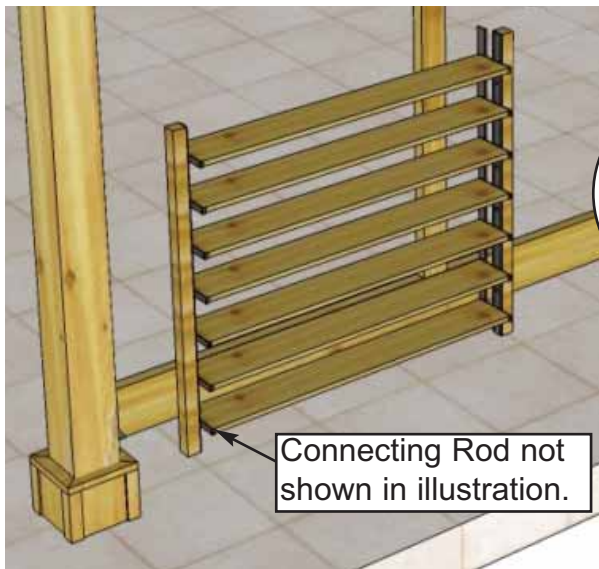

**19.** Carefully lift completed Louvered Panel and position so it sits evenly on Bottom Joist and centered on both the **Post of the Pergola** and the **Vertical Post of the Louvered Framing**.

Note there are 3 pre-drilled holes in **Plastic Rails (K)**. When aligned, screw **Vertical Louvered Framing (F)** into both Posts with 3 - 2 1/2" Brown Screws per side.

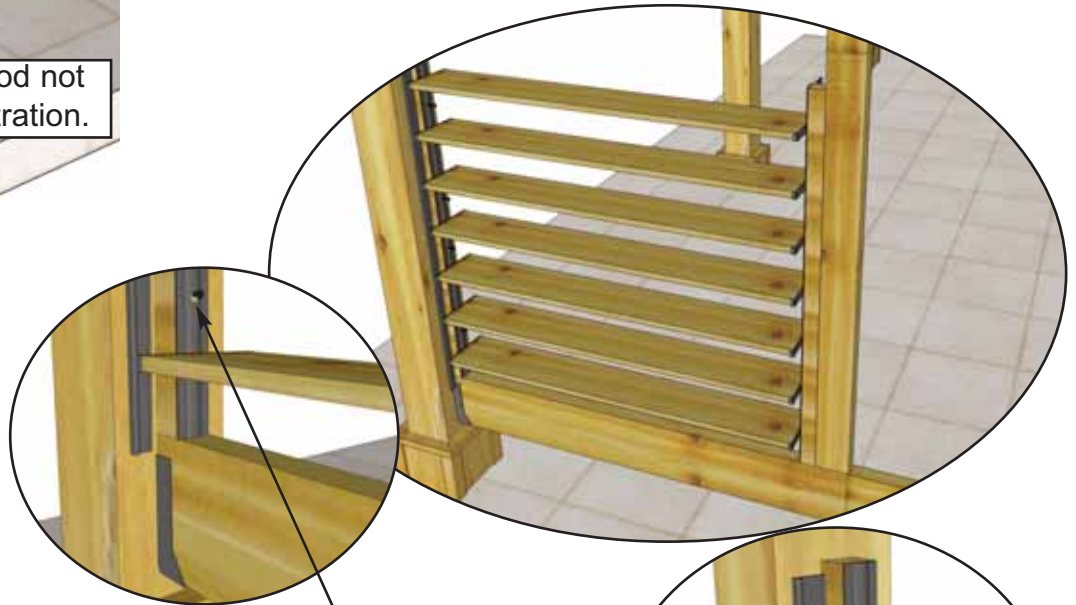

Pre-drilled holes for 2 1/2" Brown Screws.

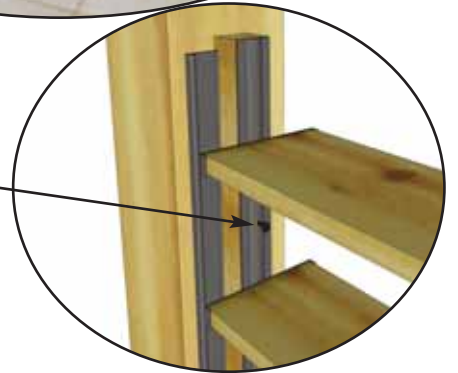

Angle screw **Rail to Posts** with 1 - 2 1/2" Brown Screw per side. Pre-drill 1/8" pilot hole first to prevent wood splitting.

Hor. Rail (Part C).

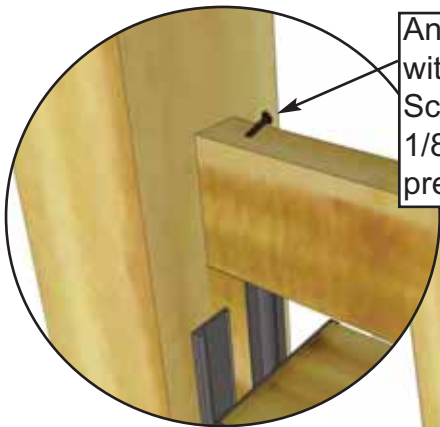

**20.** Position **Part C - Horizontal Rail** so it sits tight against the top of **Vertical Louvered Framing (F)**. Angle screw Rail to Posts with 1 - 2 1/2" Brown Screw per side. Pre-drill Rail with 1/8" drill bit to prevent wood from splitting.

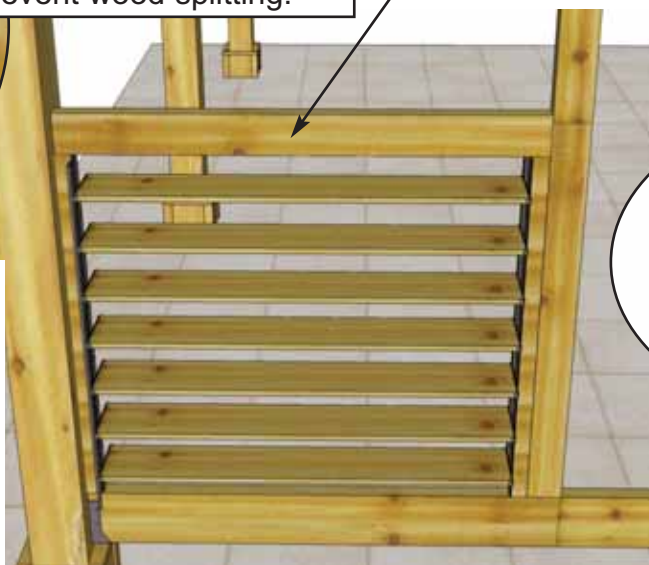

**21.** Position and attach top Louvered Panel between Rail, Posts and Joist as per **Step 20**.

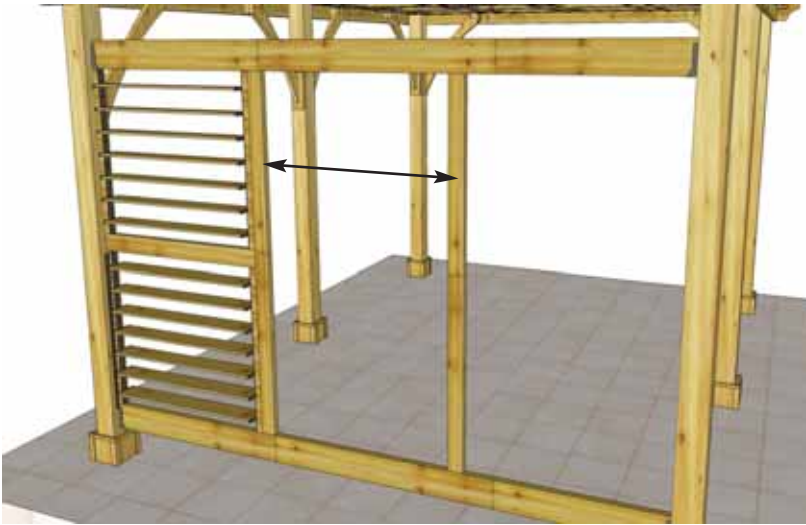

**22.** Before completing next Louvered Panel Section, take a measurement between **Posts** to confirm proper **Jig** Width. Adjustment to Jig may be necessary before proceeding.

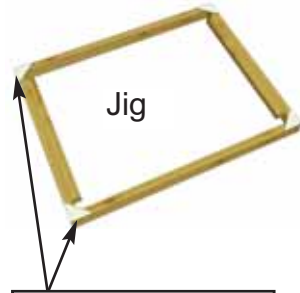

If required, remove Corners, unscrew frame and re-position.

**Horizontal Rail** may need to be trimmed slightly to fit between Posts.

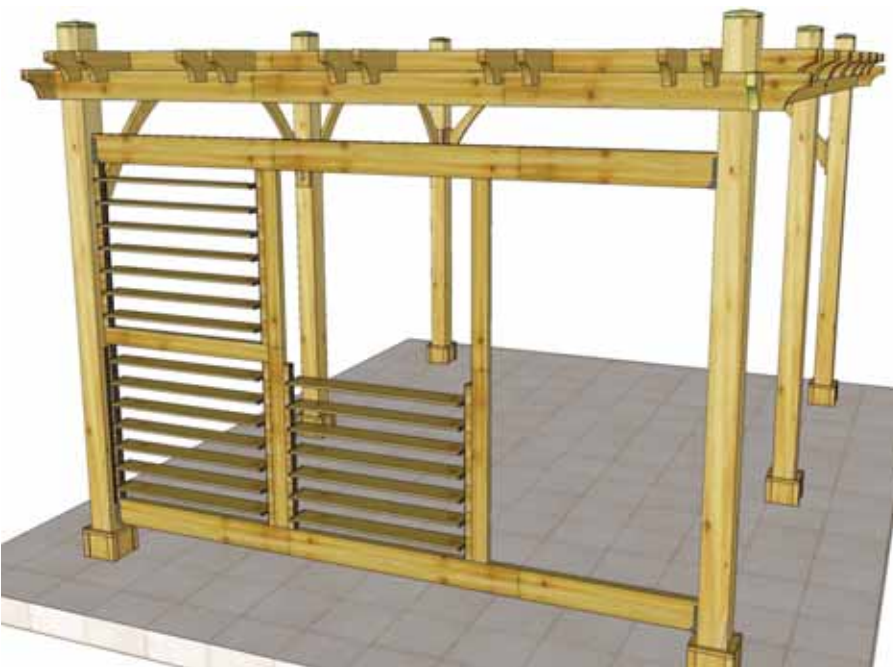

**23.** Complete Louvered Panel Assembly as per **Steps 14-19** and install next section.

**24.** Complete top Louvered Panel Assembly as per **Steps 20-21.**



**25.** Measure final Section width once again and follow **Steps 14-22** to complete Wall Side.

**26.** If completing a 16ft or 20ft side, note that there is only 1 Vertical Post in each Section. Follow instructions laid out above to complete 8ft or 10ft Section.

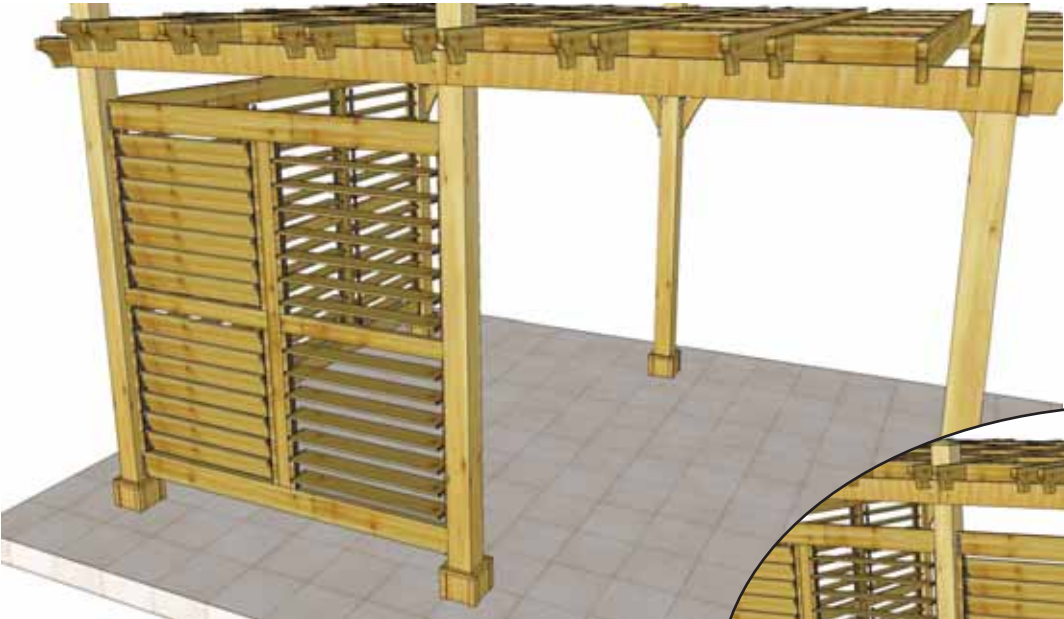
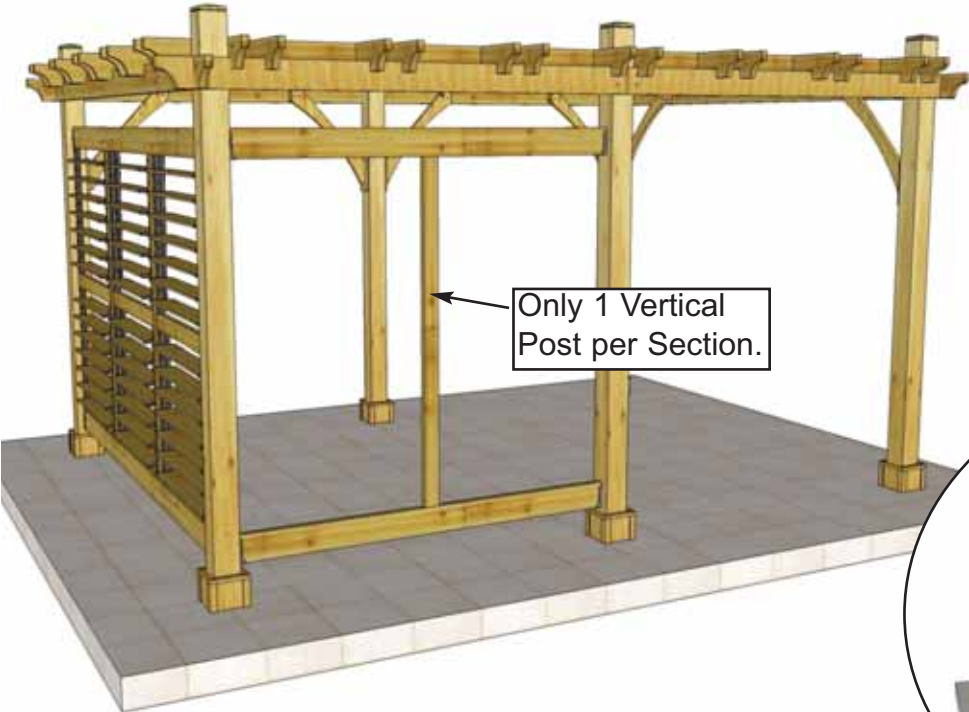

**27.** Complete both 8ft or 10ft Sections to finish your Louvered Pergola Panels!

# Congratulations on installing your Louvered Pergola Panels for a Breeze Pergola from Outdoor Living Today!



## Care and Maintenance -

Check annually that all screws are secure. Tighten if necessary.

We recommend staining or painting all the Wester Red Cedar Louvered Parts prior to assembly. Please check with your local stain and paint dealer to confirm what product is best in your area.

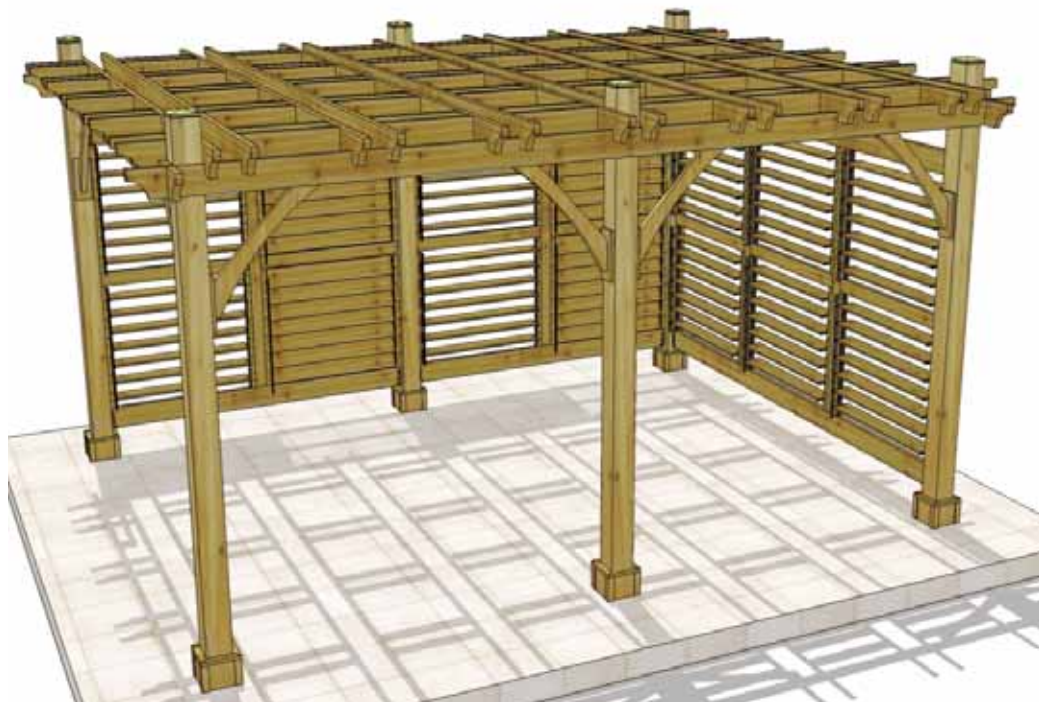

We hope your experience assembling your pergola has been both positive and rewarding.

We value your feedback and would like to hear back from you on how well we are doing in the following areas:

1. **Customer Service**
2. **On Time Shipping**
3. **Motor Freight Delivery**
4. **Quality of Materials**
5. **Assembly Manual**
6. **Overall Satisfaction.**



The materials contained in this Assembly Manual may be downloaded or copied provided that ALL copies retain the copyright and any other proprietary notices contained on the materials. No material may be modified, edited or taken out of context such that its use creates a false or misleading statement or impression as to the positions, statements or actions.

Please call, write or email us at:

Outdoor Living Today

Canadian Address  
9393 287th Street  
Maple Ridge, British Columbia  
Canada V2W 1L1

United States Address  
P.O. Box 96  
Sumas, Washington  
USA 98295